

Mathematics

Grade 9

Government of Nepal

Ministry of Education, Science and Technology

Curriculum Development Centre

Sanothimi, Bhaktapur

Publisher: Government of Nepal
Ministry of Education, Science and Technology
Curriculum Development Centre
Sanothimi, Bhaktapur

© Publisher

All rights reserved. No part of this publication may be reproduced or transmitted in any other form or by any means without the written permission of the publisher. However, this does not prohibit making copies of its pages for teacher training or other not-profit making purposes.

First Edition: 2022 AD

Price:

Printed at: Janak Education Materials Centre Ltd.
Sanothimi, Bhaktapur

Send your comments and suggestions to:
Curriculum Development Centre
Phone: 01-6630588
Email: cdc@ntc.net.np
Website: www.moecdc.gov.np

Preface

School education is the foundation for preparing the citizen who are loyal to the nation and nationality, committed to the norms and values of federal democratic republic, self-reliant and respecting the social and cultural diversity. It is also remarkable for developing a good moral character with the practical know-how of the use of ICT along with the application of scientific concept and positive thinking. It is also expected to prepare the citizens who are moral and ethical, disciplined, social and human value sensitive with the consciousness about the environmental conversation and sustainable development. Moreover, it should be helpful for developing the skills for solving the real life problems. This textbook 'Mathematics, Grade 9' is fully aligned with the intent carried out by the National Curriculum Framework for School Education, 2076 and is developed fully in accordance with the new Secondary Level Mathematics Curriculum (Grade 9-10), 2078.

This textbook, initially written by Mr. Ganesh Sapkota, Mr. Narahari Acharya, Mr. Sakti Prasad Acharya, Mr. Jagannath Adhikari. It has been translated by a team of experts Mr. Loknath Bhattarai, Dr. Eakraj Pandit, Ms. Nirmala Gautam, Ms. Pramila Bakhati, Mr. Ram Chandra Dhakal and Mr. Jagannath Adhikari. The contribution made by Director General Baikuntha Prasad Aryal, Prof. Dr. Ramjee Prasad Pandit, Mr. Keshab Raj Phulara, Mr. Ram Hada and Ms. Nirmala Gautam is remarkable in bringing the book in this form. The language of this book was edited by Mr. Nabin Kumar Khadka. The layout was designed by Mr. Nawaraj Puri. The Curriculum Development Centre extends sincere gratitude to all of them.

The textbook is a primary resource for classroom teaching. Considerable efforts have been made to make the book helpful in achieving the expected competencies of the curriculum. Curriculum Development Centre always welcomes constructive feedback for further betterment of its publications.

2079 B.S.

**Curriculum Development Centre
Sanothimi, Bhaktapur**

Contents

Lesson	Topics	Page Number
1.	Sets	1 – 24
2.	Tax	25 – 49
3.	Commission and Dividend	50 – 59
4.	Household Arithmetic	60 – 87
5.	Area	88 – 130
6.	Prism	131 – 146
7.	Cylinder and Sphere	147 – 169
8.	Sequence and Series	170 – 183
9.	Factorization	184 – 196
10.	Highest Common Factor and Lowest Common Multiple	197 – 213
11.	Linear Equation	214– 235
12.	Indices	236 – 250
13.	Triangle	251 – 272
14.	Quadrilateral	273 – 282
15.	Construction	283 – 294
16.	Circle	295 – 303
17.	Classification and Presentation of Data	304 – 323
18.	Measures of Central Tendency	324 – 344
19.	Probability	345 – 361
20.	Trigonometry	362– 377

1.0 Review

This kind of information was obtained while discussing with 4 students of grade 9 about the crops planted in their fields:

- (a) Crops planted in Anjal's field = Paddy, Wheat, Millet, Mustard, Peas, Mustardy
- (b) Crops planted in Bimala's field = Wheat, Buckwheat, Mustard, Tomato, Brinjal, Barley, Potato, Beans
- (c) Crops planted in Pemba's field = Buckwheat, Barley, Potato, Beans, Maize
- (d) Crops planted in Rambilas's field = Wheat, Mustard, Paddy, Maize, Banana, Sugarcane, Cabbage

Find the answers of the following questions based on the above information:

- (i) Write each of the above information by listing method.
- (ii) What types of sets are 'Crops planted in Anjal's field' and 'Crops planted in Pemba's field'?
- (iii) What types of sets are 'Crops planted in Bimala's field' and 'Crops planted in Rambilas's field'?
- (iv) What types of sets are 'Crops planted in Bimala's field' and 'Crops planted in Enjal's field'?
- (v) Construct the following subsets from crops planted in Rambilas's field. What types of sets are formed? Write by listing method:
 - Set of grains
 - Set of fruits
 - Set of vegetables

Discuss the above questions in group and present the conclusion in the class.

1.1 Operation of sets

Activity 1

Work in pairs. Collect different colours of flowers by each pair and construct sets from those flowers based on their colours. For example:

Set of colours of flowers collected by Supriya (S) = {red, yellow, blue, pink }

Set of colours of flowers collected by Anjila (A) = {yellow, white, blue, purple, orange, red }

Construct the following sets based on the above sets:

- Set of colours of flowers collected by Supriya or Anjila or both of them,
- Set of flowers of common colours collected by Supriya and Anjila,
- Set of colours of flowers collected by Anjila only,
- Set of colours of flowers except the colours of flowers collected by Supriya.

What types of sets are constructed in this way?

1.1.1 Union of sets

In the above sets,

Set of colours of flowers collected by Supriya(S)

$$= \{ \text{red, yellow, blue, pink} \}$$

Set of colours of flowers collected by Anjila(A)

$$= \{ \text{yellow, white, blue, purple, orange, red} \}$$

Set of colours of flowers collected by both

$$= \{ \text{red, yellow, blue, pink, white, purple, orange} \}$$

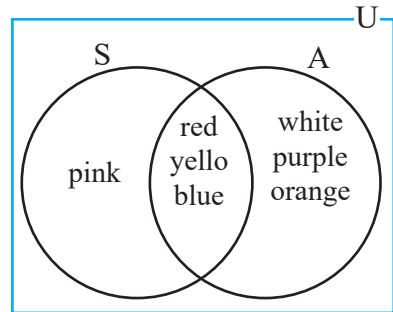

In this way, the set of colours of flowers collected by both of them is called the union of sets of colours of flowers collected by them separately.

If set A and B are the subsets of an universal set U, then the union of set A and B is denoted by $A \cup B$. $(A \cup B)$ consists of all the elements of the set A or the set B. According to the set builder method, it is written as $A \cup B = \{x: x \in A \text{ or } x \in B\}$. In the given Venn diagram, the shaded portion represents the set $(A \cup B)$.

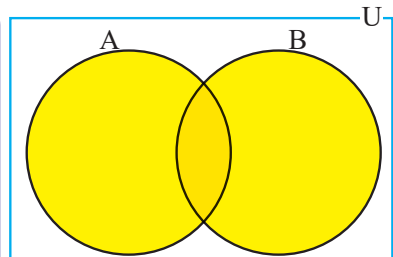

Similarly $(A \cup B \cup C)$ is written as $A \cup B \cup C = \{x: x \in A \text{ or } x \in B \text{ or } x \in C\}$. In the given Venn diagram the shaded portion represents the set $(A \cup B \cup C)$. While writing the elements in the union of sets we must write all the elements without repeating the common elements of those sets.

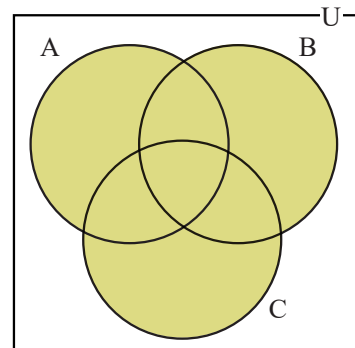

Example 1

If $P = \{\text{multiples of 3 less than 20}\}$ and $Q = \{\text{multiples of 2 less than 20}\}$, find $P \cup Q$ and present it in Venn diagram.

Solution

Here, $P = \{\text{multiples of 3 less than 20}\}$
 $= \{3, 6, 9, 12, 15, 18\}$

$Q = \{\text{multiples of 2 less than 20}\}$
 $= \{2, 4, 6, 8, 10, 12, 14, 16, 18\}$

Now, $P \cup Q$

$= \{3, 6, 9, 12, 15, 18\} \cup \{2, 4, 6, 8, 10, 12, 14, 16, 18\}$
 $= \{2, 3, 4, 6, 8, 9, 10, 12, 14, 15, 16, 18\}$

In the Venn diagram, shaded region represents $P \cup Q$.

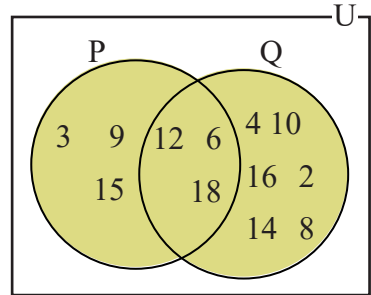

Example 2

If $A = \{\text{wheat, buckwheat, mustard, tomato, brinjal, chilly, barley, potato, beans}\}$ and $B = \{\text{buckwheat, barley, potato, beans}\}$ find, $A \cup B$ and also present in Venn diagram.

Solution

Here, $A = \{\text{wheat, buckwheat, mustard, tomato, brinjal, chilly, barley, potato, beans}\}$

$B = \{\text{buckwheat, barley, potato, beans}\}$

Now, $A \cup B$

$= \{\text{wheat, buckwheat, mustard, tomato, brinjal, chilly, barley, potato, beans}\} \cup \{\text{buckwheat, barley, potato, beans}\}$
 $= \{\text{wheat, buckwheat, mustard, tomato, brinjal, chilly, barley, potato, beans}\} = A$

In the adjoining Venn diagram, the shaded region represents the set $A \cup B$

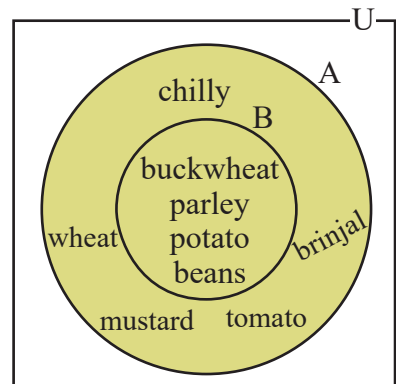

Activity 2

If two sets are disjoint, then in that condition, what will be their union? Discuss with each other and present by drawing Venn diagram.

Note: In two sets, if one is a subset of another then their union is the bigger one. If two sets are disjoint, then their union is formed by all the elements of both sets.

Example 3

If $P = \{\text{Even number less than 10}\}$ and $Q = \{\text{Odd number less than 10}\}$, find $P \cup Q$ and present it in Venn diagram.

Solution

Here, $P = \{\text{even number less than 10}\}$
 $= \{2, 4, 6, 8\}$

$Q = \{\text{odd number less than 10}\}$
 $= \{1, 3, 5, 7, 9\}$

$P \cup Q = \{2, 4, 6, 8\} \cup \{1, 3, 5, 7, 9\}$
 $= \{1, 2, 3, 4, 5, 6, 7, 8, 9\}$

In the Venn diagram, shaded region represents $P \cup Q$.

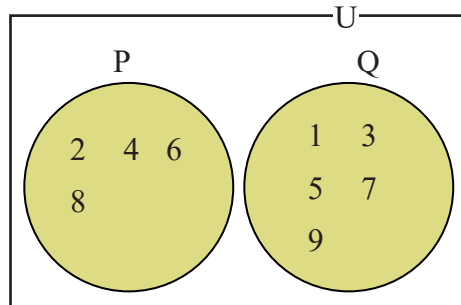

Example 4

If $A = \{a, b, c, d, e\}$, $B = \{a, e, i, o, u\}$, $C = \{d, e, f, g\}$ find $A \cup B \cup C$. Also present it in Venn diagram.

Solution

Here, $A = \{a, b, c, d, e\}$, $B = \{a, e, i, o, u\}$, $C = \{d, e, f, g\}$

Now, $(A \cup B \cup C)$

$= \{a, b, c, d, e\} \cup \{a, e, i, o, u\} \cup \{d, e, f, g\}$

$\therefore (A \cup B \cup C) = \{a, b, c, d, e, f, g, i, o, u\}$

In the adjoining Venn diagram, shaded region represents $(A \cup B \cup C)$.

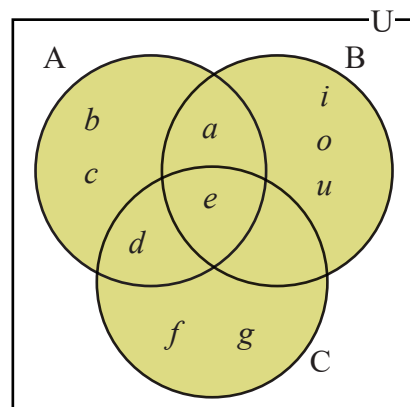

1.1.2 Intersection of sets

Among the students of grade 9 who like Science and Mathematics are as follows:

Set of students who like Science (S) = {Ram, Sita, Pemba, Tenjing, Dina, Binaya}

Set of students who like Mathematics (M) = {Hari, Sita, Manju, Dolma, Dina, Ajima}

Presenting the above sets in Venn diagram,

In the adjoining Venn diagram, the set of students who like both Science and Mathematics is {Sita, Dina}.

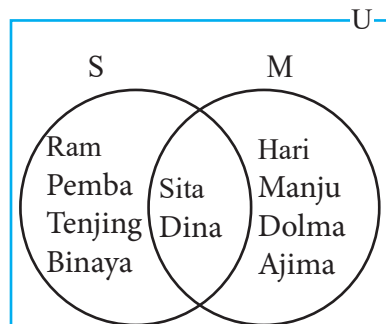

It is the intersection of the set of students who like Science and the set of students who like Mathematics.

If A and B be are two non-empty sets, then the set containing the common elements of the set A and the set B is called the intersection of A and B. It is denoted by $A \cap B$. According to the set builder method, $A \cap B$ is written as $A \cap B = \{x: x \in A \text{ and } x \in B\}$. In the adjoining Venn diagram, the shaded region represents the intersection of the set A and B.

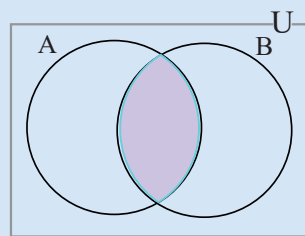

Example 5

If $P = \{\text{multiples of 3 less than 20}\}$ and $Q = \{\text{multiples of 2 less than 20}\}$, find $P \cap Q$ and present in Venn diagram.

Solution,

Here, $P = \{\text{multiples of 3 less than 20}\}$
 $= \{3, 6, 9, 12, 15, 18\}$

$Q = \{\text{multiples of 2 less than 20}\}$
 $= \{2, 4, 6, 8, 10, 12, 14, 16, 18\}$

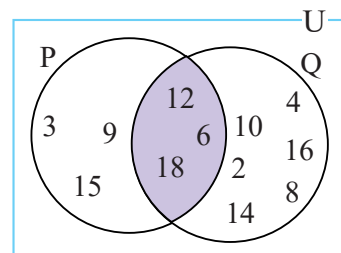

Now $P \cap Q$

$$= \{3, 6, 9, 12, 15, 18\} \cap \{2, 4, 6, 8, 10, 12, 14, 16, 18\}$$

$$= \{6, 12, 18\}$$

In the adjoining Venn diagram, the shaded region represents $P \cap Q$.

Example 6

If $A = \{\text{multiples of 2 less than 20}\}$ and $B = \{\text{multiples of 4 less than 20}\}$, find $A \cap B$ and present it in Venn diagram.

Solution,

Here, $A = \{\text{multiples of 2 less than 20}\}$
 $= \{2, 4, 6, 8, 10, 12, 14, 16, 18\}$

$B = \{\text{multiples of 4 less than 20}\} = \{4, 8, 12, 16\}$

Now $A \cap B = \{2, 4, 6, 8, 10, 12, 14, 16, 18\} \cap \{4, 8, 12, 16\}$
 $= \{4, 8, 12, 16\}$

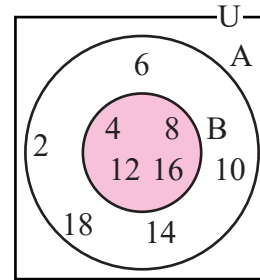

In the adjoining Venn diagram, shaded region represents $A \cap B$.

In two sets, if one is subset of another, then their intersection is the subset itself.

Activity 3

If two sets are disjoint what will be their intersection in that condition? Discuss in group and present in the class.

If two sets are disjoint then their intersection will be the empty set.

Example 7

If $M = \{a, e, i, o, u\}$ and $N = \{p, q, r, s, t\}$, find $M \cap N$ and present it in Venn diagram.

Solution,

Here, $M = \{a, e, i, o, u\}$, $N = \{p, q, r, s, t\}$

Now, $M \cap N = \{a, e, i, o, u\} \cap \{p, q, r, s, t\}$

$\therefore M \cap N = \{ \} \text{ or } \phi$

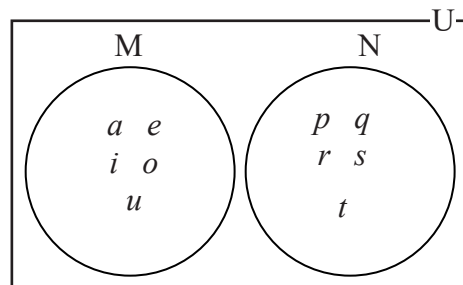

Shaded region is not in Venn diagram since there is no common element.

Example 8

If $P = \{1,2,3,4,5,6\}$, $Q = \{3,4,5,6,7,8\}$ and $R = \{1,3,5,7,9\}$, find $P \cap Q \cap R$ and show it in a Venn diagram.

Solution,

Here, $P = \{1, 2, 3, 4, 5, 6\}$

$Q = \{3, 4, 5, 6, 7, 8\}$

$R = \{1, 3, 5, 7, 9\}$

Now $P \cap Q \cap R$

$$= \{1, 2, 3, 4, 5, 6\} \cap \{3, 4, 5, 6, 7, 8\} \cap$$

$$\{1, 3, 5, 7, 9\}$$

$$= \{3, 5\}$$

$$\therefore P \cap Q \cap R = \{3, 5\}$$

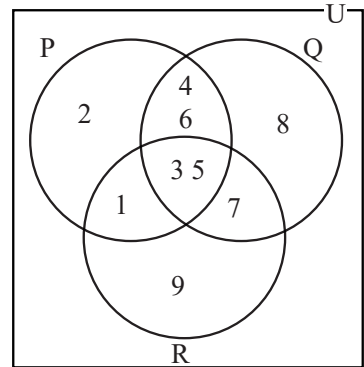

1.1.3 Difference of sets

Activity 4

Observe the given Venn diagram. Set of students who like to watch TV ($T = \{Sita, Chhiring, Kaji, Sonam, Dharmendra\}$), Set of students who like to read newspaper ($P = \{Ajima, Hari, Dipak, Sonam, Dharmendra\}$)

Write the set of students who like to watch TV only and who like to read newspaper only.

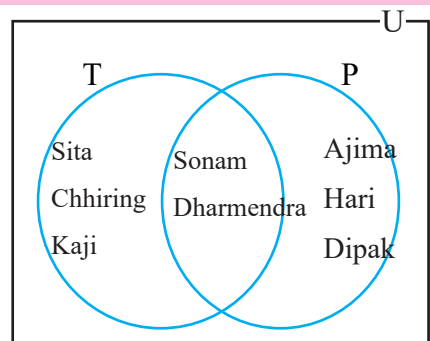

Here who like to read newspaper only do not like to watch TV. Thus it is called the difference of ‘set of students who like to read newspaper’ and ‘set of students who like to watch TV’.

Similarly, who like to watch TV only do not like to read newspaper. Thus, it is called the difference of the ‘set of students who like to watch TV’ and the ‘set of students who like to read newspaper’.

Set A and set B are the subsets of an universal set U. The set of elements which are in A but not in B is called the difference of A and B. It is written as $A - B$ and read as A difference B. Similarly, the set of elements which are in B only is called the difference of B and A. it is written as $B - A$ and read as B difference A. According to the set builder method it is written as $A - B = \{x: x \in A \text{ and } x \notin B\}$ and $B - A = \{x: x \in B \text{ and } x \notin A\}$

A – B and B – A in Venn diagram

(a) If A and B are overlapping sets,

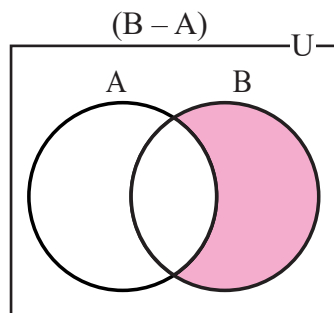
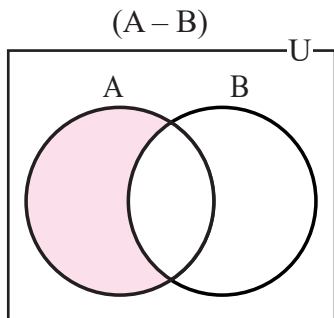

(b) If A and B are disjoint sets,

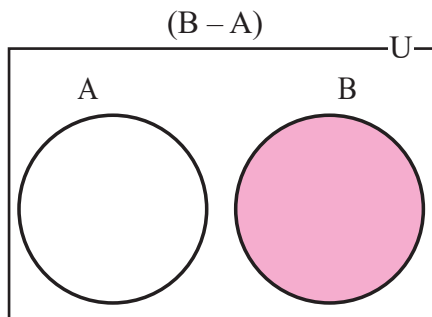
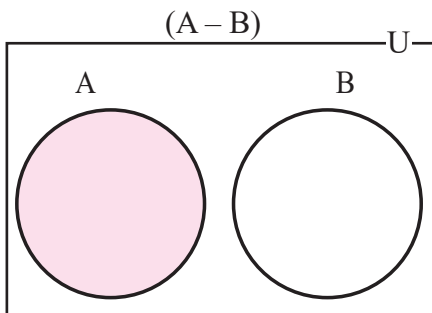

(c) If set B is the proper subset of set A,

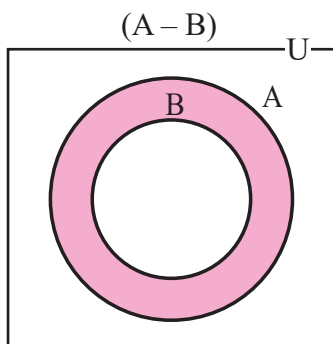

- If A and B are equal sets, then $A - B = B - A = \phi$
- Difference of set A and empty set $A - \phi = A$
- Difference of empty set and set A, $\phi - A = \phi$
- If set A is the proper subset of set B, then $A - B = \phi$

Note: Union of (A – B) and (B – A) is called the symmetric difference of A and B. It is denoted by $A \Delta B$ and written as $A \Delta B = (A - B) \cup (B - A)$.

Example 9

From the given Venn diagram, write the following sets by listing method:

Ma) A

b) B

c) $A - B$

d) $B - A$

Solution,

Here,

:a) $A = \{1, 3, 5, 7, 9\}$

:b) $B = \{6, 7, 8, 9, 10\}$

:c) $A - B = \{1, 3, 5\}$

:d) $B - A = \{6, 8, 10\}$

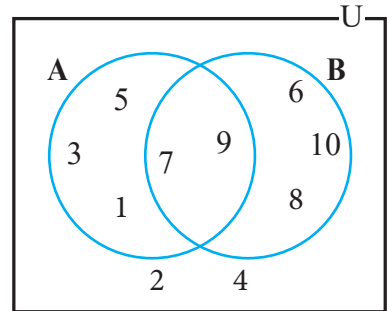

Example 10

If $U = \{1, 2, 3, 4, 5, 6, 7, 8, 9, 10\}$, $A = \{1, 2, 3, 4, 5\}$ and $B = \{4, 5, 6, 7, 8, 9, 10\}$ find $A - B$ and $B - A$. Also present them in separate Venn diagram by shading.

Solution,

Here, $A - B$

$$= \{1, 2, 3, 4, 5\} - \{4, 5, 6, 7, 8, 9, 10\}$$

$$= \{1, 2, 3\}$$

and

$B - A$

$$= \{4, 5, 6, 7, 8, 9, 10\} - \{1, 2, 3, 4, 5\}$$

$$= \{6, 7, 8, 9, 10\}$$

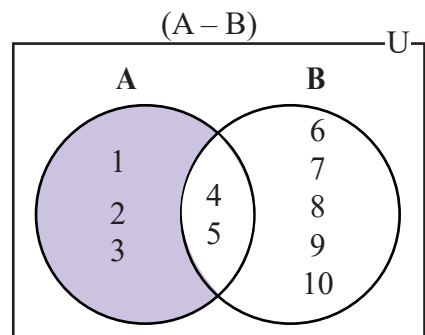

In the adjoining Venn diagram, $A - B$ and $B - A$ are shown by shading.

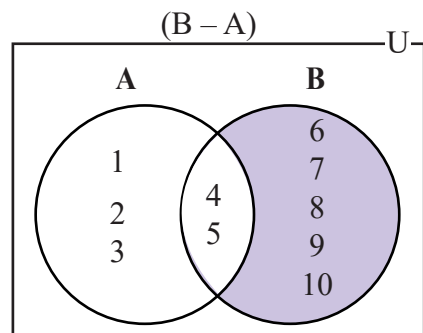

Example 11

If $U = \{x: x \leq 30, x \text{ is a natural number}\}$,

$A = \{x: x \text{ is a natural number greater than 15 and less than 30}\}$ and

$B = \{x: x \text{ is a natural number from 1 to 15}\}$, find $A - B$ and $B - A$.

Solution,

Here, $U = \{1, 2, 3, 4, \dots, 28, 29, 30\}$

$A = \{16, 17, 18, \dots, 27, 28, 29\}$ and

$B = \{1, 2, 3, 4, \dots, 13, 14, 15\}$

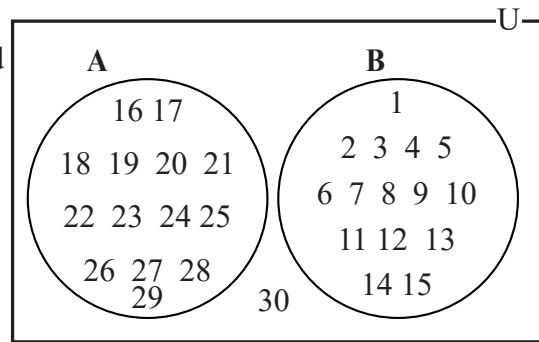

Hence,

$$A - B = \{16, 17, 18, \dots, 27, 28, 29\} - \{1, 2, 3, 4, \dots, 13, 14, 15\}$$

$$= \{16, 17, 18, \dots, 27, 28, 29\} = A \text{ and}$$

$$B - A = \{1, 2, 3, 4, \dots, 13, 14, 15\} - \{16, 17, 18, \dots, 27, 28, 29\}$$

$$= \{1, 2, 3, 4, \dots, 13, 14, 15\} = B$$

If A and B are disjoint sets then, $A - B = A$ and $B - A = B$.

1.1.4 Complement of a set

Let, A be a proper subset of an universal set U. Then the set of all elements of the set U, which do not belong to the set A is called the complement of the set A. It is denoted by A' or \bar{A} or A^c .

In other words, the difference between an universal set U and its subset A is called the complement of the set A. Symbolically it is written as $\bar{A} = U - A$.

It is written in set builder form as:

$$\bar{A} = \{x: x \in U \text{ but } x \notin A\}.$$

\bar{A} can be shown by shading in Venn diagram as in the adjoining figure.

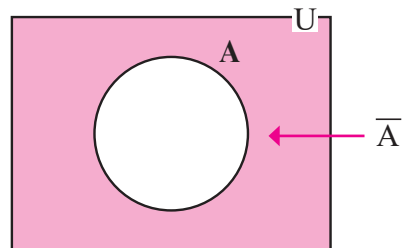

The union of A and \bar{A} is U . Thus, A and \bar{A} are said to be complement to each other. Also, $A \cup \bar{A} = U$ and $\bar{\bar{A}} = A$.

What will be $A \cap \bar{A}$? Discuss in group and write.

Example 12

If, $U = \{1, 2, 3, \dots, 18, 19, 20\}$, $A = \{1, 3, 5, 7, 9, 11, 13, 15, 17, 19\}$ and $B = \{2, 4, 6, 8, 10, 12, 14, 16, 18, 20\}$, then list the elements of the following sets:

- (a) \bar{A} (b) \bar{B} (c) $\bar{A} \cup \bar{B}$ (d) $\bar{A} \cap \bar{B}$

Solution,

Here, $U = \{1, 2, 3, \dots, 18, 19, 20\}$

$$A = \{1, 3, 5, 7, 9, 11, 13, 15, 17, 19\}$$

$$B = \{2, 4, 6, 8, 10, 12, 14, 16, 18, 20\}$$

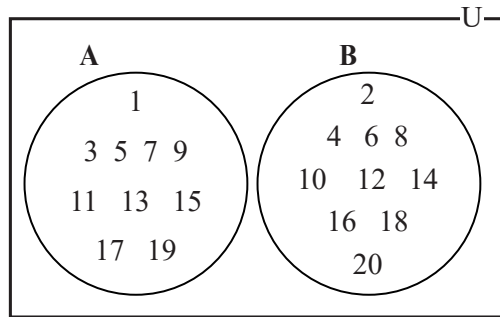

(a) $\bar{A} = U - A$

$$= \{1, 2, 3, \dots, 18, 19, 20\} - \{1, 3, 5, 7, 9, 11, 13, 15, 17, 19\}$$

$$= \{2, 4, 6, 8, 10, 12, 14, 16, 18, 20\}$$

(b) $\bar{B} = U - B$

$$= \{1, 2, 3, \dots, 18, 19, 20\} - \{2, 4, 6, 8, 10, 12, 14, 16, 18, 20\}$$

$$= \{1, 3, 5, 7, 9, 11, 13, 15, 17, 19\}$$

(c) $\bar{A} \cup \bar{B}$

$$= \{2, 4, 6, 8, 10, 12, 14, 16, 18, 20\} \cup \{1, 3, 5, 7, 9, 11, 13, 15, 17, 19\}$$

$$= \{1, 2, 3, 4, \dots, 18, 19, 20\}$$

(d) $\bar{A} \cap \bar{B}$

$$= \{2, 4, 6, 8, 10, 12, 14, 16, 18, 20\} \cap \{1, 3, 5, 7, 9, 11, 13, 15, 17, 19\}$$

$$= \{ \}$$

Example 13

If $U = \{1, 2, 3, 4, 5, 6, 7, 8, 9, 10\}$ and $A = \{1, 3, 5, 7, 9\}$, write the elements of the following sets by listing method:

- (a) \bar{A} (b) $A \cup \bar{A}$ (c) $A \cap \bar{A}$ (d) $\bar{\bar{A}}$

Solution,

Here, $U = \{1, 2, 3, 4, 5, 6, 7, 8, 9, 10\}$ and

$$A = \{1, 3, 5, 7, 9\}$$

- a) $\bar{A} = U - A$
 $= \{1, 2, 3, 4, 5, 6, 7, 8, 9, 10\} - \{1, 3, 5, 7, 9\}$
 $= \{2, 4, 6, 8, 10\}$
- b) $A \cup \bar{A} = \{1, 3, 5, 7, 9\} \cup \{2, 4, 6, 8, 10\}$
 $= \{1, 2, 3, 4, 5, 6, 7, 8, 9, 10\} = U$
- c) $A \cap \bar{A} = \{1, 3, 5, 7, 9\} \cap \{2, 4, 6, 8, 10\} = \phi$
- d) $\bar{\bar{A}} = U - \bar{A}$
 $= \{1, 2, 3, 4, 5, 6, 7, 8, 9, 10\} - \{2, 4, 6, 8, 10\}$
 $= \{1, 3, 5, 7, 9\} = A$

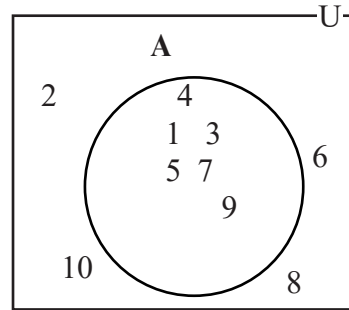

Example 14

If, $U = \{a, b, c, d, e, f, g, h, i, j, k\}$, $A = \{a, b, c, d, i, j\}$, $B = \{c, d, e, f, g, h, i\}$ and $C = \{d, e, f, g, h, i, j, k\}$, list out the elements of the following sets:

- (a) $\overline{(A \cup B) \cap C}$ (b) $\bar{A} \cup \bar{B}$ (c) $A \cap \bar{B}$
(d) $(A \cap \bar{C}) \cup \bar{A}$ (e) $(\bar{A} \cap C) \cup \bar{B}$

Solution,

- (a) $\overline{(A \cup B) \cap C}$
 $(A \cup B) = \{a, b, c, d, i, j\} \cup \{c, d, e, f, g, h, i\}$
 $= \{a, b, c, d, e, f, g, h, i, j\}$
 $(A \cup B) \cap C = \{a, b, c, d, e, f, g, h, i, j\} \cap \{d, e, f, g, h, i, j, k\}$
 $= \{d, e, f, g, h, i, j\}$

Again, $\overline{(A \cup B) \cap C}$

$$\begin{aligned}
&= U - \{(A \cup B) \cap C\} \\
&= \{a, b, c, d, e, f, g, h, i, j, k\} - \{d, e, f, g, h, i, j\} \\
&= \{a, b, c, k\}
\end{aligned}$$

(b) $\bar{A} \cup \bar{B}$

$$\begin{aligned}
\bar{A} &= U - A \\
&= \{a, b, c, d, e, f, g, h, i, j, k\} - \{a, b, c, d, i, j\} \\
&= \{e, f, g, h, k\} \\
\bar{B} &= U - B \\
&= \{a, b, c, d, e, f, g, h, i, j, k\} - \{c, d, e, f, g, h, i\} \\
&= \{a, b, j, k\}
\end{aligned}$$

Again, $\bar{A} \cup \bar{B}$

$$\begin{aligned}
&= \{e, f, g, h, k\} \cup \{a, b, j, k\} \\
&= \{a, b, e, f, g, h, j, k\}
\end{aligned}$$

(c) $A \cap \bar{B}$

$$\begin{aligned}
&= \{a, b, c, d, i, j\} \cap \{a, b, j, k\} \\
&= \{a, b, j\}
\end{aligned}$$

(d) $\bar{C} = U - C$

$$\begin{aligned}
&= \{a, b, c, d, e, f, g, h, i, j, k\} - \{d, e, f, g, h, i, j, k\} \\
&= \{a, b, c\}
\end{aligned}$$

Now, $A \cap \bar{C}$

$$\begin{aligned}
&= \{a, b, c, d, i, j\} \cap \{a, b, c\} \\
&= \{a, b, c\}
\end{aligned}$$

Again, $(A \cap \bar{C}) \cup \bar{A}$

$$\begin{aligned}
&= \{a, b, c\} \cup \{e, f, g, h, k\} \\
&= \{a, b, c, e, f, g, h, k\}
\end{aligned}$$

(e) $(\bar{A} \cap C)$

$$\begin{aligned}
&= \{e, f, g, h, k\} \cap \{d, e, f, g, h, i, j, k\} \\
&= \{e, f, g, h, k\}
\end{aligned}$$

$(\bar{A} \cap C) \cup \bar{B}$

$$\begin{aligned}
&= \{e, f, g, h, k\} \cup \{a, b, j, k\} \\
&= \{a, b, e, f, g, h, j, k\}
\end{aligned}$$

Exercise 1

1. In the given Venn diagram, F represents the set of students who like football and V represents the set of students who like volleyball. Write the elements of the following sets by listing method:

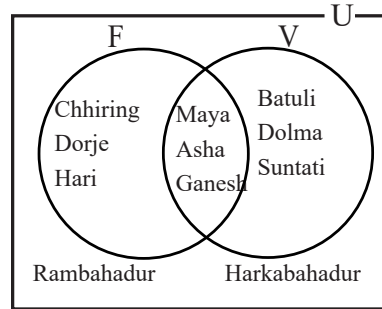

- (a) F (b) V (c) $F \cup V$
 (d) $F \cap V$ (e) U

2. If $U = \{a, b, c, d, e, f, g, h, i, j, k\}$, $A = \{a, c, e, f, g, i, k\}$ and $B = \{b, d, i, j, k, h\}$ find the following sets and also present in a separate Venn diagram:

- (a) $(A \cap B)$ (b) $(B \cup A)$ (c) $A - B$ (d) $B - A$

3. If, $U = \{x: x \text{ is a whole number from 1 to 30}\}$, $A = \{x: x \text{ is a multiple of 3 from 1 to 30}\}$, $B = \{x: x \text{ is a multiple of 4 from 1 to 30}\}$ and $C = \{x: x \text{ is a multiple of 5 from 1 to 30}\}$, write the following sets by listing method and present them in a Venn diagram:

- (a) $(A - B)$ (b) $(B - A)$ (c) $(A - C)$ (d) $(B - C)$
 (e) $(A \cup B)$ (f) $A \cup B \cup C$ (g) $A \cap B \cap C$ (h) $\overline{(B \cup C)}$

4. If $U = \{a, b, c, d, e, f, g, h, i, j, k\}$, $A = \{a, c, d, f\}$, $B = \{g, h, i\}$ then,

- (a) Construct the following sets:

- (i) \overline{A} (ii) \overline{B} (iii) $\overline{A \cup B}$
 (iv) $\overline{A \cap B}$ (v) $\overline{A \cup B}$ (vi) $\overline{(A \cap B)}$

- (b) Which of the sets in question A are equal? Find.

5. If $U = \{\text{set of actual numbers from 1 to 12}\}$, $E = \{\text{set of even numbers from 1 to 12}\}$, $O = \{\text{set of odd numbers from 1 to 12}\}$ and $P = \{\text{set of prime numbers from 1 to 12}\}$, find the following sets and also present them in Venn diagram:

- (a) \overline{E} (b) \overline{O} (c) \overline{P} (d) $\overline{(E \cup P)}$
 (e) $\overline{P \cap O}$ (f) $\overline{P - O}$ (g) P (h) $\overline{(E \cup O \cup P)}$
 (i) $\overline{(E \cap O \cap P)}$ (j) $\overline{(E \cup P)} - (P \cap O)$ (k) $\overline{P} \cup (E \cap O)$

6. If $U = \{m, n, o, p, q, r, s, t, u, v\}$, $A = \{q, r, s, t, u, v\}$, $B = \{n, o, p, q, r\}$ and $C = \{m, u, s, t, q, r\}$ find the sets of the following relations. Also present them by drawing separate Venn diagram:

- (a) $(A \cap B)$ (b) $(A \cup B) \cap C$ (c) $(A \cup B \cup C)$ (d) $(A \cap B \cap C)$
 (e) $(A - B)$ (f) $\overline{(A \cup B \cup C)}$ (g) $\overline{A \cap B}$ (h) \overline{A} (i) $(A \cap C) \cup B$

7. From the following Venn diagram, write the sets represented by the shaded region in set notation:

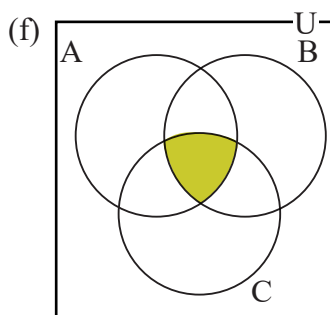
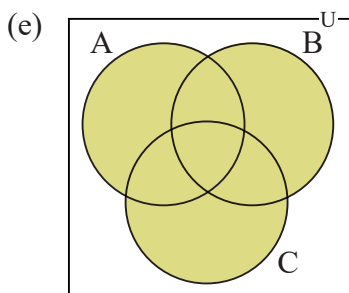
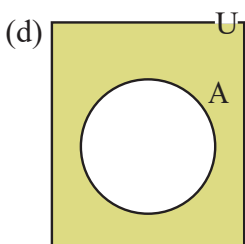
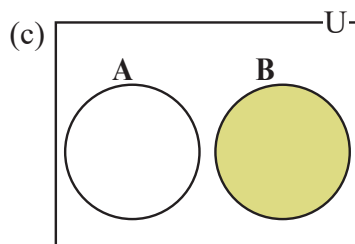
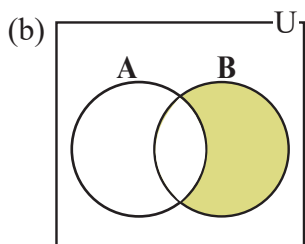
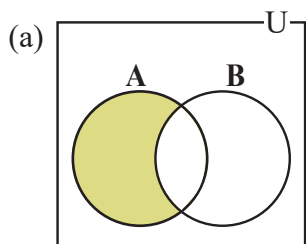

8. If P and Q are the intersecting subsets of an universal set U, show the following sets by drawing Venn diagram:

- (a) $P - Q$ (b) $Q - P$ (c) $(P - Q) \cup P$ (d) $P \cap (Q - P)$

9. Write an universal set U and two subsets X and Y. After that, write the elements of following sets by listing method:

- (a) $(\overline{X} \cup \overline{Y})$ (b) $(X \cap \overline{Y})$ (c) \overline{X} (d) $\overline{X} \cap \overline{Y}$

10. Construct the following sets from the students of your class:

- (a) set of all students
 (b) set of girls
 (c) set of boys

Which of the above set is universal set and which sets are the subsets of the universal set? Write with appropriate symbol. After that find the compliment of all those sets.

Answers

- (a) {Chhiring, Dorje, Hari, Maya, Aasha, Ganesh}

(b) {Batuli, Dolma, Suntali, Maya, Aasha, Ganesh}

(c) {Chhiring, Dorje, Hari, Batuli, Dolma, Suntali, Maya, Aasha, Ganesh}

(d) {Maya, Aasha, Ganesh}

(e) {Chhiring, Dorje, Hari, Batuli, Dolma, Suntali, Maya, Aasha, Ganesh, Rajbahadur, Harkabahadur}
- (a) $\{i, k\}$ (b) U (c) $\{a, c, e, f, g\}$ (d) $\{b, d, j, h\}$

(e) \emptyset and show the Venn diagrams to your teacher.
- (a) $\{3, 6, 9, 15, 18, 21, 27, 30\}$ (b) $\{4, 8, 16, 20, 28\}$

(c) $\{3, 6, 9, 12, 18, 21, 24, 27\}$ (d) $\{4, 8, 12, 16, 24, 28\}$

(e) $\{3, 4, 6, 8, 9, 12, 15, 16, 18, 20, 21, 24, 27, 28, 30\}$, and show Venn diagrams to your teacher.

(f) $\{3, 4, 5, 6, 8, 9, 10, 12, 15, 16, 18, 20, 21, 24, 25, 27, 28, 30\}$

(g) $\{ \}$

(h) $\{1, 2, 3, 4, 6, 7, 9, 11, 13, 14, 17, 18, 19, 21, 22, 23, 26, 27, 29\}$
- (a) i) $\{b, e, g, h, i, j, k\}$ (ii) $\{a, b, c, d, e, f, j, k\}$

iii) $\{a, b, c, d, e, f, g, h, i, j, k\}$ (iv) $\{b, e, j, k\}$

(v) $\{b, e, j, k\}$ (vi) U

(b) Show to your teacher.
- (a) $\{1, 3, 5, 7, 9, 11\}$ (b) $\{2, 4, 6, 8, 10, 12\}$

(c) $\{1, 4, 6, 8, 9, 10, 12\}$ (d) $\{1, 9\}$ (e) U (f) Q

(g) $\{2, 3, 5, 7, 11\}$ (h) $\{1, 2, 3, 4, 5, 6, 7, 8, 9, 10, 11, 12\}$

(i) $\{1, 2, 3, 4, 5, 6, 7, 8, 9, 10, 11, 12\}$ (j) $\{1, 9\}$ (k) $\{1, 4, 6, 8, 9, 10\}$
- (a) $\{q, r\}$ (b) $\{u, s, t, r\}$ (c) $\{m, n, o, p, q, r, s, t, u, v\}$

(d) $\{q, r\}$ (e) $\{s, t, u, v\}$ (f) $\{ \}$ (g) $\{m, n, o, p, s, t, u, v\}$

(h) $\{m, n, o, p\}$ (i) $\{q, r, s, t, u, n, o, p\}$
- (a) $(A - B)$ (b) $(B - A)$ (c) B or $B - A$

(d) $\bar{A} \cap U - A$ 8 - 10. Show to your teacher.

1.2 Cardinality of sets

The total number of elements of a set is called the cardinality of that set. For example, in a set $A = \{m, a, t, h\}$, the total number of element is 4. So, the cardinality of the set A is 4. Symbolically it is written as $n(A) = 4$.

Cardinality of an empty set is always zero. For example, $B = \{\text{set of students of grade 9 having age less than 5 years}\}$. In the set B , there is no element or the cardinality is zero. So it is written as $n(B) = 0$.

Activity 1

(a) If,

$U = \{\text{set of SAARC countries}\}$

$A = \{\text{Nepal, Bharat, Pakistan, Afghanistan}\}$

$B = \{\text{Bhutan, Bangladesh, Shreelanka, Maldives}\}$

what will be the value of $n(A \cup B)$

Here, there is no common element in set A and set

B . So, in these disjoint sets $n(A \cup B) = 8$.

Again, $n(A) = 4$, $n(B) = 4$, $n(A \cup B) = n(A) + n(B) = 4 + 4 = 8$.

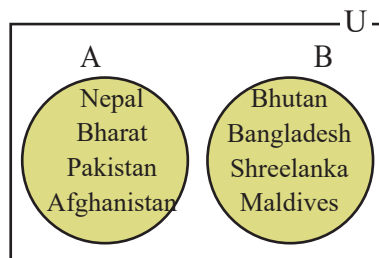

(b) If, $A = \{a, b, c, d, e\}$, $B = \{d, e, f, g\}$

$(A \cup B) = \{a, b, c, d, e, f, g\}$ and $(A \cap B) = \{d, e\}$

So, $n(A \cup B) = 7$ and $n(A \cap B) = 2$

\therefore If two sets A and B are intersecting sets, then

$n(A \cup B) = n(A) + n(B) - n(A \cap B)$.

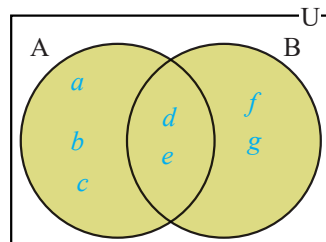

Activity 2

Observe the given Venn diagram. Find the cardinality of the following sets and present in class room.

a) $n(A)$

b) $n(B)$

c) $n(C)$

d) $n(A \cup B \cup C)$

e) $n(A \cap B \cap C)$

Here, from the Venn diagram,

$A = \{a, b, c, d, e\}$ $\therefore n(A) = 5$

$B = \{a, e, i, o, u\}$ $\therefore n(B) = 5$

$C = \{d, e, f, i\}$ $\therefore n(C) = 4$

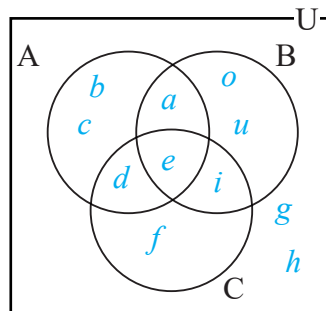

$$\begin{aligned} (A \cup B \cup C) &= \{a, b, c, d, e, f, i, o, u\} & \therefore n(A \cup B \cup C) = 9 \\ \overline{(A \cup B \cup C)} &= \{g, h\} & \therefore n(\overline{(A \cup B \cup C)}) = 2 \end{aligned}$$

Activity 3

If M and N are any two overlapping sets, then the number of elements of the set M only is denoted by $n_o(M)$ and N only is denoted by $n_o(N)$.

From the given Venn diagram, $n_o(M) = 3$

Thus, $n_o(M) = n_o(M - N)$ It can also be written as

$$n_o(M) = n(M) - n(M \cap N)$$

$$\text{Similarly, } n_o(N) = 4$$

$$\text{Similarly } n_o(N) = n(N - M) = n(N) - n(M \cap N)$$

$$\text{Here, } n(M) = 5, n(N) = 6, n_o(M) = 3, n_o(N) = 4,$$

$$n(M \cup N) = 9 / n(M \cap N) = 2 \times 5.$$

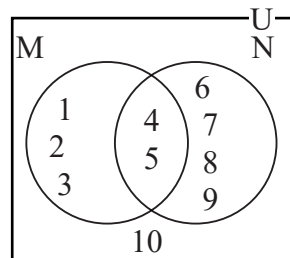

If a set is proper subset of another set, or if $A \subset B$, then $n(A \cup B) = n(B)$ and $n(A \cap B) = n(A)$.

Example 1

If, $A = \{1, 2, 3\}$ and $B = \{1, 2, 3, 4, 5\}$, prove the following:

$$(a) n(A \cup B) = n(B) \quad (b) n(A \cap B) = n(A)$$

Solution,

Here, $A = \{1, 2, 3\}$ and $B = \{1, 2, 3, 4, 5\}$

$$\begin{aligned} (a) \quad n(A \cup B) &= \{1, 2, 3\} \cup \{1, 2, 3, 4, 5\} \\ &= \{1, 2, 3, 4, 5\} \end{aligned}$$

$$\therefore n(A \cup B) = 5$$

$$\therefore n(A \cup B) = n(B)$$

$$\begin{aligned} (b) \quad n(A \cap B) &= \{1, 2, 3\} \cap \{1, 2, 3, 4, 5\} \\ &= \{1, 2, 3\} \end{aligned}$$

$$\therefore n(A \cap B) = 3$$

$$n(A) = \{1, 2, 3\}$$

$$\therefore n(A \cap B) = n(A)$$

Method of finding cardinality of set:

Observe the following Venn diagram and answer the questions given below:

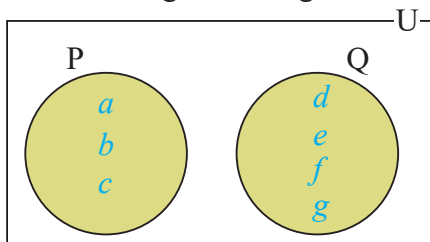

Fig. 1

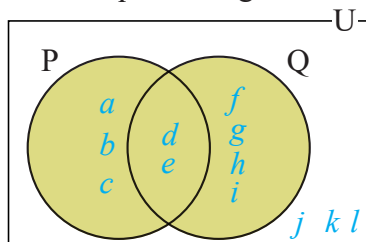

Fig. 2

a) $n(U) = ?$ b) $n(P) = ?$ c) $n(Q) = ?$

d) $n(P \cup Q) = ?$

e) $n(P \cap Q) = ?$ f) $n(\overline{P \cup Q}) = ?$

Here in the fig.1, P and Q are disjoint sets.

$$U = \{a, b, c, d, e, f, g\}$$

$$n(U) = 7$$

$$P = \{a, b, c\}$$

$$n(P) = 3$$

$$Q = \{d, e, f, g\}$$

$$n(Q) = 4$$

$$(P \cup Q) = \{a, b, c, d, e, f, g\}$$

$$n(P \cup Q) = 7$$

$$(P \cap Q) = \{ \}$$

$$n(P \cap Q) = 0$$

$$(\overline{P \cup Q}) = \{ \}$$

$$n(\overline{P \cup Q}) = 0$$

$$\therefore n(U) = n(P \cup Q)$$

Here, in the fig.2 P and Q are overlapping sets.

$$U = \{a, b, c, d, e, f, g, h, i, j, k, l\}$$

$$n(U) = 12$$

$$P = \{a, b, c, d, e\}$$

$$n(P) = 5$$

$$Q = \{d, e, f, g, h, i\}$$

$$n(Q) = 6$$

$$(P \cup Q) = \{a, b, c, d, e, f, g, h, i\}$$

$$n(P \cup Q) = 9$$

$$(P \cap Q) = \{d, e\}$$

$$n(P \cap Q) = 2$$

$$(\overline{P \cup Q}) = \{j, k, l\}$$

$$n(\overline{P \cup Q}) = 3$$

$$\therefore n(U) = n(P \cup Q) + n(\overline{P \cup Q})$$

Cardinality of sets can be written in the following formulae:

(a) If A and B are any two disjoint sets, then, $n(A \cup B) = n(A) + n(B)$

(b) If A and B are any two overlapping sets, then $n(A \cup B) = n(A) + n(B) - n(A \cap B)$ Or, $n(A \cup B) = n_o(A) + n_o(B) + n(A \cap B)$

(c) If U contains only the elements of set A and B, then $n(U) = n(A \cup B)$.

(d) If U contains some more elements other than the elements of set A and set B, then $n(\overline{A \cup B}) = n(U) - n(A \cup B)$.

Similarly, $n(U) = n(A \cup B) + n(\overline{A \cup B})$.

(e) In overlapping sets A and B, $n_o(A) = n(A) - n(A \cap B)$ and $n_o(B) = n(B) - n(A \cap B)$

Example 2

Observe the adjoining Venn diagram and answer the questions given below:

- (a) $n(A)$ (b) $n(B)$ (c) $n(C)$
 (d) $n(A \cap B)$ (e) $n(A \cap B \cap C)$
 (f) $n(A \cup B \cup C)$ (f) $n(\overline{A \cup B \cup C})$
 (h) $n_o(A)$ (i) $n_o(A \cap B)$ (j) $n(A - B)$

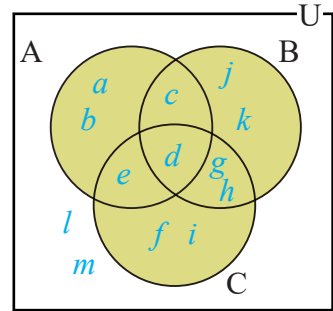

Solution,

From the given Venn diagram,

- (a) $A = \{a, b, c, d, e\}$
 $\therefore n(A) = 5$
- (b) $B = \{c, d, g, h, j, k\}$
 $\therefore n(B) = 6$
- (c) $C = \{e, d, f, g, h, i\}$
 $\therefore n(C) = 6$
- (d) $A \cap B = \{c, d\}$
 $\therefore n(A \cap B) = 2$
- (e) $A \cap B \cap C = \{d\}$
 $\therefore n(A \cap B \cap C) = 1$
- (f) $(A \cup B \cup C) = \{a, b, c, d, e, f, g, h, i, j, k\}$
 $\therefore n(A \cup B \cup C) = 11$
- (g) $\overline{(A \cup B \cup C)} = \{l, m\}$
 $\therefore n(\overline{A \cup B \cup C}) = 2$
- (h) $A = \{a, b\}$
 $\therefore n_o(A) = 2$
- (i) $A \cap B = \{c\}$
 $\therefore n_o(A \cap B) = 1$
- (j) $A - B = \{a, b, e\}$
 $\therefore n(A - B) = 3$

Exercise 1.2

1.(a) Observe the given Venn diagram and find the cardinality of the following sets:

- (a) $n(S)$ (b) $n(T)$ (c) $n(U)$
 (d) $n(S \cap T)$ (e) $n(R \cup T)$ (f) $n(S \cap R \cap T)$
 (g) $n(S \cup R \cup T)$ (h) $n(\overline{S \cup R \cup T})$
 (i) $n_o(S)$ (j) $n_o(S \cap R)$ (k) $n(\overline{R})$

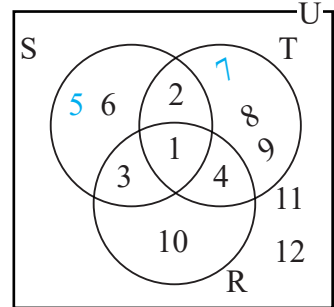

- (b) If, A and B are any two disjoint sets, $n(A) = 30$, $n(B) = 35$, find the value of $n(A \cup B)$.

2.(a) From the given Venn diagram, find the cardinality of the following sets:

- (a) $n(A)$ (b) $n(B)$ (c) $n(A \cup B)$
 (d) $n(A \cap B)$ (e) $n_o(A)$ (f) $n_o(B)$

- (b) If, $U = \{a, b, c, d, e, f, g\}$, $A = \{c, d, e, f\}$, $B = \{a, b, e, f\}$ and $C = \{d, e, f, g\}$, find the cardinality of the following sets:

- (a) $n(A - B)$ (b) $n(B - C)$
 (c) $n(\frac{A-C}{A \cup B})$ (d) $n(\overline{A})$
 (e) $n(\overline{A \cup B})$ (f) $n\{(A \cup B) - (A \cap B)\}$
 (g) $n\{(A - B) \cup (B - A)\}$

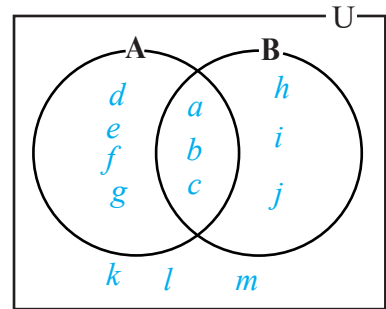

3.(a) If, $U = \{\text{set of natural numbers less than 20}\}$, $A = \{\text{set of even numbers less than 20}\}$, $B = \{\text{set of prime numbers less than 20}\}$ and $C = \{\text{set of square numbers less than 20}\}$, find the cardinality of the following sets:

- (a) $n(U)$ (b) $n(C)$ (c) $n(A \cap B)$ (d) $n(B - C)$
 (e) $n(\overline{A})$ (f) $n(A \cup C)$ (g) $n(\overline{A \cap B})$

- (b) If, $U = \{x: x \text{ is a natural number less than 20}\}$

$A = \{y: y \text{ is a prime number}\}$, $B = \{z: z \text{ is a factor of 18}\}$ and

$C = \{p: p \text{ is a multiple of 3 less than 20}\}$. Present the following sets by drawing separate Venn diagrams and find their cardinality:

- (a) $n(A \cup B)$ (b) $n(B \cup C)$ (c) $n(A \cup B \cup C)$
 (d) $n(A \cap B \cap C)$ (e) $n_o(A)$ (f) $n_o(A - B)$

$(g) n(\overline{A \cap B})$

$(h) n(\overline{C})$

4. From the given Venn diagram, find the cardinality of the following sets:

$(a) n(P \cup Q)$

$(b) n(P \cap Q)$

$(c) n(P \cup Q)$

$(d) n(\overline{P \cap Q})$

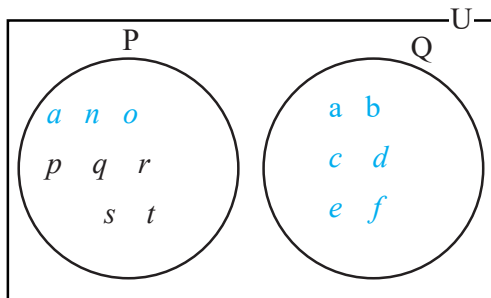

5. Find the cardinality of the following sets using the given Venn diagram.

$(a) n(S)$

$(b) n(T)$

$(c) n(S \cap T)$

$(d) n(S \cup T)$

$(e) n_o(T)$

$(f) n_o(S)$

$(g) n(\overline{T})$

$(h) n(\overline{S \cup T})$

$(i) n(\overline{S \cap T})$

$(j) n(U)$

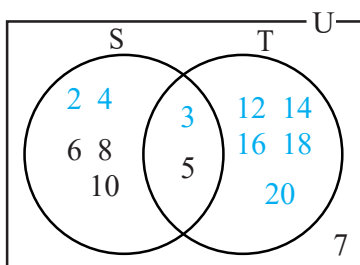

6. Observe the given Venn diagram and find the cardinality of the following sets:

$(a) n(A)$

$(b) n(B)$

$(c) n(C)$

$(d) n(A \cup B)$

$(e) n(A \cup B \cup C)$

$(f) n(A \cap B \cap C)$

$(g) n(\overline{A \cup B \cup C})$

$(h) n_o(A)$

$(i) n_o(C)$

$(j) n(U)$

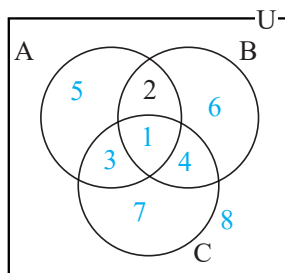

7. Verify the following relation from the adjoining Venn diagram:

- (a) $n(\overline{A}) = n(U - A)$
- (b) $n(A \cup B) = n(A) + n(B) - n(A \cap B)$
- (c) $n_o(A) = n(A - B)$
- (d) $n(A \cup B) = n_o(A) + n(B)$
- (e) $n(A \cup C) = n_o(A) + n(C)$
- (f) $n(B \cup C) = n_o(B) + n(C)$
- (g) $\overline{(A \cup B \cup C)} = U - (A \cup B \cup C)$

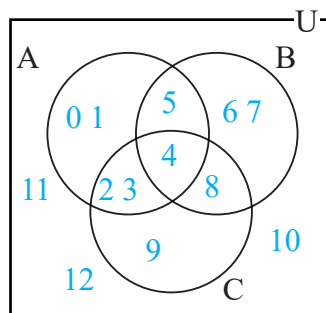

Project Work

- Ask at least 20 people which of the fruit either apples or orange they like. Denote the set of people who like apple by A and the set of people who like orange by O. According to their responses, write the set of people who like apple, who like orange, who like both fruits, who like apple only, who like orange only, who don't like apple and orange by listing method. From the obtained information construct the following sets. Also present them in a separate Venn diagram:

- (a) A (b) O (c) $A \cup O$ (d) \overline{A}
- (e) $A - O$ (f) $O - A$ (g) $(O - A) \cup (A - O)$

- Ask all the students in your class which of football, cricket and basketball they like to play. Denote the set of students who like to play football by F, cricket by C and basketball by B. According to their responses, find the set of students who like to play football, who like to play cricket, who like to play basketball, who like to play any two sports, who like to play all three sports, who like to play only one sport and who do not like to play any of them by listing method. Find the cardinality of the following sets and also present them by drawing separate Venn diagram:

- (a) $n(F)$ (b) $n(C)$ (c) $n(B)$ (d) $n(F \cap B)$
- (e) $n(B \cap C)$ (f) $n(F \cap C \cap B)$ (g) $n(F \cup C \cup B)$ (h) $n(\overline{F \cup B})$
- (i) $n(\overline{B \cup C})$ (j) $n(\overline{C})$ (k) $n_o(F)$ (l) $n_o(F \cap C)$
- (m) $n(F - B)$

Answers

- (a) (i) 5 (ii) 6 (iii) 12 (iv) 2 (v) 8 (vi) 1
(vii) 10 (ix) 2 (x) 2 (xi) 1 (xii) 8 (xiii) 65
- (a) (i) 6 (ii) 5 (iii) 9 (iv) 2 (v) 4 (vi) 3
(b) (i) 2 (ii) 2 (iii) 1 (iv) 3 (v) 1 (vi) 4 (vii) 4
- (a) (i) 19 (ii) 4 (iii) 1 (iv) 8 (v) 10 (vi) 12 (vii) 18
(b) (i) 12 (ii) 8 (iii) 14 (iv) 1 (v) 6 (vi) 6 (vii) 12 (viii) 8
- (a) 14 (b) $\{ \}$ or ϕ (c) $\{ \}$ or ϕ (d) 14
- (a) 7 (b) 7 (c) 2 (d) 12 (e) 12 (f) 5
(g) 5 (h) 6 (i) 1 (j) 11 (k) 13
- (a) 4 (b) 4 (c) 4 (d) 6 (e) 7 (f) 1
(g) 1 (h) 1 (i) 1 (j) 8
- Show to your teacher.

2.0 Review

Divide the students into appropriate number of groups and discuss the conditions given below.

- Bishal received his monthly, salary after deducting 1%.
- When Kamala bought a mobile, she paid by adding 13 % in the price of mobile.
- A headteacher received Rs. 510 out of Rs. 600 as an allowance per meeting of a program.
- Shakti paid Rs. 300 to renew the bluebook of his motorcycle, registered at transportation Management Service Office, Bagmati province for the fiscal year 2078/2079.

In the above cases, the amounts added and deducted are the tax amount. Different tax rates different headings are mentioned in the law unde.

2.1 Tax

Activity 1

Discuss among your friends the following questions based on the tax provisions included in the budget statement presented at the beginning of each fiscal year in our country.

- How does the government manage the administrative expenses and the development expenses of the state?
- How does the government manage the salary allowance given to the civil servants?
- You may have heard that the budget for the construction and maintenance of drinking water tanks, upgrading and development works such as skilled-based program etc. is being disbursed. Where do such expenses come from?

Tax is a compulsory payment that a person, firm or company has to pay to the government according to law. Tax is a main source of income of the state. The government conducts regular contingency and development Activity of the country according to the income received through this tax. So we all have to pay taxes. Paying tax is fulfilling the duty of a good citizen. Among the taxes that are in vogue in Nepal are vehicle tax, the customs tax, house-rent tax, income tax, value added tax, property tax, social security tax etc. Tax is expressed in percentage (%). For example, students going to study aboard has to pay 1 % tax on exchange money when they take money exchange facility.

2.1.1 Income tax

Activity 2

Discuss in a group with your peers regarding the income tax ceiling and questions given below. Then, present the findings in the class:

*Income tax rate applicable
to natural persons for the fiscal year 2078/2079*

Tax Rate only for Employment Income			
For Single Person		For Couple	
Title	Tax Rate	Title	Tax Rate
Income up to 4 Lakh rupees	1%	Income up to 4 Lakh and 50 Thousand rupees	1%
Income above Rs.400000 up to Rs.500000	10%	Income above Rs.450000 up to Rs.550000	10%
Income above Rs.500000 up to Rs.700000	20%	Income above Rs.550000 up to Rs.750000	20%
Income above Rs.700000 up to Rs.2000000	30%	Income above Rs.750000 up to Rs.2000000	30%
Income above Rs.2000000	36%	Income above Rs.2000000	36%

Tax Rate only for Business Income as an Individual Firm			
For Single Person		For Couple	
Title	Tax Rate	Title	Tax Rate
Income up to 4 Lakh rupees	Tax Free	Income up to 4 Lakh and 50 Thousand rupees	Tax Free
Income above Rs.400000 up to Rs.500000	10%	Income above Rs.450000 up to Rs.550000	10%
Income above Rs.500000 up to Rs.700000	20%	Income above Rs.550000 up to Rs. 750000	20%
Income above Rs.700000 up to Rs.2000000	30%	Income above Rs.750000 up to Rs.2000000	30%
Income above Rs.2000000	36%	Income above Rs.2000000	36%

(a) What is income tax?

- (b) Why does the government collect certain percent tax on our income amount by making laws?
- (c) Which agency manages the income tax in Nepal?
- (d) From where it can be studied easily about the income tax rate and ceiling fixed by Inland Revenue Department? What types of rules are mentioned?

The tax on the income of an individual or the group of people (industry, company etc.) is called income tax. Mainly, the tax on the income, salary and profit is the income tax. Income tax is one of the sources of income of the government. Income tax is calculated in percentage. There are different types of individual tax rate based on profession, occupation and marital status. According to the Income Tax Act 2058, four headings of income are (a) Employment (b) Business (c) Investment and (d) Contingent benefits. The responsibility of managing tax in Nepal in Nepal is given to Inland Revenue Department. The Inland Revenue Department prepares the income tax calculation procedure every year, details of which can be seen on the website <http://www.ird.gov.np>.

Income Tax Exemptions		
	Title	Ceiling
(a)	On the amount deposited at employees provident fund	On the less amount in one third of taxable income and Rs. 300000
(b)	On the amount deposited at citizen investment trust	
(c)	On the premium expenses paid as life insurance	Up to Rs. 25000 (with couple)
(d)	On the expenses on religious work and on donated amount	On the less amount in 5% of adjusted taxable income and Rs. 1,00,000.
(e)	On the obtained amount as remote allowance (based on remote area)	(a) Rs. 50,000 (b) Rs. 4,00,000 (c) Rs. 20,000 (d) Rs. 10,000
(f)	On the amount on 75% of foreign allowance	For staff working in Nepal's diplomatic mission aboard
(g)	On the expenses of medical treatment	25% of 15% of total expenses
(h)	Discount facility available to persons with disabilities	An additional 50 % of specified ceiling
(i)	On the premium paid for health insurance	Up to Rs. 20,000 yearly

(j)	On the amount contributed for social security fund	Up to Rs. 5,00,000 yearly
(k)	In case of woman who has only employment income	10% discount on income tax
(l)	In all allowance given as social security	
(m)	In the amount received through dowry, scholarship in-law's will	
(n)	In premium amount paid for insurance of private building owned by self	Up to Rs. 5000 yearly
(o)	In income as pension	An additional of 25% in specified ceiling
(p)	In case of taxpayer of firm registered individually	1 % tax is not imposed for pension income of a natural person who has contributed to employment fund and contribution based social security fund.

Example 1

The monthly salary of a married teacher is Rs. 37,990. How much income tax should be paid annually, when calculating the income of 13 months including festival expenses, received by the teacher according to the income tax rate of the fiscal year 2078/ 2079?

Solution,

Here, monthly salary = Rs. 37,990

Yearly income = $13 \times 37,990$
= Rs. 49,3870

Now writing the taxable income Rs. 4,93,870 according to the income tax ceiling,

Rs. 4,93,870 = Rs. 4,50,000 + Rs. 43,870

\downarrow \downarrow
 1% 10%

Annual income tax = 1% of Rs. 4,50,000 + 10% of Rs. 43,870

$$= \frac{1}{100} \times 4,50,000 + \frac{10}{100} \times 43,870$$

$$= 4,500 + 4,387$$

$$= \text{Rs. } 8,887$$

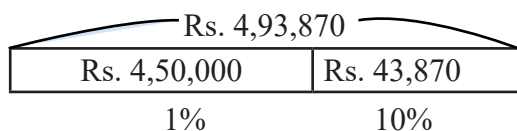

Example 2

The monthly salary of an unmarried woman staff working in a bank is Rs. 30,000. 1% social security tax is levied on income up to Rs. 4,00,000 and 10% on income above Rs. 4,00,000 per annum. If she receives a salary equal to 15 months in a year, how much tax should be paid annually?

Solution,

Here, monthly income of staff = Rs. 30,000

$$\begin{aligned}\text{Annual income} &= 15 \times \text{Rs. } 30,000 \\ &= \text{Rs. } 4,50,000\end{aligned}$$

Now writing the taxable income Rs. 4,50,000 according to the income tax ceiling,

$$\text{Rs. } 4,50,000 = \text{Rs. } 4,00,000 + \text{Rs. } 50,000$$

$$\begin{aligned}\therefore \text{Annual income tax} &= \underset{\substack{\downarrow \\ 1\%}}{1\%} \text{ of Rs. } 4,00,000 + \underset{\substack{\downarrow \\ 10\%}}{10\%} \text{ of Rs. } 50,000 \\ &= \frac{1}{100} \times 4,00,000 + \frac{10}{100} \times 50,000 \\ &= 4,000 + 5,000 \\ &= \text{Rs. } 9,000\end{aligned}$$

Being a woman will get 10% discount in income tax,

$$\begin{aligned}\text{Discount amount} &= 10\% \text{ of Rs. } 9,000 \\ &= \text{Rs. } 900\end{aligned}$$

$$\begin{aligned}\therefore \text{Annual tax payable the staff} &= \text{Rs. } 9,000 - \text{Rs. } 900 \\ &= \text{Rs. } 8,100\end{aligned}$$

Example 3

A married male employee in Nepal earning Rs. 40,500 monthly including Dearness Allowance of Rs. 2,000 pays Rs. 23,500 yearly as a premium for life insurance. He receives the salary of 13 months in a year including Festival Allowance of 1 month. If he deposits 10% of his income excluding dearness allowance and festival allowance to Employees Provident Fund, then how much income tax should he pay on the remaining income? Find out.

Solution,

Here monthly salary = Rs. 40,500 – Rs. 2,000 = Rs. 38,500

Annual salary = Rs. 38,500 × 12 = Rs. 4,62,000

Dearness Allowance = 2,000 × 12 = Rs. 24,000

Festival allowance = Rs. 38,500

Employees Provident Fund = $4,62,000 \times \frac{10}{100}$ = Rs. 46,200

Determinable Income = Rs. 4,62,000 + Rs. 24,000 + Rs. 38,500 + Rs. 46,200
= Rs. 5,70,700

Deducting,

(i) Amount deposited at Employees Provident Fund

Rs. 46,200 + Rs. 46,200 = Rs. 92,400

(ii) Premium for life insurance = Rs. 23,500

Total = Rs. 1,15,900

Now one third of determinable income = $Rs. 5,70,700 \times \frac{1}{3}$
= Rs. 1,90,233.33

Being the total amount deposited at Employees Provident Fund and premium of insurance is less than one third of determinable income,

Tax free income = Rs. 1,15,900

Taxable income = 5,70,700 – 1,15,900 = Rs. 4,54,800

Being a married male staff,

Payable income tax = 1% of Rs. 4,50,000 + 10% of Rs. 4,800

= $Rs. 4,50,000 \times \frac{1}{100} + 4,800 \times \frac{10}{100}$

= 4,500 + 480

= Rs. 4,980

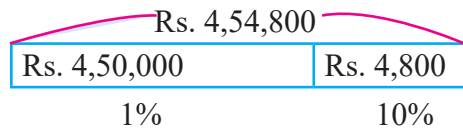

∴ The employee has to pay income tax of Rs. 4,980 annually.

Example 4

If a businessman is exempted from income tax up to Rs. 4,50,000 out of his annual income, the income tax is levied at the rate of 10% from Rs. 4,50,001 to Rs.5,50,000 and at the rate of 20% from Rs.5,50,001 to Rs.7,00,000, how much income tax should the businessman earning Rs. 6,75,000 annually have to pay?

Solution,

Here, expressing the total yearly income of Rs. 6,75,000 according to the given income tax ceiling,

$$\text{Rs. } 6,75,000 = \text{Rs. } 4,50,000 + \text{Rs. } 1,00,000 + \text{Rs. } 1,25,000$$

$$\begin{array}{ccc} \downarrow & \downarrow & \downarrow \\ \text{Tax free} & 10\% & 20\% \end{array}$$

∴ Total yearly income tax = 10 % of Rs. 1,00,000 + 20% of Rs. 1,25,000

$$= \text{Rs. } 1,00,000 \times \frac{10}{100} + 1,25,000 \times \frac{20}{100}$$

$$= \text{Rs. } 10,000 + 25,000$$

$$= \text{Rs. } 35,000$$

From Model drawing method,

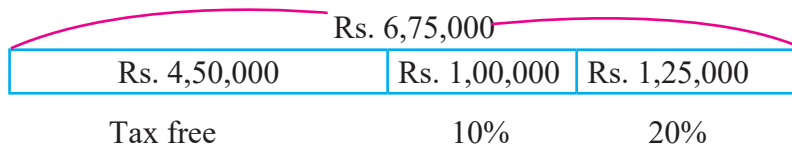

Total yearly income tax = 10 % of Rs. 1,00,000 + 20% of Rs. 1,25,000

$$= 1,00,000 \times \frac{10}{100} + 1,25,000 \times \frac{20}{100}$$

$$= 10,000 + 25,000$$

$$= \text{Rs. } 35,000$$

∴ That businessman has to pay yearly income tax of Rs. 35,000.

Example 5

Dhanabhadur has deposited Rs. 35,000 in a fixed saving account of a co-operative at the rate of 10% per annum simple interest for 4 years. If 5 % income tax is levied on interest earning from that saving, how much interest does he receive after deducting the tax? Find out.

Solution,

Here give,

Principal (P) = Rs. 35,000

Time (T) = 4 years

Rate of simple interest (R) = 10%

Tax rate = 5%

Simple Interest =?

Interest after deducting tax =?

Tax on income as interest =?

Using formula,

$$\begin{aligned} I &= \frac{P \times T \times R}{100} \\ &= \frac{35,000 \times 4 \times 10}{100} \\ &= \text{Rs. } 14,000 \end{aligned}$$

∴ Simple Interest = Rs. 14,000,

Here, the interest so obtained is calculated as Dhanabhadur's income from investment.

Again Income tax = 5 % of Rs. 14,000

$$\begin{aligned} &= \text{Rs. } 14,000 \times \frac{5}{100} \\ &= \text{Rs. } 700 \end{aligned}$$

∴ Tax on income as interest = Rs. 700

∴ Interest after deducting tax = Rs. 14,000 – Rs. 700
= Rs. 13,300

That co-operative deducts 5% tax from obtained interest and provides only Rs. 13,300 to the saver Dhanabhadur.

Exercise 2.1

1. In Nepal, an officer level married civil servant earning Rs. 38,000 monthly pays Rs. 23,500 yearly as a premium of life insurance. If his / her income is calculated as a salary equal to 13 months in a year including festival allowance, how much income tax do they have to pay yearly. Find out. (Calculate according to the income tax ceiling mentioned on the previous page.)
2. An employee working in an organization has to pay income tax at the rate of 1% up to Rs. 4,50,000 out of his income, above Rs. 4,50,000 up to Rs. 5,50,000 at the rate of 10 %, above Rs.5,50,000 up to Rs. 7,50,000 at the rate of 20 % and above Rs. 7,50,000 up to Rs.20,00,000 at the rate of 30%, how much income tax should be paid to the government by the employee earning Rs. 65,000 per month?
3. **Study the following table showing the income tax threshold for entrepreneurs doing business as a sole proprietorship:**

Yearly Income (Rs.)	Rate of Tax
1 - 4,50,000	Tax free
4,50,001 - 5,50,000	10%
5,50,001 - 7,50,000	20%
7,50,001 - 20,00,000	30%
Above 20,00,000	36%

According to the income threshold, how much tax should be paid by an entrepreneur having the following yearly income?

- (a) Yearly income = Rs. 6,30,000
 - (b) Yearly income = Rs. 9,25,000
 - (c) Yearly income = Rs. 17,88,000
 - (d) Yearly income = Rs. 22,25,000
4. What is the total interest of Rs. 10 lakh deposited in a bank when calculated at the rate of 8.5% simple interest in 4 years? If 5% income tax is levied on that interest, then what is the net simple interest? Find out. (Thus, income tax paid on interest refers to the tax paid on investment income.)

Project Work

- (a) Collect the actual details of the salary of the level secondary teachers working in your school, including including description of employees provident fund, citizen investment fund and insurance, calculate how much tax each teacher has to pay in annual income.
- (b) If the student's family members have jobs, calculate the income from them and get the actual details and find out the amount of tax to be paid annually.

Answers

1. Rs. 6,550 2. Rs. 63,500 3. (a) Rs. 26,000 3. (b) Rs. 1,02,500
3. (c) Rs. 3,61,400 3. (d) Rs. 5,06,000 4. Rs. 3,40,000 and Rs. 3,23,000

2.1.2 Value added tax

Activity 1

Study the following bill and discuss the questions given below:

ABC Electronics
Kathmandu
TAX INVOICE

Invoice No. 883

Date: 2077-11-15

VAT No.

M/s

Address:

Buyers VAT No.: Mode of Payment: Cash/Cheque/Others

S.N.	Particulars	Quantity	Rate	Amount	
1.	Refrigerator			Rs.	Ps.
	C,LD 201 ALLB	1	27,876.10	27,876	10
Amount in Words: Thirty One Thousand Five hundred only.			Total	27,876	10
		 Discount	—	
			Taxable Amount	27,876	10
			13% VAT	3,623	90
			Grand Total	31,500	00

Customer's Sign

For. ABC Electronics

- What is the sales rate of refrigerator in the given bill?
- Did the refrigerator buyer get a discount or not?
- It is seen that the buyer has paid more than the selling rate, why did this happen?
- According to the bill, Rs. 3,623.90 more amount seems to have been paid in the sale rate. Why is the extra amount paid?
- Do we have to pay extra amount for the selling price when buying any goods?
- What price of refrigerator does Rs. 31,500 paid by the buyer refer to here?

Value Added Tax (VAT)

Value added tax is a kind of indirect tax levied on goods and services. Value added tax is the tax levied on the increased price at various levels/ stages from production to distribution of goods or services. At present, the rate of value added tax in Nepal is 13 %.

From Mathematical Technical Dictionary,

Value Added Tax: A value added tax (VAT) is a tax levied on the price that increases at each level by deducting a discount when selling goods or services. This tax should be paid by the consumer at the end but it does not allow the price of the commodity to increase unnecessarily.

A company that manufactures television set fixed the price of a television set at Rs. 10,000 by adding production cost and profit. The following process is completed when the television produced by the company reaches to the consumer through the dealer, wholesaler and retailer.

When the manufacturing company sells to the dealer	When the dealer sells to the wholesaler
The price of a television set = Rs. 10,000 Rate of value added tax = 13% Selling Price, $= \text{Rs. } 10,000 + 13\% \text{ of Rs. } 10,000$ $= 10,000 + 10,000 \times \frac{13}{100}$ $= 10,000 + 1,300$ $= \text{Rs. } 11,300$	Cost Price = Selling Price of manufacturing company = Rs. 11,300 Price of television including extra expenses and profit of Rs. 1200 = Rs. 12,500 Rate of value added tax = 13% Selling Price, $= \text{Rs. } 12,500 + 13\% \text{ of Rs. } 12,500$ $= \text{Rs. } 12,500 + \text{Rs. } 1,625$ $= \text{Rs. } 14,125$

When the wholesaler sells to the retailer	When the retailer sells to the consumer
Cost Price = Selling Price of dealer = Rs. 14,125 Price of television including extra expenses and profit of Rs.875 = Rs. 15,000 Rate of value added tax = 13% Selling Price = Rs. 15,000 + 13% of Rs. 15,000 = 15,000 + 1,950 = Rs. 16,950	Cost Price = Selling Price of wholesaler = Rs. 6,950 Price of television including extra expenses and profit of Rs.,050 = Rs. 8,000 Rate of value added tax = 13% Selling Price = Rs. 18,000 + 13% of Rs. 18,000 = Rs. 18,000 + $\frac{13}{100} \times$ Rs. 18,000 = Rs. 18,000 + Rs. 2340 = Rs. 20,340
Here, consumer has to pay Rs. 2,340 value added tax. When the amount is deposited in the government treasury, Manufacturer = Rs. 1,300 Dealer = (1,625 – 1,300) = Rs. 325 Wholesaler = (1,950 – 1,625) = Rs. 325 Retailer = (2,340 – 1,950) = Rs. 390 Total = 1,300 + 325 + 325 + 390 = Rs. 2,340	

Now, based on the increased value of each level,

Manufacturer = 13% of Rs. 10,000

$$= \frac{13}{100} \times \text{Rs. } 10,000 = \text{Rs. } 1,300$$

Dealer = 13% of Rs. (12,500 – 10,000)

$$= \frac{13}{100} \times \text{Rs. } 2500$$

$$= \text{Rs. } 325$$

Wholesaler = 13% of Rs. (15,000 – 12,500)

$$= \frac{13}{100} \times \text{Rs. } 2500$$

$$= \text{Rs. } 325$$

Retailer = 13% of Rs. (18,000 – 15,000)

$$= \frac{13}{100} \times \text{Rs. } 3,000$$

$$= \text{Rs. } 390$$

Total value added tax = Rs. 1,300 + Rs. 325 + Rs. 325 + Rs. 390 = Rs.2,340

Example 1

Find the value added tax (VAT) in the given cases:

- (a) Price without value added tax = Rs.700, rate of value added tax = 13%
- (b) Marked price without value added tax(MP) = Rs. 10,000, Discount = 15% and rate of value added tax = 13%

Solution,

- (a) Here, Price without value added tax = Rs. 7,000
Rate of value added tax = 13%
Value added tax amount =?

Now, value added tax amount = 13% of Rs.7000
 $= \frac{13}{100} \times \text{Rs. } 7,000$
 $= \text{Rs. } 910$

\therefore Value added tax amount = Rs. 910

- (b) Marked price without value added tax(MP) = Rs. 10,000
Discount = 15% and
Rate of value added tax = 13%
Value added tax amount =?

Now, finding discount amount,
Discount amount = 15% of Rs. 10,000
 $= \frac{15}{100} \times \text{Rs. } 10,000$
 $= \text{Rs. } 1,500$

Price after deducting the discount = Rs. 10,000 – Rs. 1500
 $= \text{Rs. } 8,500$

Now, value added tax amount = 13% of Rs. 8,500
 $= \frac{13}{100} \times \text{Rs. } 8,500$
 $= \text{Rs. } 1,105$

\therefore Value added tax amount = Rs. 1,105

Example 2

A mobile set was marked at Rs. 15,000. What is the value of the mobile set after allowing a discount of 15% and adding 13% value added tax? Calculate.

Solution,

Here, the marked price of mobile set without VAT (MP) = Rs. 15,000

$$\text{Discount} = 15\%$$

$$\text{Rate of VAT} = 13\%$$

$$\text{Price with VAT} = ?$$

$$\begin{aligned}\text{Now discount amount} &= 15\% \text{ of Rs. } 15,000 \\ &= \frac{15}{100} \times \text{Rs. } 15,000 \\ &= \text{Rs. } 2,250\end{aligned}$$

$$\begin{aligned}\text{Again, value added taxable amount} &= \text{Rs. } (15,000 - 2,250) \\ &= \text{Rs. } 12,750\end{aligned}$$

$$\begin{aligned}\text{Value added tax amount} &= 13\% \text{ of Rs. } 12,750 \\ &= 12,750 \times \frac{13}{100} \\ &= \text{Rs. } 1,657.50\end{aligned}$$

$$\begin{aligned}\therefore \text{Price with value added tax} &= 12,750 + 1,657.50 \\ &= \text{Rs. } 14,407.50\end{aligned}$$

Alternative Method

Solution,

Price of mobile without value added tax (MP) = Rs. 15000

After giving 15% discount,

$$\begin{aligned}\text{Price after discount} &= 85\% \text{ of Rs. } 15,000 \\ &= \frac{85}{100} \times \text{Rs. } 15,000 \\ &= \text{Rs. } 12,750\end{aligned}$$

After adding 13% VAT,

$$\begin{aligned}\text{Price with VAT} &= 113\% \text{ of Rs. } 12,750 \\ &= \frac{113}{100} \times \text{Rs. } 12,750 \\ &= \text{Rs. } 14,407.50\end{aligned}$$

From model drawing method,

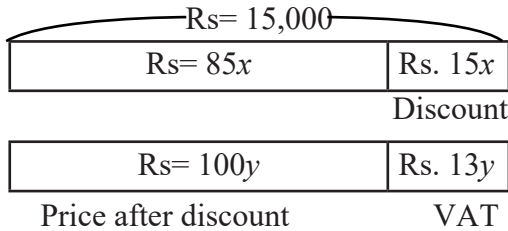

Now, $100x = \text{Rs. } 15,000$

$$x = \frac{15,000}{100} = \text{Rs. } 150$$

$85x = \text{Rs. } 150 \times 85 = 12,750$

Again, $100y = 85x$

$$= 12,750$$

$$y = \frac{12,750}{100}$$

$$\begin{aligned} 113y &= \frac{12,750}{100} \times 113 \\ &= \text{Rs. } 14,407.50 \end{aligned}$$

\therefore Price with value added tax = Rs. 14,407.50

Example 3

If a buyer has to pay Rs. 57,630 for an article after deducting 15 % discount on the price excluding value added tax and adding 13% value added tax, find the marked price of the article.

Solution,

Let the marked price excluding value added tax (MP) = Rs. x

Given discount = 15%

Rate of value added tax = 13%

Price with value added tax = Rs. 57,630

According to the question, Discount amount = 15% of x

$$\begin{aligned} &= \frac{15}{100} \times x \\ &= \frac{15x}{100} \end{aligned}$$

$$= \text{Rs. } \frac{3x}{20}$$

Value added taxable amount

$$= \text{Rs. } \left(x - \frac{3x}{20} \right)$$

$$= \text{Rs. } \frac{17x}{20}$$

Value added tax amount = 13% or Rs. $\frac{17x}{20}$

$$= \frac{17x}{20} \times \frac{13}{100}$$

$$= \text{Rs. } \frac{221x}{2,000}$$

Price with value added tax

$$= \text{Rs. } \left(\frac{17x}{20} + \frac{221x}{2000} \right)$$

$$= \text{Rs. } \left(\frac{1700x + 221x}{2000} \right)$$

$$= \text{Rs. } \frac{1921x}{2000}$$

According to the question,

$$\frac{1921x}{2000} = 57630$$

$$\text{or, } 1921x = 2000 \times 57630$$

$$\text{or, } x = \left(\frac{2,000 \times 57,630}{1921} \right)$$

$$\text{or, } x = 60,000$$

$$\therefore \text{Marked Price (MP)} = \text{Rs. } 60,000$$

From model drawing method,

Marked Price	
Rs. 85x	Rs. 15x
Discount	
Rs. 100y	Rs. 13y
Rs = 57,630	

Now, $113y = \text{Rs. } 57,630$

$$y = \frac{\text{Rs. } 57630}{113}$$

$$100y = \text{Rs. } 51,000$$

Again, $85x = \text{Rs. } 51,000$

$$x = \frac{51,000}{85}$$

$$100x = \text{Rs. } 60,000$$

\therefore Marked Price (MP) = Rs. 60,000

Alternative Method

Let the marked price excluding value added tax (MP) = Rs. x

Given discount = 15%

Rate of value added tax = 13%

Price with value added tax = Rs. 57,630

$$\begin{aligned}\text{Price with value added tax} &= (100 - 15)\% \text{ of Rs. } x \times (100 + 13)\% \\ &= \frac{85}{100} \times x \times \frac{113}{100}\end{aligned}$$

According to the question,

$$\begin{aligned}\text{Rs. } 57,630 &= x \times \frac{85}{100} \times \frac{113}{100} \\ \text{or, } x &= \frac{57630 \times 100 \times 100}{85 \times 113} \\ \text{or, } x &= 60,000\end{aligned}$$

\therefore Marked Price (MP) = Rs. 60,000

Example 4

A shopkeeper has bought a bicycle for Rs. 5,800 excluding value added tax. He has fixed the marked price by increasing 40 % on cost price. Find out how much the consumer has to pay when allowing 13 % value added tax with a 10% discount on the marked price.

Solution,

Here the cost price of bicycle excluding value added tax (CP) = Rs. 5,800

Discount = 10%

Rate of value added tax = 13%

Price with value added tax = ?

Profit % or Loss % = ?

From the question,

$$\begin{aligned}\text{Marked price of bicycle (MP)} &= (100 + 40)\% \text{ of Rs. } 5,800 \\ &= \frac{140}{100} \times \text{Rs. } 5,800 \\ &= \text{Rs. } 8,120\end{aligned}$$

Discount amount = 10 % of marked price

$$\begin{aligned}&= \frac{10}{100} \times \text{Rs. } 8120 \\ &= \text{Rs. } 812\end{aligned}$$

$$\begin{aligned}\therefore \text{Taxable income for value added tax} &= \text{Rs. } 8,120 - \text{Rs. } 812 \text{ [MP - discount amount]} \\ &= \text{Rs. } 7,308\end{aligned}$$

$$\begin{aligned}\text{Now value added tax amount} &= 13\% \text{ of Rs. } 7,308 \\ &= \frac{13}{100} \times \text{Rs. } 7,308 \\ &= \text{Rs. } 950.04\end{aligned}$$

$$\begin{aligned}\therefore \text{Price of bicycle with value added tax} &= \text{Rs. } 7,308 + \text{Rs. } 950.04 \\ &= \text{Rs. } 8,258.04\end{aligned}$$

Thus, the consumer has to pay Rs. 8,258.04.

Example 5

If a shopkeeper sells a watch purchased at Rs. 2000 excluding value added tax at a profit of 25%, find out how much the consumer will have to pay on the bill after 13% value added tax.

Solution,

Here cost price of the watch (CP) = Rs. 2,000

Profit = 25%

Rate of value added tax = 13%

Amount to be paid by the consumer (price with VAT) = ?

Profit = 25% of Rs. 2000

$$\begin{aligned}&= \frac{25}{100} \times 2,000 \\ &= \text{Rs. } 500\end{aligned}$$

$$\begin{aligned}\therefore \text{Taxable amount for value added tax} &= \text{cost price} + \text{profit} \\ &= \text{Rs.}(2,000 + 500) \\ &= \text{Rs. } 2500\end{aligned}$$

Value added tax amount = 13% of Rs. 2500

$$\begin{aligned}&= \frac{13}{100} \times \text{Rs. } 2,500 \\ &= \text{Rs. } 325\end{aligned}$$

$$\begin{aligned}\therefore \text{Amount to be paid by the consumer} &= \text{Rs. } 2,500 + \text{Rs. } 325 \\ &= \text{Rs. } 2,825\end{aligned}$$

Example 6

The sports goods dealer has bought a table tennis board from a importer for Rs. 25,000 excluding value added tax. He sells that table tennis board to retailer for Rs.30,000 excluding value added tax. That retailer sells it to Bikki for Rs. 37,000 excluding value added tax. Find the answers of the following questions based on the 13% value added tax rate at each level:

- What is the cost price of the dealer?
- What is the cost price of the retailer?
- How much will Bikki pay to buy it?
- How much of the value added tax from the sale of table tennis board is deposited in the government treasury?
- How much should the dealer and retailer deposit value added tax in the the government treasury?

Solution,

Sale price excluding value added tax fixed by the importer = Rs.25,000

Rate of value added tax = 13%

$$\begin{aligned}\text{(a) Cost price of the dealer} &= 25,000 + 13\% \text{ of } 25,000 \\ &= 25,000 + \frac{13}{100} \times 25,000 \\ &= 25,000 + 3,250 \\ &= \text{Rs. } 28,250\end{aligned}$$

Here, selling price of dealer adding profit and other expenses excluding value added tax = Rs. 30,000

$$\begin{aligned}\text{(b) Cost price of retailer} &= 30,000 + 13\% \text{ of } 30,000 \\ &= 30,000 + \frac{13}{100} \times 30,000 \\ &= 30,000 + 3,900 \\ &= \text{Rs. } 33,900\end{aligned}$$

Here selling price of retailer adding profit and other expenses excluding value added tax = Rs. 33,900

$$\begin{aligned}\text{(c) Now, the cost price of Bikki} &= 37,000 + 13\% \text{ of } 37,000 \\ &= \text{Rs. } 37,000 + \frac{13}{100} \times 37,000 \\ &= \text{Rs. } 37,000 + 4,810 \\ &= \text{Rs. } 41,810\end{aligned}$$

- (d) The value added tax from the sale of table tennis board deposited in the government treasury = Rs. 4,810
- (e) Calculating the value added tax deposited by the dealer in the government treasury,

First Method	Second Method
The value added tax he collected = Rs. 3,900	Amount to be deposited in government treasury
The value added tax he paid = Rs. 3,250	13% of (Rs. 30,000 – Rs. 25,000)
Amount to be deposited in government treasury	$= \frac{13}{100} \times 5,000$
= Rs. 3,900 – Rs. 3,250	= Rs. 650
= Rs. 650	

Calculating the value added tax deposited the by retailer in the government treasury,

First Method	Second Method
The value added tax he collected = Rs. 4,810	Amount to be deposited in government treasury =
The value added tax he paid = Rs. 3,900	13 % of (Rs. 37,000 – Rs. 30,000)
Amount to be deposited in government treasury	$= \frac{13}{100} \times 7,000$
= Rs. 4,810 – Rs. 3,900	= Rs. 910
= Rs. 910	

Exercise 2.2

1. Find the value added tax amount based on the given table:

S.N.	Price excluding value added tax	Rate of value added tax	Value added tax amount
(a)	Rs. 300	13%	?
(b)	Rs. 750	13%	?
(c)	Rs. 6,000	13%	?
(d)	Rs. 3,75,000	13%	?
(e)	Rs. 20,27,000	13%	?

2. Calculate the price excluding value added tax based on the given table:

S.N.	Price excluding value added tax	Value added tax amount	Rate of value added tax
(a)	?	? = 3,616	13%
(b)	?	? = 30,510	13%
(c)	?	? = 3,390	13%
(d)	?	? = 57,630	13%
(e)	?	? = 1,19,328	13%

3. Calculate the price that the customer has to pay for the given goods:

- (a) **Marked price without VAT = Rs. 35,000**
 Discount = 10%
 VAT = 13%



- (b) **Marked price without VAT = Rs. 6,500**
 Discount = 7.5%
 VAT = 13%



- (c) **Marked price without VAT = Rs. 25,700**
 Discount = 15%
 VAT = 13%



- (b) **Marked price without VAT = Rs. 1,450**
 Discount = 22.75%
 VAT = 13%



4. Calculate the actual price of the goods based on the information given in the following table:

S.N.	Marked price excluding VAT	Rate of Discount	Rate of VAT	Price with VAT
(a)	Rs. 2,000	8%	13%	?
(b)	Rs. 7,000	15%	13%	?
(c)	Rs. 27,000	20%	13%	?
(d)	Rs. 20,525.30	10%	13%	?
(e)	Rs. 1,81,500	7.5%	13%	?

5. The marked price of a LED television set excluding value added tax is Rs. 37,500. If it is sold after 11% discount and 13% VAT is levied on it, how much will the consumer pay? Find out by calculation.

6. Find the marked price and discount amount based on the given table:

S.N.	Marked price excluding VAT	Rate of Discount	Discount Amount	Rate of VAT	Price with VAT
(a)	?	20%	?	13%	Rs. 4,520
(b)	?	10%	?	13%	Rs. 15,225
(c)	?	15%	?	13%	Rs. 57,630
(d)	?	25%	?	13%	Rs. 2,151.52
(e)	?	15%	?	13%	Rs. 2,40125

7. If the price of an electric kettle after allowing 5 % discount on the marked price excluding value added tax and adding 13 % VAT is Rs. 1,575, What will be the marked price of that kettle? Find the taxable price for valued added tax.

8. A shopkeeper bought an article for Rs. 27,500 excluding value added tax and marked its price Rs. 35,000. When selling the article after allowing 10.5% discount and levying 13% VAT,

- What is the price including value added tax?
- What is the percentage of profit or loss from this transaction?
- If he could sell at the marked price, what percentage of profit would he get?

9. **A shopkeeper bought a watch for Rs. 4,000 excluding value added tax and labelled its price 25% above the cost price. After allowing 12 % discount and levying 13 % VAT,**
- (a) How much does the consumer have to pay for value added tax?
 - (b) If it is sold at a loss of 5%, what will be its price with value added tax?
10. A wholesaler sold a washing machine to a retailer at Rs. 67,000 including 13% value added tax. If the retailer delivered the machine to the consumer's house with transportation charge Rs. 3,000, local tax Rs. 550 and a profit of Rs. 5,000, how much would the consumer pay for value added tax at the current rate? Find out.
11. A wholesaler of watch bought a watch from a dealer at Rs. 12,000 excluding value added tax and sold it to a retailer at Rs. 16,950 including value added tax. If the rate of value added tax is 13 % at each level,
- (a) How much did the retailer pay for the watch except the value added tax?
 - (b) How much did the retailer pay for value added tax?
 - (c) How much profit did the dealer make?

Project Work

Be divided your friends into appropriate number of groups. Study the budget statement for the current fiscal year. Collect the following information from that budget statement and prepare a report in a group:

- (a) Size of the budget
- (b) Different types of taxes imposed in the budget
- (c) Rate of value added tax
- (d) Goods or services exempt from tax
- (e) Goods subject to value added tax
- (f) Other income tax

Answers

1. (a) Rs. 39 (b) Rs. 97.50 (c) Rs. 780 (d) Rs. 48,750
(e) Rs. 2,63,510
2. (a) Rs. 3,200 (b) Rs. 27,000 (c) Rs. 3,000 (d) Rs. 51,000
(e) Rs. 1,05,600
3. (a) Rs. 35,595 (b) Rs. 6,794.13 (c) Rs. 24,684.85 (d) Rs. 1,265.74
4. (a) Rs. 20,79.20 (b) Rs. 67,23.50 (c) Rs. 24,408 (d) Rs. 20,874.23
(e) Rs. 189712.88
5. Rs. 37,713.75
6. (a) Rs. 60,000, Rs. 9000 (b) Rs. 5,000, Rs. 1000
(c) Rs. 2,50,000, Rs. 37500 (d) Rs.14,970.50, Rs. 1497.05
(e) Rs. 2,538.67, Rs. 34.67
7. Rs. 1,393.81 and Rs.1,467.16
8. (a) Rs. 35,397.25 (b) 13.91% (c) 27.27%
9. (a) Rs. 572 (b) Rs. 4,294
10. Rs. 10,953.80
- 11.(a) Rs. 15,000 (b) Rs. 1,950 (c) Rs. 3,000

Lesson 3

Commission and Dividend

3.1 Commission

Activity 1

Form three groups from your classmates. Act as a land owner (name: Dhaniram), the leader of the first group, as a buyer (name: Aadinath), the leader of the second group and agent as a mediator (name: Sabina), the leader of the third group. A person acting as an intermediary between a seller and a buyer of goods and services is called an agent.

In this way, the amount that the agent receives at the rate of certain percentage of sale price for performing the role of mediator is called the commission. Agent can receive such amount from buyer or seller or both. The sale price is taken as the basis when taking and giving commission. Commission is expressed in percentage. Commissions are calculated in land transactions, on financial transaction in banks and financial institution, in insurance company, buying and selling goods etc.

Example 1

If an agent receives 5% commission by selling a land for Rs. 25,00,000, then

- How much amount does the agent receive as the commission?
- How much money is in the hand of the land owner after commission? Find out.

Solution,

Here selling price of land = Rs. 25,00,000

Rate of commission = 5%

(a) Amount of commission = ?

(b) The amount received by the land owner = ?

(a) We know that,

Amount of commission = 5 % of Rs. 25,00,000

$$\begin{aligned} &= \frac{5}{100} \times \text{Rs. } 25,00,000 \\ &= \text{Rs. } 1,25,000 \end{aligned}$$

∴ Amount of commission = Rs. 1,25,000

(b) The amount received by the land owner
 = price after commission = selling price - commission amount
 = 25,00,000 - 1,25,000
 \therefore The amount received by the land owner = Rs. 23,75,000

Example 2

The rate of commission paid by a company to agent is given below:

- 0.5% in the sale up to Rs. 15,00,000
- 1 % in the sale above Rs. 15,00,000 up to Rs. 25,00,000
- 1.5% in the sale above Rs. 25,00,000 up to Rs. 40,00,000
- 2 % in the sale above Rs. 40,00,000

How much total commission does an agent receive in a sale of Rs. 60 lakhs, based on the above rate of commission?

Solution,

Here, writing the selling price Rs. 60,00,000 breaking down according to the ceiling of commission rate,

$$\text{Rs. } 60,00,000 = \text{Rs. } 15,00,000 + \text{Rs. } 10,00,000 + \text{Rs. } 15,00,000 + \text{Rs. } 20,00,000$$

\downarrow
0.5%

\downarrow
1%

\downarrow
1.5%

\downarrow
2%

$$\begin{aligned} \text{Total Commission Amount} &= 0.5\% \text{ of Rs. } 15,00,000 + 1\% \text{ of Rs. } 10,00,000 \\ &\quad + 1.5\% \text{ of Rs. } 15,00,000 + 2\% \text{ of Rs. } 20,00,000 \end{aligned}$$

$$\begin{aligned} &= \text{Rs. } \left\{ \frac{0.5}{100} \times 15,00,000 \right\} + \left\{ \frac{1}{100} \times 10,00,000 \right\} \\ &\quad + \left\{ \frac{1.5}{100} \times 15,00,000 \right\} + \left\{ \frac{2}{100} \times 20,00,000 \right\} \\ &= 7,500 + 10,000 + 22,500 + 40,000 \end{aligned}$$

\therefore Total Commission Amount = Rs. 80,000

Example 3

Monthly salary of an employee working in a construction material shop is Rs. 12,000. He also gets commission for selling goods. He has sold construction materials worth Rs. 4,75,000 in a month. If he earns the total amount of Rs. 19,125 in that month, what is the rate of the commission?

Solution,

Selling Amount = Rs. 4,75,000

Monthly salary of the employee = Rs. 12,000

Employee's monthly income including commission = Rs. 19,125

$$\begin{aligned}\therefore \text{Commission Amount} &= \text{Rs. } 19,125 - \text{Rs. } 12,000 \\ &= \text{Rs. } 7,125\end{aligned}$$

$$\begin{aligned}\text{Now, rate of commission} &= \frac{\text{Commission Amount}}{\text{Selling Amount}} \times 100\% \\ &= \frac{7,125}{4,75,000} \times 100\% \\ &= 1.5\%\end{aligned}$$

Example 4

Monthly salary of a staff working in a bookstore is Rs. 16,000. If he sells books worth more than Rs. 5,00,000 a month, he is paid a commission of 2%. If the total sales of the shop for the month of Baisakh is Rs. 7,25,000, what is the total income of the staff in that month? Find it.

Solution,

Here, the monthly salary of the staff = Rs. 16,000

Total selling amount of the month of Baisakh = Rs. 7,25,000

Rate of commission = 2%

Monthly income of the staff = ?

Writing the total selling amount according to the ceiling of commission,

$$\text{Rs. } 7,25,000 = \text{Rs. } 5,00,000 + \text{Rs. } 2,25,000$$

Rate of commission = 2%

Now, the amount of commission = 2% of Rs. 2,50,000

$$= \frac{2}{100} \times \text{Rs. } 2,50,000$$

$$= \text{Rs. } 5,000$$

$$\begin{aligned}\text{Thus, the total income of that staff of the month of Baisakh} &= \text{Rs. } (16,000 + 5000) \\ &= \text{Rs. } 21,000\end{aligned}$$

Exercise 3.1

1. Find the amount of commission based on the given table:

S.N.	Particulars (Items)	Total Selling Price	Rate of Commission
(a)	Land	Rs.1 crore 50 lakh	5%
(b)	House	Rs.2 crore	3%
(c)	Photocopy machine	Rs. 4 lakhs	7.5%
(d)	Share transaction	Rs. 5 corer 25 lakh	2%

2. If an agent receives 5% commission by selling a house for Rs.1,40,00,000 then,

- (a) How much amount does the agent receive as the commission?
(b) How much amount does the showroom have to pay to the employees for commission? Calculate.

3. A motorcycle showroom has 10 employees who get Rs. 20,000 as salary per month. They get 0.25% commission from the total monthly sale. If the total transaction in Asoj is Rs. 1,35,00,000,

- (a) How much amount does the showroom provide to the employees as the commission? calculate.
(b) What percentage in more in the monthly income of an employee than the monthly salary?

4. A company producing plastic goods gives commission to its seller at the rate of 1% in a selling amount up to Rs. 6,00,000, 1.5% above Rs. 6,00,000 up to Rs. 10,00,000 and 2% in a selling amount above Rs. 10,00,000, then find the amount of commission received by the seller in the following selling amount:

(a) Rs. 4,45,600 (b) Rs. 7,25,000 (c) Rs. 15,75,000

5. The monthly salary of a staff working in a cosmetic shop is Rs. 17,000. He gets a certain percentage of commission on the total sales. In the month of Manshir he earns Rs. 30,000 including commission on the total selling price of Rs.10,00,000 in that month, how much amount of commission does he get from the shop?

Project Work

Visit a company or a shop nearby. Ask staff or operator about the following, prepare a report and present in your class:

- (a) Sales provision
- (b) Plan for additional sales facilities for staffs.

Answers

1. (a) Rs. 7,50,000 1. (b) Rs. 6,00,000 1. (c) Rs. 30,000 1. (d) Rs. 10,50,000
2. (a) Rs. 7,00,000 2. (b) Rs. 1,33,00,000 3. (a) Rs. 3,37,500 3. (b) 168.75%
4. (a) Rs. 4,456 4. (b) Rs.7,875 4. (c) Rs. 23500 5. 1.3%

3.2 Bonus

Activity 1

The edited excerpt of the news item entitled Oil Corporation distributing 6 crore bonus to employees' published in the Naya Patrika Daily of 2077 Poush 24 is as follows:

Nepal Oil Corporation is going to distribute bonus to the employees. The corporation has decided to distribute bonus to the employees in view of the legal provision of distributing bonus in the year of profit. Yet the corporation has to get the permission of the government to give bonus to the employees.

Oil Corporation is going to distribute around 6 crores to the employees from the amount allocated for the bonus of two fiscal years 2075/076 and 2076/077. According to the official president of trade union of the corporation, Gopal Rai, it has been decided to distribute bonus equal to two months and 15 days to the assistant level employees and two months' salary to the officer level or higher level employees. "We believe that performance will be more effective if bonuses can be distributed to the employees." He said ' We are hopeful that Ministry of Finance will approve it this time."

The Bonus Act provides for a bonus of up to 1 % of the net profit to be distributed to the employees of public enterprises. The law also stipulates that a maximum of 3 months' salary is equal to the bonus received by an employee in a fiscal year. The corporation has to distribute the bonus amount to the employees and deposit the remaining 80% to the government fund and 20 % in the welfare fund of the corporation.

Study the news except given above and answer the given questions.

- Why would a company provide bonus?
- On what basis is the bonus distributed?
- Does a company distribute bonus if it cannot each profit?

In addition to the regular salary that an employee receives from his or her work, a certain percentage of that profit is paid annually to the employee as a lump sum incentive if the employee is able to earn a profit from the organization in which he or she works is called the bonus. In case of Nepal, if Nepal Electricity Authority, Nepal Telecom, Nepal Oil Corporation, Nepal Water Supply Corporation and other private institutions including several banks make a profit, the employees working in such institutions will get a lump sum bonus annually as per the rules and regulations.

Example 1

An industry has made a profit of Rs. 40,00,000 in a year. It has decided to distribute 60 % of profit to 80 employees working in that industry, find out how much amount each employee will receive as a bonus that year.

Solution,

Total profit = Rs. 40,00,000

Bonus amount to be distributed = 60% of Rs. 40,00,000

$$\begin{aligned} &= \frac{60}{100} \times 40,00,000 \\ &= \text{Rs. } 24,00,000 \end{aligned}$$

Total number of employees = 80

$$\begin{aligned} \text{Bonus amount received by an employee} &= \text{Rs. } \frac{24,00,000}{80} \\ &= \text{Rs. } 30,000 \end{aligned}$$

∴ Each employee receives Rs. 30,000 as a bonus in that year.

Example 2

A hotel has made a profit of Rs. 50,00,000 in a year. A certain percentage of profit was distributed to 55 employees working in that hotel equally at the rate of Rs. 50,000, what percentage of profit did the hotel distribute? Calculate.

Solution

Total yearly profit of the hotel = Rs. 50,00,000

Bonus distributed to each employee = Rs. 50,000

Total number of employee = 55

Percentage of bonus distributed = ?

$$\begin{aligned} \text{Total amount distributed for bonus} &= 55 \times \text{Rs. } 50,000 \\ &= \text{Rs. } 27,50,000 \end{aligned}$$

$$\begin{aligned} \therefore \text{Percentage of bonus distributed} &= \frac{27,50,000}{50,00,000} \times 100\% \\ &= 55\% \end{aligned}$$

3.3 Dividend

Activity 2

The edited excerpt of the news item entitled " Telecom Passed Dividend" published in Gorkhapatra Online on 14th Chaitra, 2070 BS is as follows:

Nepal Telecom Company has passed a proposal to distribute cash dividend to the shareholders at the rate of Rs. 40 per share from the profits of the fiscal year 2076/77.

Study the above news excerpt.

Answer the question given below.

- What is share?
- Have you or a member of your family bought shares in a company?
- What is dividend? On what basis does the company distribute dividends?
- Companies distribute a portion of their profit to shareholders each year. Have you or your family received such amount?

If a certain percentage of the profit earned by the company on the basis of investing in shares in a company or profit oriented organization is given to the shareholder, then that amount is called dividend. When distributing dividends, a certain percentage of the net profit of the corporation is divided by the number of shares. There are two types of such dividends:

- Cash dividend
- Share dividend

Example 3

If a microfinance company has 6,00,000 unit of shares at the rate of Rs.100 and that company has made a profit of Rs.40,00,000 in a year. If the company decides to distribute 20 % of the profits as the cash dividend to its shareholders. Find how much cash dividend does the person who owns 60 shares of that company in the year?

Solution,

Here, total profit = Rs. 40,00,000

Cash dividend to be distributed = 20% of Rs. 40,00,000

$$= \frac{20}{100} \times 40,00,000$$

$$= \text{Rs. } 8,00,000$$

Again, total number of shares = 6,00,000

$$\text{Cash dividend for one share} = \frac{8,00,000}{6,00,000} \\ = \text{Rs. } 1.33$$

The dividend received from the company by the person having 60 shares = $60 \times \text{Rs. } 1.33$
= Rs. 80

Exercise 3.2

1. Calculate the bonus based on the following table:

Company	Profit	Rate of Bonus
(a)	Rs. 60 lakh	25%
(b)	Rs.2 crore 50 lakh	67.5%
(c)	Rs. 80 lakh	48%
(d)	Rs.9 crore	55%

- A textile industry has made a profit of Rs. 5 lakhs and sixty thousand in the year 2076 BS. It has decided to distribute 60 % of the profits as a bonus to 105 employees working in the industry, how much amount each will an employee receive? Find out.
- An insurance company has decided to distribute two third of the total profit equally to its 150 staffs as a bonus. If each staff receives Rs. 40,000, what is the total profit of the company in that year?

4. Calculate the total dividend and per share dividend from the given table:

Company	Total number of shares	Rate of Dividend	Net profit
(a)	4,50,000	40%	Rs. 50,00,000
(b)	1,15,62,486	55.5%	Rs. 12,00,00,000
(c)	3,28,50,000	23.5%	Rs. 5,20,60,000
(d)	21,63,25,030	60%	Rs. 2,75,67,36,894

- Suryalaxmi cooperative has 13,63,497 units of shares of Rs.100 each. Mamata has 350 units of share of that cooperative. If that cooperative earns Rs. 1 crore and 20 lakh in one year and decides to distribute cash dividend to its shareholder equal to 45 % of the profit, how much cash dividend does Mamata receive? Find out.

6. An insurance company having 22,39,440 units of shares of Rs.100 each earns profit Rs. 1,52,05,675 in a year. If the board of directors of that company has decided to distribute cash dividend to its shareholder equals to 65 % of total profit, how much cash dividend does a shareholder holding 280 units of shares receive? Calculate.

Project Work

Divide your classmates into 5 groups. Visit 5 different public or private financial company/organization. Collect the information of 5 companies about how they distribute bonus to their employees and 5 companies how they distribute dividend to their shareholders. Prepare report in a group and present in the classroom.

Answers

1. (a) Rs. 1,5,00,000 (b) Rs. 1,68,75,000
(c) Rs. 38,40,000 (d) Rs. 4,95,00,000
2. Rs. 3,200
3. Rs. 90,00,000
4. (a) Rs. 20,00,000 and Rs. 4.44 (b) Rs. 6,66,00,000 and Rs. 5.76
(c) Rs. 1,22,34,100 and Rs. 0.37 (d) Rs. 1,65,40,42,136 and Rs. 7.65
5. Rs. 1,386.14
6. Rs. 1,235.77

4.0 Review

Discuss and resolve the following questions:

- If the cost of 25 copies is Rs. 500, what is the cost of one copy?
- If the cost of 1 dozen copies is Rs.600, what is the value of 7 copies?
- How much is it if you add 10 % amount to your Rs. 750?
- What is the amount of 2 % discount on a calculator with a price of Rs 500? What is the price after discount?

We have already studied the calculation of unitary method, discount amount and value added tax amount in the previous class. The use of them makes it easy to calculate from the basic mathematical operations while paying the electricity bill, water and telephone bill consumed in our daily life.

Household expenses like electricity tariff, water tariff, telephone tariff, taxi fare etc. can also be paid online using apps in mobile or computer set. Nowadays, due to information and technology, the compulsion to physically attend the office for hours to pay various tariffs and fees is coming to an end.

4.1 Household expenses for use of electricity

Activity 1

The Nepal Electricity Authority has fixed the tariff rates for electricity services provided according to the capacity of electricity meter.

According to the electricity consumer tariff rate fixed from the 140 th meeting of the Electricity Regulatory Body in 2078/7/8,

Kilowatt-Hour unit	5 Ampere		15 Ampere		30 Ampere		60 Ampere	
	Service Charge (Rs.)	Service Charge (Rs.)	Service Charge (Rs.)	Service Charge (Rs.)	Service Charge (Rs.)	Service Charge (Rs.)	Service Charge (Rs.)	Service Charge (Rs.)
0 – 20	30	0	50	4.00	75	5	125	6
21 – 30	50	6.50	75	6.50	100	6.50	125	6.50
31 – 50	50	8.00	75	8.00	100	8.00	125	8.00
51 – 100	75	9.50	100	9.50	125	9.50	150	9.50
101 – 250	100	9.50	125	9.50	150	9.50	200	9.50
Above 250	150	11.00	175	11.00	200	11.00	250	11.00

Note: In case of 5 Ampere customer, if they consume more than 20 Kilowatt hour unit per month, energy charges up to 1 -20 Kilo watt hour unit will be charged at the rate of Rs. 3 per unt.

Study the above rate of tariff and the given bill, then discuss the questions given below with your friends:

Note: Kilo Watt is written as KW in short form.

- What month is the given bill for?
- According to the bill, how much capacity of meter is fixed?
- What capacity of meter is fixed in your house?
- How many units of electricity can be seen consumed in this bill this month?
- According to this bill, what is the minimum charge to be paid?
- How do you calculate the minimum charge of the meter fixed in your house?
- How much is the energy charge on the bill?
- What is meant by minimum charge in the above tariff rate table? What is meant of energy charge?
- What are the details mentioned in the bill lading from the automatic machine currently used in your meter?
- According to this bill, on which date was the meter reading done?

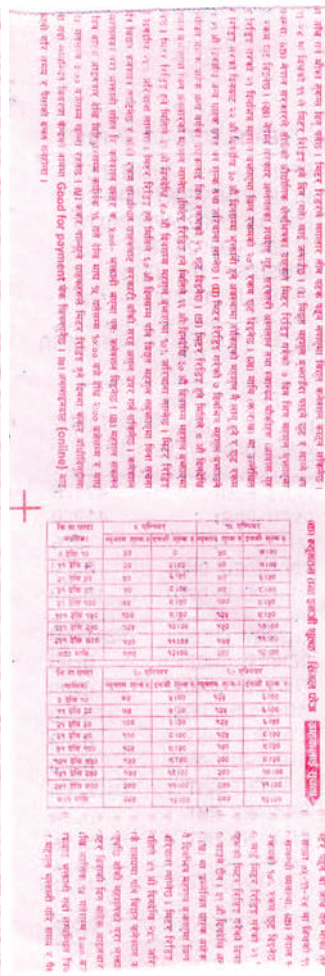
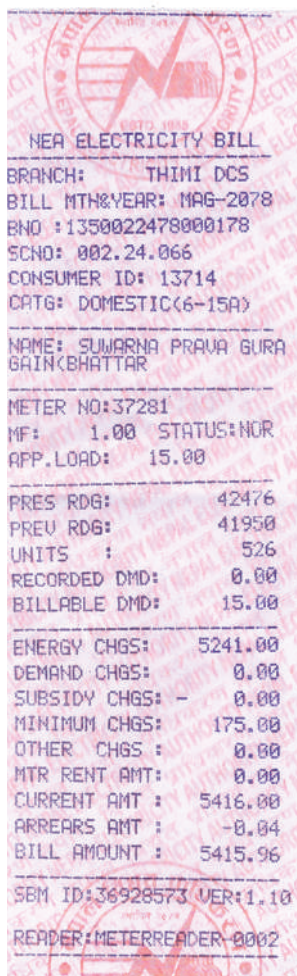

According to the electricity consumer tariff rate fixed from the 140th meeting of the Electricity Regulatory Body in 2078/7/8, the charge for single phase electricity consumption is billed as follows:

Method of Billing (for 5Ampere)			
S.N.	Consumed unit block	Rate per unit (Rs.)	Way of Billing
1.	0-20	0.00	Minimum charge is Rs. 30 and no energy charge
2.	From 21 to 30	6.50	Minimum charge: Rs. 50 Energy charge: up to 20 units at the rate of Rs.3 per unit, 21 to 30 units at the rate of Rs.6.50 per unit has to be paid.
3.	From 31 to 50	8.00	Minimum charge: Rs. 50 and Energy charge: up to 20 units at the rate of Rs.3 per unit, <ul style="list-style-type: none"> • 21 to 30 units per unit Rs.6.50 • 31 to 50 units at the rate of Rs. 8.00 has to be paid
4.	From 51 to 100	9.50	Minimum charge: Rs. 50 and Energy charge: up to 20 units at the rate of Rs.3 per unit, <ul style="list-style-type: none"> • 21 to 30 units per unit Rs.6.50 • 31 to 50 units at the rate of Rs. 8.00 • 51 to 100 units at the rate of Rs. 9.50 per unit has to be paid.
5.	From 101 to 250	9.50	Minimum charge: Rs. 50 and Energy charge: up to 20 units at the rate of Rs.3 per unit, <ul style="list-style-type: none"> • 21 to 30 units per unit Rs.6.50 • 31 to 50 units at the rate of Rs. 8.00 • 51 to 250 units at the rate of 9.50 per unit has to be paid.

6.	Above 250 units	11.00	<p>Minimum charge: Rs. 50 and</p> <p>Energy charge: up to 20 units at the rate of Rs.3 per unit,</p> <ul style="list-style-type: none"> ● 21 to 30 units per unit Rs.6.50 ● 31 to 50 units at the rate of Rs. 8.00 ● 51 to 250 units at the rate of 9.50 ● Above 250 units at the rate of Rs. 11 per unit has to be paid.
7.	Above 400 units	12.00	<p>Minimum charge: Rs. 50 and</p> <p>Energy charge: up to 20 units at the rate of Rs.3 per unit,</p> <ul style="list-style-type: none"> ● 21 to 30 units per unit Rs.6.50 ● 31 to 50 units at the rate of Rs. 8.00 ● 51 to 250 units at the rate of 9.50 ● 251 to 400 units at the rate of Rs. 11 per unit ● Above 400 units at the rate of Rs. 12.00 per unit has to be paid.

Note: Similarly, the billing of 14, 30 and 60 Ampere are done.

The following provision of discount and penalties are provisioned for the customer in the rules while paying the tariff.

1. 2% discount is given if the bill is paid within 7 days from the date of meter reading.
2. Amount is taken according to the bill if it is paid from 8th day to 15th day from the meter reading date.
3. 5 % extra charge (fine or penalty) is added to the amount of bill if the bill is paid from 16th day to 30th day from the meter reading date.
4. 10 % extra charge (fine or penalty) is added to the amount of bill if the bill is paid from 31st day to 40th day from the meter reading date.
5. 25 % extra charge (fine or penalty) is added to the amount of bill if the bill is paid from 41st day to 60th day from the meter reading date.
6. If the electricity tariff is not paid by the 60th day of the meter reading date, the power will be cut off at any time without notice. The connection and the remaining amount will be recovered from the concerned customer like the government balance and the reconnection fee will be Rs.500.

The tariff rate of Nepal Electricity Authority varies according to the energy capacity of the meter connected to our house. When installing a meter with more capacity, we have to pay more than the minimum tariff. Similarly, the more electricity consumed, the more tariffs have to be paid. When the tariff is calculated, the amount received by the service provider is understood as the amount charged for consuming electricity. Currently, the Nepal Electricity Authority (NEA) has given high priority to the use of information technology (IT) for meter reading and payment of electricity tariff to the customer.

If the electricity tariff is paid within one week from the date of meter reading, exemption will be given, after one week if it is paid within 15 days, there is no discount or it is according to the bill amount, fine to pay if the tariff is paid after 15 days and if the tariff is not paid within 60 days, the Electricity Authority can cut the power line at any time and charges re connection fee are mentioned in the regulation.

Example 1

A meter of 5 Ampere capacity is fixed in Rambaran's house. Find out the electricity bill for the month of Push, 2078 BS by calculating the answers of the following questions based on the given two details:

PRESENT RDG = 42973

PREVIOUS RDG = 42828

RDG here in the bill means reading.

- How many units of electricity has been consumed in Rambaran's house in the month of Push?
- How much is the total tariff?
- If the tariff is paid on the 5th day from the date of meter reading, how much was the discount?
- How much money is required to pay the tariff on the 13th day from the date of meter reading?
- If the tariff was paid on the 22nd day of the meter reading, how much would Rambaran have been fined?
- If he had paid the tariff on the 39th day from the date of meter reading, how much fine would he have to pay?
- If the tariff is to be paid on the 50th day from the date of meter reading, now how much is required to be paid to Nepal Electricity Authority with additional fee? Calculate.

Solution,

Here, Present reading = 42973

Previous reading = 42828

(a) Consumed unit in the month of Push in Rambaran's house = $42973 - 42828$
= 145 units

- (b) Let's study the rate of tariff given in the previous page,
Being consumed unit is 145 units, and the capacity of meter is 5 ampere, 145 units lies in the group 101 to 150. According to that group 145 units can be broken as follows:

$$145 \text{ units} = 20 \text{ units} + 10 \text{ units} + 20 \text{ units} + 95 \text{ units}$$

↓	↓	↓	↓
Rs.3	Rs.6.50	Rs.8.00	Rs.9.50

Minimum charge = Rs.100

$$\begin{aligned} \text{Total energy charge} &= 20 \times 3 + 10 \times 6.50 + 20 \times 8.00 + 95 \times 9.50 \\ &= 60 + 65 + 160 + 902.50 \\ &= \text{Rs. } 1187.50 \end{aligned}$$

Minimum charge of the group (101-150) = Rs. 100

$$\begin{aligned} \text{Total tariff} &= \text{Minimum charge} + \text{Total energy charge} \\ &= \text{Rs. } 100 + \text{Rs. } 1187.50 \\ &= \text{Rs. } 1287.50 \end{aligned}$$

- (c) 2 % discount is given if the bill is paid within 7 days from the date of meter reading.

Here, if Rambaran pays the tariff on the 5th day,

$$\begin{aligned} \text{Discount amount in tariff} &= 2\% \text{ of Rs. } 1287.50 \\ &= \frac{2}{100} \times \text{Rs. } 1,287.50 \\ &= \text{Rs. } 25.75 \end{aligned}$$

- (d) As a rule, the amount is paid according to the bill if it is paid on 8th day to 15th day from the date of meter reading

Here, if Rambran pays the tariff on the 13th day, he has to pay the bill amount of Rs.1287.50

- (e) As a rule, 5% extra charge has to pay if the bill is paid on 16th day to 30th day from the date of meter reading.

Here, if Rambaran pays the bill on 22th day, he has to pay 5% extra charge.

So, the extra charge amount to be paid = 5 % of Rs.1287.50

$$= \frac{5}{100} \times \text{Rs. } 1,287.50$$

$$= \text{Rs. } 64.38$$

- (f) As a rule, 10 % extra charge has to pay if the bill is paid on 31st day to 40th day from the date of meter reading.

Here, Rambaran pays the bill on 39th day,

Extra charge to be paid (fine amount) = 10 % of Rs.1287.50

$$= \frac{10}{100} \times \text{Rs. } 1,287.50$$

$$= \text{Rs. } 128.75$$

- (g) As a rule, 25% extra charge has to pay if the bill is paid on 41st day to 60th day from the date of meter reading.

Here, Rambaran pays the bill on the 50th day,

Fine amount = 25 % of Rs.1287.50

$$= \frac{25}{100} \times \text{Rs. } 1,287.50$$

$$= \text{Rs. } 321.88$$

∴ Total amount of tariff with fine amount = Rs. 1, 287.50 + Rs. 321.88

$$= \text{Rs. } 1609.38$$

Exercise 4.1

1. A meter of capacity 5 ampere capacity is installed in Dambar Kumari Tamang's house. The meter reading of her house from the month Kartik to Fagun of the year 2078 BS is given in the following table. Study the table and answer the questions given below:

Month	Kartik	Manshir	Push	Magh	Fagun
Meter Reading Unit	3528	3593	3700	3904	3980

- (a) What is the total unit of electricity consumed on the month of Manshir?
- (b) In which months did Dambar Kumari's house consume the most and the least amount of electricity?
2. According to the current tariff rate, calculate the tariff to be paid to Nepal Electricity Authority in the following cases:
- (a) Present reading: 2575, Previous reading: 2472,
Capacity of meter: 5 Ampere
The bill is paid on the 4th day of meter reading.
- (b) Present reading: 3036, Previous reading: 2831,
Capacity of meter: 15 Ampere
The bill is paid on the 41st day of meter reading.
- (c) Present reading: 3603, Previous reading: 3294,
Capacity of meter: 30 Ampere
The bill is paid on the 39th thday of meter reading.
- (d) Present reading: 4311, Previous reading: 3944,
Capacity of meter: 60 Ampere
The bill is paid on the 14th day of meter reading.
- (e) Present reading: 5555, Previous reading: 5107,
Capacity of meter: 30 Ampere
The bill is paid on the 17th day of meter reading.
- (f) Present reading: 6452, Previous reading: 6443,
Capacity of meter: 5 Ampere
The bill is paid on the 57th day of meter reading.

Project Work

Collect the electricity bills of 6 months of your house or school. Show the teacher individually the process of calculation tariff with bills obtained from automatic machine.

Answers

- | | | |
|-------------------|--|------------------|
| 1. (a) 65 units | (b) Maximum: Magh and Minimum: Manshir | |
| 2. (a) Rs. 870.73 | (b) Rs. 2,378.13 | (c) Rs. 3,381.40 |
| (d) Rs. 3,782 | (e) Rs. 4,833.15 | (f) Rs. 37.50 |

4.2 Household expenses for use of water

Activity 1

Study the given bill of water consumed through a pipe of size $\frac{1}{2}$ inch and the rate of tariff table, then discuss on the questions given below, where 1000 liter = 1 unit.

- What are the details mentioned on the bill?
- How much is the bill amount?
- What is the discount amount on the bill?
- How much amount is paid for penalty on the bill? Why?
- How much is the arrears amount on the bill?
- How much is the sewerage charge?
- According to this bill, how many units of water have been consumed in the calculated month?

Kathmandu Upatyaka
Khanepani Limited

Branch: Tripureshwor
PAN No.: 600041601



PAYMENT DUPLICATE-RECEIPT

Receipt No.	:	1115117730000577
Date	:	2077-11-17
Customer ID	:	1115004313
Connection No	:	20198
Area No.	:	14C-17-55
Name	:	Jana bikas pra.bi.
Payment Mode	:	Cash
Cheque No	:	
Arrears	:	1083.00
Water Charges	:	100.00
Sewerage Charges	:	50
Meter Rent Charges	:	0.00
Miscellaneous	:	0.00
Penalty	:	200.50
Rebate	:	13.95
Previous Balance	:	0.00
Bill Amount	:	1238.00
Total To Be Paid	:	1424.55
Total Amt Paid Rs.	:	1425.00
Payment Period	:	2077 Shrawan - 2077 Falgun
Advance	:	0.45
Advance Rebute	:	0.01
Balance (After Paid)	:	0.46
Received By	:	(rbhattarai - 3)
----- Computer Generated Receipt-----		

Kathmandu Upatyaka Khanepani Limited
Head Office, Tripureshwar
 Tariff rate table applicable from Shrawan 1, 2070

Size of pipe (in inch)	Minimum consumption (in litre)	Minimum unit	In the meter connected taps	
			Minimum charge (in Rs.)	Based on the volume when more water is used (per 1000 litre) Rs.
½"	10000	10	100	32
¾"	27000	27	1,910	71
1"	56000	56	3,960	71
1.5"	155000	155	10,950	71
2"	320000	320	22,600	71
3"	881000	881	62,240	71
4"	1810000	1810	1,27,865	71

Note: 50% tariff is fixed for the sewage service being taken by the company at the tariff.

The above bill is calculated at the following tariff rate. According to the rules, a minimum of 10000 litre or 10 units of water (1 unit = 1000 litre) is consumed in a ½ inch pipe.

The exemption and penalty for payment of drinking water tariff will be as presented in the table below:

Payment (by the date the bill is distributed)	Discount / Fine
Within the first and second month	3 % discount
Within the third month	As per bill
Within the fourth month	10% Fine
Within the fifth month	20% Fine
After the fifth month	50% Fine

Example 1

A $\frac{1}{2}$ inch-sized pipe was found in the house of Sadikshya and the meter reading of water was 3754 during the month of Chaitra. If the meter reading in the month of Fagun was 3727, what is the tariff of Chaitra including 50% sewerage service? What will be the total tariff to be paid if the bill is paid within the second month?

Solution,

Here, Present reading = 3,754

Previous reading = 3,727

Consumed water = $3754 - 3727$
= 27 units

Charge of minimum 10 units (10000 litre) = Rs.100

Here, 27 unit = 10 units + 17 unit

Minimum charge Rs.100 at the rate of Rs.32 per unit

$$\begin{aligned}\therefore \text{Total tariff} &= 100 + 17 \times 32 \\ &= 100 + 544 \\ &= \text{Rs.}644\end{aligned}$$

Sewerage Charge = 50 % of Rs.644

$$\begin{aligned}&= \frac{50}{100} \times 644 \\ &= \text{Rs.} 322\end{aligned}$$

Total amount of bill = Rs.644 + Rs.322 = Rs.966

Thus, the total amount to be paid by Sadikshya in the month of Chairta for consuming water = Rs.966

As per rule, if Sadikshya pays the tariff within the second month from the date of bill distributing, she will get a discount of 3 %,

$$\begin{aligned}\text{Discount amount} &= 3 \% \text{ of Rs.}966 \\ &= \frac{3}{100} \times \text{Rs.} 966 \\ &= \text{Rs.} 28.98\end{aligned}$$

\therefore The amount to be paid by Sadikshya within the second month = Rs. 966 - Rs. 28.98
= Rs. 937.02

Example 2

123 units of water was consumed in a month at Central colony from a 1 inch sized water supply pipe. If the bill is paid within the fourth month from the bill distribution date, how much total fine amount has to be paid?

Solution,

Total consumption of water = 123 unit

Tariff for consumption of minimum 56 units (56000 liter) of water = Rs. 3,960

$$\begin{aligned}\text{Here, } 123 \text{ unit} &= 56 \text{ unit} + (123 - 56) \text{ unit} \\ &= 56 \text{ units} + 67 \text{ units}\end{aligned}$$



Minimum charge Rs.3960 at the rate of Rs.71 per unit

$$\begin{aligned}\therefore \text{Total tariff} &= \text{Rs.}3960 + 67 \times \text{Rs.}71 \\ &= \text{Rs. } 8717\end{aligned}$$

$$\begin{aligned}50 \% \text{ tariff for sewerage service} &= 50 \% \text{ of Rs.}8,717 \\ &= \frac{50}{100} \times \text{Rs. } 8717 \\ &= \text{Rs. } \frac{8717}{2} \\ &= \text{Rs. } 4358.50\end{aligned}$$

$$\begin{aligned}\therefore \text{Total amount of bill} &= \text{Rs. } 8,717 + \text{Rs. } 4,358.50 \\ &= \text{Rs. } 13,075.50\end{aligned}$$

If the bill is paid within the fourth month of distribution, an additional 10 % charge or fine or penalty has to be paid.

$$\begin{aligned}\text{So, fine amount} &= 10 \% \text{ of Rs. } 13,075.50 \\ &= \frac{10}{100} \times 13,075.50 \\ &= \text{Rs. } 1,307.55\end{aligned}$$

Exercise 4.2

1. **There is $\frac{1}{2}$ inch drinking water supply pipe is connected in Kopila's house. The current and previous reading in the month of Shrawan are 4225 and 4197 respectively. Solve the following questions on the basis of tariff table given on the previous page:**
- (a) How much does Kopila have to pay for 50% of that month's sewage service?
 - (b) What is the total bill amount?
 - (c) If the bill is paid within the first and second month of distribution, how much tariff will Kopila have to pay?
 - (d) If the bill is paid within the third month of distribution, how much tariff will she have to pay?
2. **423 unit of water was consumed in a month at a hotel from a 1.5" sized water supply pipe. Solve the following questions on the basis of tariff table given on the previous page:**
- (a) What will be the total tariff including sewerage in that month?
 - (b) If the bill is paid within five months of the distribution of the bill, how much penalty has to be paid?

Answers

- | | | | | |
|----|----------------|-------------------|----------------|---------------|
| 1. | (a) Rs. 338 | (b) Rs. 1,014 | (c) Rs. 983.58 | (d) Rs. 1,014 |
| 2. | (a) Rs. 44,967 | (b) Rs. 53,960.40 | | |

4.3 Household expenses for use of telephone

Activity 1

Study the given bill and answer the following questions:

नेपाल टेलिकम Nepal Telecom (Nepal Doorsanchar Company Limited)		TAX INVOICE		TPIN/PAN : 300044614	
Transaction No	73414226817	Invoice No	R210623414226817	Date (BS AD)	12078-03-9 25-Jun-2021 11:57 AM
Customer Company's Name	Hedge Account No	6001190372	Customer's TPIN/PIN	1
Subscription Number s	015531957	Payment Type	PAYMENT/ADVANCE PAYMENT	Subscription Type	PSTN
				Payment Mode	Cash
Bill of	Baisakh Jestha of 2078 Chaitra of 2077				
Charge Items	Charge(NPR)	TSC(NPR)	VAT(NPR)		
Bill Amount	404.01	52.52	59.34		
Fine	7.21	0.00	0.00		
Maintenance	0.00	0.00	0.00		
Rebate	0.0	0.00	0.00		
Adjustment	0.00	0.00	0.00		
Advance	1.92	0.00	0.00		
OT	0.00	0.00	0.00		
Sum Amount	413.14	52.52	59.34		
Invoice Amount	525.00				
IPTV Cash Received	0.00				
Total Receivable Amount	525.00				
Tender Amount : Rs	525.00	Return Amount : Rs	0.00	Total Received : Rs	525.00
Received Amount(In words)	Five Hundred And Twenty Five Rupees Only				
Counter	Thecho	Received By	No. Of Copy	1[Original]
Note: In case of Deposit and Advance Payment, this invoice is considered as Receipt as well. IPTV Tax invoice is provided by NT Partner's Billing System					

- What details are mentioned in the bill?
- What is the amount of value added tax in the bill?
- What is the total tariff?

The above bill is related to local call tariff. On the basis of rule of local call, tariff of minimum 175 calls is Rs.200, After that, tariff is calculated by adding Re. 1 per call extra amount. Costumer has to pay 10 % service charge (for service provider company) of the tariff of total calls. 13 % value added tax amount of total tariff with service charge should be deposited to Nepal Government as a revenue.

So, the total tariff (TC) = minimum tariff + extra tariff

Service charge (TSC) = 13 % of total tariff

Value added tax (VAT) amount = 13 % of (TC + TSC)

Total tariff = TC + TSC + VAT amount

Tariff Rate of GSM Prepaid of Nepal Telecom

S.N.	Types of Service	Charge
1.	On-Net call	Rs.1.50 per minute
	Off-Net call	Rs.2 per minute
2.	SMS service	Rs.1 per SMS (in network of telecom)
		Rs.1.25 per SMS (in other networks)
		Rs.5 per SMS (for international SMS)
3.	Friends and family service (FNF service)	Rs.0.70 per minute for maximum 5 persons
4.	Video call charge	Rs.2 per minute

Tariff Rate of GSM Postpaid of Nepal Telecom

S.N.	S.N.	Peak hour 6:00 AM - 18:00 PM	Off peak hour 10:00 PM - 6:00 AM	Monthly rental charge
1.	On-net call	Re. 1 per minute	Re. 0.55 per minute	Rs. 300
	Off-net call	Re. 1.5 per minute	Re. 1.5 per minute	
2.	Short message service (SMS)	Re.1 per SMS (on - net sms)		
		Rs. 5 per international SMS		
3.	FNF Service	Rs.0.55 per minute for maximum 6 person		
4.	Video call charge	Rs. 2 per minute		

Note:

1. Tax is not included in the above tariff rate.
2. 13 % telecom service charge and 13 % value added tax are charged on the tariff. (Applicable from Shrawan-1, 2075)

3. 2 % ownership tax (OT) is charged on the total tariff including 13% telecom service charge and 13 % value added tax.
4. Detail information is in the website www.ntc.net.np of Nepal Telecom.

General Notice:

Please pay your bills on time to avoid call restriction by Credit Control System.

To know due amount and available credit limit, please type CB for GSM/CDMA Postpaid and send sms to 1415, CB*PSTN Number and send sms to 1545.

13% TSC & 13% VAT will be applied as per Government rule from 1st Shrawan 2075.

GSM/CDMA Outgoing calls will be blocked (1-Way bar) after finishing remaining credit limit. Outgoing and incoming both calls will be blocked (2-Way bar) on crossing 90 days of 1-way bar.

Both Outgoing and Incoming calls will be blocked (2-Way bar)) automatically in PSTN after finishing remaining credit limit.

For PSTN Numbers distributed from Soft Switches like NGN, IMS MSAN, MSAG: Meter reading value remains same in each month bill statement; local calls are charged based on call data record (CDR), not on meter reading.

To download monthly Bill statement, please visit: <http://gsmb1.ntc.net.np/>
For any complaints, Please contact nearest customer care center or dial 191.1498.

2% Ownership Tax (OT) will be applied on every GSM and CDMA Postpaid mobile recharge as per Government rule from 1st Shrawan 2077.

Example 1

If there is 267 call in a month from PSTN telephone line,

- Find the total charge (TC) of that month.
- Calculate the service charge (TSC) and value added tax (VAT).
- What is the total telephone tariff of that month?

Solution,

Here, the total telephone call of one month is 267.

And minimum charge of 175 call = Rs.200

$$\begin{aligned}\text{Now, 267 call} &= 175 \text{ call} + (267 - 175) \text{ call} \\ &= 175 \text{ call} + 92 \text{ call}\end{aligned}$$

Minimum charge Rs. 200 at the rate of Re.1 per call

$$\begin{aligned}\therefore \text{Total tariff (TC)} &= \text{Rs. } 200 + 92 \times \text{Re.1} = \text{Rs. } 200 + \text{Rs. } 92 \\ &= \text{Rs. } 200 + \text{Rs. } 92 \\ &= \text{Rs. } 292\end{aligned}$$

Service charge (TSC) = 13% of Rs. 292

$$\begin{aligned}&= \frac{13}{100} \times \text{Rs. } 292 \\ &= \text{Rs. } 37.96\end{aligned}$$

$$\begin{aligned}\text{Total tariff including (C + TSC) including service charge (TSC)} &= \text{Rs. } 292 + \text{Rs. } 37.96 \\ &= \text{Rs. } 329.96\end{aligned}$$

Now, value added tax amount = 13 % of Rs.329.96

$$\begin{aligned}&= \frac{13}{100} \times \text{Rs. } 329.96 \\ &= \text{Rs. } 42.89\end{aligned}$$

$$\begin{aligned}\text{(c) Total tariff} &= \text{C} + \text{TSC} + \text{VAT amount} \\ &= 292 + 37.96 + 42.89 \\ &= \text{Rs. } 372.85\end{aligned}$$

\therefore The total telephone tariff of that month = Rs. 372.85

Alternative Method,

Total call = 267 call

Extra call = $267 - 175 = 92$ call

$$\begin{aligned}\text{Total tariff (TC)} &= \text{minimum charge} + \text{extra charge} \\ &= \text{Rs. } 200 + \text{Rs. } 92 \times 1 \\ &= \text{Rs. } 292\end{aligned}$$

$$\begin{aligned}\text{Tariff including TSC and VAT} &= 113\% \times 113\% \times \text{TC} \\ &= \frac{113}{100} \times \frac{113}{100} \times 292 \\ &= \text{Rs. } 372.85\end{aligned}$$

Example 2

Under GSM prepaid mobile service of Nepal Telecom, when recharging from a recharge card of Rs.100, how much rupees of talk time (voice call) can be used by the concerned customer? 13 % telecom service charge (TSC), 13 % value added tax and 2% ownership tax (OT) are included in that Rs.100. If the rate of voice call charge within NT Network is Rs.1.50 per minute, how many minutes can be talked? Find out.

Solution,

Telecom service charge (TSC) = 13%

Value added tax (VAT) = 13%

Ownership tax (OT) = 2%

Recharge amount = Rs.100

Let, the price before adding OT = Rs. x

$$\therefore x + 2\% \text{ of } x = \text{Rs. } 100$$

$$\text{or, } x + \frac{2}{100} \times \text{Rs. } x = 100$$

$$\text{or, } \frac{102x}{100} = 100$$

$$\therefore x = 98.04$$

Again, let the price before applying 13 % VAT = Rs. y

$$\therefore y + 13\% \text{ of } y = 98.04$$

$$\text{or, } y + y \times \frac{13}{100} = 98.04$$

$$\text{or, } \frac{113y}{100} = 98.04$$

$$\therefore y = 86.76$$

Similarly,

Let the price before adding TSC = Rs. z

$$\therefore z + 13\% \text{ of } z = \text{Rs. } 86.76$$

$$\text{or, } z + z \times \frac{13}{100} = 86.76$$

$$\text{or, } \frac{113z}{100} = 86.76$$

$$\therefore z = 76.78$$

\therefore While recharging of Rs.100, talk time equal to Rs.76.78 can be used.

There is a charge of Rs.1.50 per minute for making phone calls and talking within the network of Nepal Telecom.

$$\begin{aligned} \therefore \text{Time to talk for Rs.76.78} &= \frac{76.78}{1.50} \text{ minute} \\ &= 51.19 \text{ minute} \end{aligned}$$

\therefore By using the recharge card of Rs.100, we can talk for 51.10 minutes in phone call within the network of Nepal Telecom.

Exercise 4.3

1. The current reading telephone calls of Ramlal's house in the month of Baishakh is 4444 and previous reading is 3992, calculate:

- How many total calls have been made?
- What is the total tariff (TC) of the calls if Rs.200 is charged for first 175 calls and after that Re. 1 per call?
- Calculate service charge and value added tax amount.
- Calculate the total tariff after adding value added tax.

2. Calculate the total tariff including 13% service charge (TSC) and 13% value added tax for the following telephone calls: (Where Rs.200 is charged for first 175 calls and after that Re. 1 per call is added)

- (a) 550 calls (b) 695 calls (c) 793 calls

3. Minimum tariff for the first 175 calls is Rs.200 and after that Re. 1 is charged for each extra call. How many telephone calls can be made from the following amount excluding service charge (TSC) and value added tax?

- (a) Rs. 275 (b) Rs. 695 (c) Rs. 890

4. Minimum tariff for the first 175 calls is Rs.200 and after that Re. 1 is charged for each extra call. If the total tariff including 13 % service charge and 13 % value added tax is Rs.696.08, how many telephone calls had been made?
5. Minimum service charge (Rental charge) of GSM postpaid mobile service of Nepal Telecom is Rs.300. After applying 13 % service charge on this amount, 13 % value added tax is added. If after that again 2 % ownership tax is added on the total tariff, how much minimum monthly tariff has to be paid by a postpaid sim user?

Answers

- | | | | |
|------------------|-----------------|----------------------------|------------------|
| 1.(a) 452 calls | 1.(b) Rs. 477 | 1.(c) Rs. 47.70, Rs. 68.21 | 1.(d) Rs. 592.91 |
| 2.(a) Rs. 714.73 | 2.(b) Rs=894.96 | 2.(c) Rs=1016.77 | |
| 3.(a) 250 calls | 3.(b) 670 calls | 3.(c) 865 calls | |
| 4. 535 calls | 5. Rs. 390.73 | | |

4.4 Calculation of amount of taxi meter

Activity 1

Discuss the following questions:

- Have you ever used taxi to go from one place to another?
- Have you seen noticeboard about taxi fare somewhere?
- How much taxi meter is maintained by the office under the Nepal Bureau of Standards of Metrology (NBSM) at present? How and from where can we get the information about it?

Taxis used in urban areas may or may not be connected with meter. The fares of metered taxis are uniform and the chances of fraud are also very low. Complaints can be lodged with the nearest Traffic Police Office along with the taxi number in case of any inconvenience related to taxi fare and fraud.

The rates of fare mentioned here may change over a period of time.

The taxi fare rate posted on the website of the Nepal Bureau of Standards of Metrology are mentioned in the following table:

From 6.00 am to 9.00 pm	From 9 pm to 6 am
Initial rate: Rs.14	Initial rate: Rs.21
Per 200 meter: calculated at the rate of Rs.7.80 per km adding Rs.39, fare of initial 1km: Rs.53	Per 200 meter: calculated at the rate of Rs.11.70 per km adding Rs.58.50, fare of initial 1km: Rs.79.50
Additional fare rate per kilometer: Rs.39	Additional fare rate per kilometer: Rs.58.50
Waiting charge: Rs.7.80 per 2 minute	Waiting charge: Rs.11.70 per 2 minute

Example 1

Bimakumari took a taxi to travel 6 km from Balkhu to Putalisadak in Kathmandu. Initially the taxi meter charged a minimum of Rs.14 and then Rs. 7.80 per 200 meters. During the journey, if 10 minutes waiting charge at the rate of Rs.7.80 per 2 minute was also charged, how much taxi fare did she pay? Find it.

Solution,

Minimum (initial) charge = Rs. 14

The distance travelled by the taxi = 6 km
= 6×1000 m
= 6000 m

Here, the fare of 200 m = Rs.7.80

Fare of 1 m = $\frac{7.80}{200}$

Fare of 6000 m = $\frac{7.80}{200} \times 6000$ = Rs. 234

The amount for waiting charge = $\frac{7.80}{2} \times 10$
= Rs. 39

The total fare paid by Bimakumari = $14 + 234 + 39$
= Rs. 287

Alternative Method

Minimum (initial) charge = Rs. 14

The distance travelled by the taxi = 6 km

Fare per km = Rs.39

Waiting time = 10 minutes

The amount for waiting charge per 2 minutes = Rs.7.80

The amount for waiting charge for 10 minutes = $\frac{\text{Rs. } 7.80}{2} \times 10$ = Rs. 39

Total fare = Rs. $14 + 39 \times 6 + 39$
= Rs. $14 + 234 + 39$
= Rs. 287

Exercise 4.4

1. Shreenath took a taxi to travel 9 km from Baneshwar to Bhaktapur. Initially the taxi meter charged a minimum of Rs.14 and then Rs. 7.80 per 200 meters. During the journey, if 6 minutes waiting charge at the rate of Rs. 7.80 per 2 minute was also charged, how much taxi fare did he pay? Find it.
2. Shristi took a taxi to travel 18 km from Jagati, Bhaktapur to Sanepa, Lalitpur. At first, the taxi meter charged a minimum of Rs.14 and then Rs. 7.80 per 200 meters. During the journey, if 20 minutes waiting charge at the rate of Rs. 7.80 per 2 minute was also charged, how much taxi fare did he pay? Find it.
3. **Calculate the taxi fare in the following cases based on the rate mentioned in this lesson:**

Distance (in km)	Time	Waiting time (in minute)
(a) 6	8 am	15
(b) 15	3:30 pm	10
(c) 7.5	11 pm	-
(d) 8.75	4 am	7

4. Samyog pays Rs.228.50 for taking a taxi with 10 minutes of waiting charge. Taxi meter shows the fare at first, a minimum of Rs.14 and then Rs.7.80 per 200 meters. If the waiting charge is at the rate of Rs.7.80 per 2 minutes, what distance does he travel?
5. Phulmaya payed Rs.1027.20 for taking a taxi including 12 minutes of waiting charge. She had to pay Rs 14 at first, and then Rs.11.70 per 200 meters. If the waiting charge was at the rate of Rs.11.70 per 2 minutes, what distance did she travel?

Project Work

Take a recharge card of Rs.100 of prepaid mobile. Calculate service charge, amount of value added tax mentioned in that card and present in your classroom.

Answers

- | | | | |
|-------------------|-------------------|-------------------|---------------|
| 1. Rs. 388.40 | 2. Rs.794 | 3. (a) Rs. 306.50 | 3.(b) Rs. 638 |
| 3. (c) Rs. 459.75 | 3. (d) Rs. 573.83 | 4. 4.5 km | 5. 16 km |

Miscellaneous Exercise

1. A person earning Rs.7 lakhs per annum has to pay income tax depending on the number of dependent families as 1 % up to Rs.4,50,000 and 10 % on the remaining income. How much income tax does he or she have to pay?
2. A person who earns Rs.4,60,000 per annum, has to pay Rs. 5,600 income tax. If the rate of tax is 1% up to Rs.4,50,000, then what is its rate for remaining amount? Find it.
3. If an organization has to pay the income tax at the rate of 2.5 % on its income up to Rs.10 lakhs, 4 % on the income above Rs.10 lakhs and up to Rs. 20 lakhs, 5. 25 % on the income above Rs. 20 lakhs and up to 40 lakhs and 12.75 % on the income above 40 lakhs, calculate the tax amount for the following yearly income:
(a) Rs. 7,60,000 (b) Rs. 15,70,500 (c) Rs. 23,75,600 (d) Rs. 55,75,000
4. What is the simple interest of Rs.50,000 in 1 year at the rate of 2 paisa per Rs. 3 per month? If 5 % tax is levied on that interest, what is the net amount of simple interest?
5. **A shopkeeper bought a bicycle for Rs.7,520 and sold it at a marked price of Rs. 10,000. If the rate of value added tax is 13 %,**
 - (a) How much does the costumer have to pay?
 - (b) What is the percentage of profit made by the shopkeeper in this transaction?
 - (c) If it had sold at a discount of 30 % on the marked price, what would be its value including value added tax?
6. A laptop was bought at Rs.1,50,000 and sold at a profit of 10 %, what would be its value with 13 % value added tax?
7. If an item is sold at Rs.9040 with 20 % discount and 13 % value added tax, how much discount amount is given? Find.
8. A dealer has bought a computer from an importer at Rs.2,600 including value added tax. The dealer adds the transportation charge and profit then sells it to a retailer at Rs.25,990 including value added tax. If the rate of value added tax is 13%, calculate the following:
 - (a) At what price did the dealer buy from the importer excluding value added tax?
 - (b) What was the profit of the retailer?
 - (c) How much amount of value added tax was deposited to government account?
 - (d) How much amount of value added tax should be deposited by the retailer to the governments account?

9. The monthly salary of a sales manager is Rs. 22,000 and 0.75% commission of total sales is added to his salary. If the sales of a month is Rs.6,24,000, what will be his total income? How much percentage of income is added to his monthly salary?
10. A house owner gives 3 % commission of rent amount to an agent for renting his house. If the total monthly rent of the house is Rs. 75,000, how much amount does the agent receive in a year?
11. Rohan receives Rs.1 corer, 28 lakhs and 25 thousand by selling his house after giving 5% commission to the agent, what was the selling price of his house? Find it.
12. 25 % of the profit of a company is Rs.1,50,000. The company has decided to distribute a bonus of 65 % of the total profits equally to its 15 employees as an incentive, how much bonus does each employee receive?
13. If a bank has decided to distribute 55 % bonus of its profits in a year to its 275 employees at the rate of Rs.65000 each, what was the total profit of the bank?
14. Out of 3,50,000 shares of a cement manufacturing company worth Rs.100, Hari bahadur has 250 shares of IPO. If the company decides to pay 40 % cash dividend in case of annual profit of Rs.9,00,00,000, how much dividend will the shareholder Hari bahadur get in total?
15. A meter of capacity 5 ampere capacity is connected in a house. The meter reading of that house from Baishakh to Ashoj are given in the following table:

Month	Baishakh	Jestha	Ashar	Shrawan	Bhadra	Ashoj
Meter Reading	1577	1622	1647	1662	1689	1731

From the above table, if the meter was read on the last day of each month, calculate the electricity tariff based on the current rate:

- (a) How many units of electricity have been consumed from the month of Jestha to Ashoj?
- (b) Which month's bill has the highest electricity tariff and how much?
- (c) Which month's bill has the lowest electricity tariff and how much?
- (d) How much is to be paid if the tariff for the month of Jestha is paid on 13th of Ashar?

- (e) How much total tariff is to be paid if the tariff for the month of Ashar is paid on 27th of Shrawan?
- (f) How much amount is required if the tariff for the month of Ashoj is paid on 5th of Kartik?
16. A hotel consumes 58,000 liter of water connected through a pipe of size $\frac{3}{4}$ inch. How much tariff should be paid if it is paid within the fourth month from the bill distribution date. Find out the tariff with 50 % sewage service.
17. If Rs.200 is charged for first 175 calls and after that Re. 1 per call is added, calculate the total tariff including 10% telecom service charge (TSC) and 13% value added tax for the following telephone calls:
- (a) 275 calls (b) 325 calls (c) 469 calls
18. If it is calculated Rs.200 for first 175 calls and after that Re. 1 per call is added, find the total calls for the following total tariff including 10% telecom service charge (TSC) and 13% value added tax:
- (a) Rs. 766.14 (b) Rs. 893.83 (c) Rs. 1021.52 (d) Rs. 1149.21
19. At first, the taxi meter shows a minimum of Rs.14 and then Rs. 7.80 per 200 meters, calculate the fare of taxi for the following distance to be travelled:
- (a) 4 km (b) 9 km (c) 13 km (d) 15 km

Answers

1. Rs. 42,000
2. 10%
3. (a) Rs. 19,000
3. (b) Rs. 47,820
3. (c) Rs. 84,719
3. (d) Rs. 3,70,812.50
4. Rs. 4,000 and Rs. 3,800
5. (a) Rs. 1,13,00
5. (b) 32.98%
5. (c) Rs. 7,910
5. (d) Loss 6.91%
6. Rs. 1,86,450
7. Rs. 2,000
8. (a) Rs. 20,000
- (b) Rs. 2,000
- (c) Rs. 3,250
- (d) Rs. 260
9. Rs. 2,66,680 and 0.21%
10. Rs. 27000
11. Rs. 1,21,83,750
12. Rs. 26,000
13. Rs. 3,25,00,000
14. Rs. 25,714.29
15. (a) Jestha 45 units, Ashar 25 units, Shrawan 15 units, Bhadra 27 units, Ashoj 42 units
- (b) Jestha, Rs. 332.50
- (c) Shrawan, Rs. 75
- (d) Rs. 332.50 as per bill
- (d) Rs. 152.25
- (f) Rs. 300.86
16. Rs. 6,783.15
17. (a) Rs. 383.07
- (b) Rs. 446.92
- (c) Rs. 630.79
18. (a) 575 calls
- (b) 675 calls
- (c) 775 calls
- (d) 875 calls
19. (a) Rs. 170
- (b) Rs. 365
- (c) Rs. 521
- (d) Rs. 599

5.0 Review

Be divided into appropriate number of groups. Draw a triangle in each group, measure the sides. What type of triangle is formed? Discuss and present in the class.

- If all three sides of triangle are equal, then it is called an equilateral triangle.
- If any two sides of triangle are equal, then it is called an isosceles triangle.
- If the measures of all three sides are different, then it is called scalene triangle.

5.1 Area of scalene triangle

Activity 1

Study the given triangle and discuss:

Let, ABC be a triangle, in which, side BC = a unit, CA = b unit and AB = c unit. Perpendicular AD is drawn from the vertex A to the base BC, i.e, $AD \perp BC$. In the base side Bc, if we suppose DC by x unit then BD will be $(a - x)$ unit. Let the height of the triangle ABC be $AD = h$ unit.

Now, the perimeter of the triangle ABC (P) = $a + b + c$ and its semi-perimeter (s)

$$\text{becomes } (s) = \frac{P}{2} = \frac{a + b + c}{2}$$

Here, in the right angled triangle ADB,

$$AD^2 + BD^2 = AB^2$$

$$\text{or, } h^2 + (a - x)^2 = c^2$$

$$\text{or, } h^2 = c^2 - (a - x)^2 \dots\dots\dots (i)$$

Again in the right angled triangle ADC

$$AD^2 + DC^2 = AC^2$$

$$\text{or, } h^2 + x^2 = b^2$$

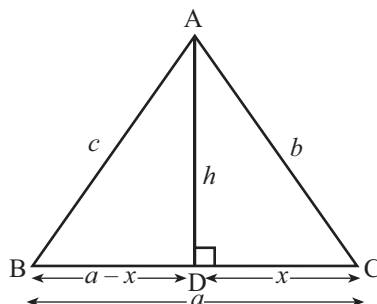

$$\text{or, } h^2 = b^2 - x^2 \dots\dots\dots \text{(ii)}$$

From equation (i) and (ii)

$$c^2 - (a - x)^2 = b^2 - x^2$$

$$\text{or, } c^2 = b^2 - x^2 + (a - x)^2$$

$$\text{or, } c^2 = b^2 - x^2 + a^2 - 2ax + x^2$$

$$\text{or, } c^2 = b^2 + a^2 - 2ax$$

$$\text{or, } 2ax = b^2 + a^2 - c^2$$

$$\text{or, } x = \frac{b^2 + a^2 - c^2}{2a} \dots\dots\dots \text{(iii)}$$

Substituting the value of x in equation (ii),

$$h^2 = b^2 - \left(\frac{b^2 + a^2 - c^2}{2a}\right)^2$$

$$\text{or, } h^2 = b^2 - \frac{(b^2 + a^2 - c^2)^2}{4a^2}$$

$$\text{or, } h^2 = \frac{4a^2b^2 - (a^2 + b^2 - c^2)^2}{4a^2}$$

$$\text{or, } h^2 = \frac{(2ab)^2 - (a^2 + b^2 - c^2)^2}{4a^2}$$

$$\text{or, } h^2 = \frac{(2ab + a^2 + b^2 - c^2)(2ab - a^2 - b^2 + c^2)}{4a^2}$$

$$\text{or, } h^2 = \frac{[(a + b)^2 - c^2][c^2 - (a - b)^2]}{4a^2}$$

$$\text{or, } h^2 = \frac{(a + b + c)(a + b - c)(c + a - b)(c - a + b)}{4a^2} \dots\dots\dots \text{(iv)}$$

From above, $s = \frac{a + b + c}{2}$

$$\text{or, } a + b + c = 2s \dots\dots\dots \text{(v)}$$

$$\text{or, } a + b = 2s - c$$

Subtracting c from both sides

$$\text{or, } a + b - c = 2s - c - c$$

$$\text{or, } a + b - c = 2s - 2c = 2(s - c)$$

$$\therefore a + b - c = 2(s - c) \dots\dots\dots \text{(vi)}$$

Similarly, $a + c - b = 2s - 2b = 2(s - b) \dots\dots\dots \text{(vii)}$

$$b + c - a = 2s - 2a = 2(s - a) \dots\dots\dots \text{(viii)}$$

from equations (iv), (v), (vi), (vii) and (viii),

$$h^2 = \frac{2s \times 2(s-c) \times 2(s-b) \times 2(s-a)}{4a^2}$$

or,
$$h^2 = \frac{16s(s-a)(s-b)(s-c)}{4a^2}$$

or,
$$h = \frac{2\sqrt{s(s-a)(s-b)(s-c)}}{a}$$

we know that,

$$\text{Area of triangle ABC} = \frac{1}{2} \times \text{BC} \times \text{AD} = \frac{1}{2} \times a \times h$$

$$= \frac{1}{2} \times a \times \frac{2\sqrt{s(s-a)(s-b)(s-c)}}{a}$$

$$= \sqrt{s(s-a)(s-b)(s-c)}$$

$$\therefore \text{Area of triangle ABC} = \sqrt{s(s-a)(s-b)(s-c)} \text{ square units}$$

Formula to find the area of scalene triangle,

Area of scalene triangle = $\sqrt{s(s-a)(s-b)(s-c)}$, where s is the semi perimeter of the triangle. It is called Heron's formula

Example 1

If the length of edges of a triangular field are 5m, 12m and 13m, find its area:

Solution,

Here,

Let $a = 5$ m, $b = 12$ m and $c = 13$ m

$$\text{Semi-perimeter } (s) = \frac{a+b+c}{2} = \frac{5+12+13}{2} \text{ m} = 15 \text{ m}$$

According to the formula,

$$\begin{aligned} \text{Area of triangle} &= \sqrt{s(s-a)(s-b)(s-c)} \\ &= \sqrt{15(15-5)(15-12)(15-13)} \text{ m}^2 \\ &= \sqrt{15 \times 10 \times 3 \times 2} \text{ m}^2 \\ &= \sqrt{900} \text{ m}^2 \\ &= 30 \text{ m}^2 \end{aligned}$$

Example 2

Find the area of the given quadrilateral:

Solution,

Here,

there are two scalene triangles in the given quadrilateral.

In, $\triangle ABC$, $AB = c = 16$ cm, $BC = a = 12$ cm, $AC = b = 20$ cm

$$\text{Semi-perimeter } (s) = \frac{a + b + c}{2} = \frac{12 + 20 + 16}{2} = 24 \text{ cm}$$

According to the formula,

$$\begin{aligned} \text{Area of } \triangle ABC (A_1) &= \sqrt{s(s-a)(s-b)(s-c)} \\ &= \sqrt{24(24-12)((24-20)(24-16)} \\ &= \sqrt{24 \times 12 \times 4 \times 8} \\ &= \sqrt{9216} \\ &= 96 \text{ cm}^2 \end{aligned}$$

Again in $\triangle ACD$,

Let $AD = a = 14$ cm, $CD = b = 10$ cm and $AC = c = 20$ cm

$$\text{Semi-perimeter } (s) = \frac{a + b + c}{2} = \frac{14 + 10 + 20}{2} = \frac{44}{2} = 22 \text{ cm}$$

$$\begin{aligned} \text{Area of } \triangle ACD (A_2) &= \sqrt{s(s-a)(s-b)(s-c)} \\ &= \sqrt{22(22-14)((22-10)(22-20)} \\ &= \sqrt{22 \times 8 \times 12 \times 2} \\ &= \sqrt{4224} \\ &= 8\sqrt{66} \text{ cm}^2 \end{aligned}$$

$$\begin{aligned} \therefore \text{Area of the quadrilateral } ABCD &= A_1 + A_2 \\ &= (96 + 8\sqrt{66}) \text{ cm}^2 \\ &= 160.99 \text{ cm}^2 \end{aligned}$$

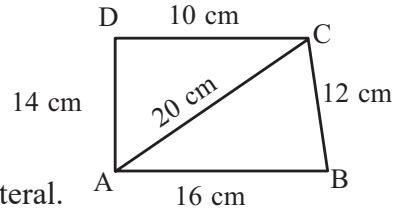

Example 3

If the edges of a triangular kitchen garden are in the ratio 3: 4: 5 and area 216 square meter, what will be the perimeter of that kitchen garden? Find out.

Solution,

Here let the length of edges of the kitchen garden be

$$a = 3x \text{ m } b = 4x \text{ m and } c = 5x \text{ m}$$

$$\text{Now, Semi-perimeter } (s) = \frac{a + b + c}{2} = \frac{3x + 4x + 5x}{2} = 6x \text{ m}$$

$$\text{Area of kitchen garden } (A) = 216 \text{ m}^2$$

According to the formula,

$$\text{Area of the kitchen garden } (A) = \sqrt{s(s-a)(s-b)(s-c)}$$

$$216 = \sqrt{6x(6x-3x)(6x-4x)(6x-5x)}$$

$$\text{or, } 216 = \sqrt{6x \times 3x \times 2x \times x}$$

$$\text{or, } 216 = \sqrt{36x^4}$$

$$\text{or, } 216 = 6x^2$$

$$\text{or, } \frac{216}{6} = x^2$$

$$\therefore x = 6$$

Thus the length of the edges of the kitchen garden,

$$a = 3x = 3 \times 6 = 18 \text{ m}$$

$$b = 4x = 4 \times 6 = 24 \text{ m}$$

$$c = 5x = 5 \times 6 = 30 \text{ m}$$

Again, perimeter of kitchen garden (P) = $a + b + c$

$$= (18 + 24 + 30) \text{ m}$$

$$= 72 \text{ m}$$

Example 4

The area and perimeter of a triangular park having length 26 m are 336m² and 84 m respectively. Find the length of remaining edges of that park.

Solution,

Here, area of the triangular park (A) = 336 m²

$$\text{Perimeter (P)} = 84 \text{ m}$$

$$\text{Length of one edge (a)} = 26 \text{ m}$$

$$\text{Remaining two edges (b)} = ? \text{ and } c = ?$$

$$\text{Now, semi-perimeter (S)} = \frac{P}{2} = \frac{84}{2} = 42 \text{ m}$$

We know that,

$$P = a + b + c$$

$$84 = 26 + b + c$$

$$\text{or, } b + c = (84 - 26)$$

$$\text{or, } b + c = 58$$

$$b = (58 - c) \dots\dots\dots (i)$$

$$\text{Area of park (A)} = \sqrt{s(s-a)(s-b)(s-c)}$$

$$336 = \sqrt{42(42-26)(42-58+c)(42-c)} \quad [\because \text{from equations (i)}]$$

$$\text{or, } 336 = \sqrt{42 \times 16 (c-16)(42-c)}$$

$$\text{or, } 336 = \sqrt{672 (42x - c^2 - 672 + 16c)}$$

Squaring on both sides,

$$\text{or, } (336)^2 = 672 (-c^2 + 58c - 672)$$

$$\text{or, } \frac{112896}{672} = -c^2 + 58c - 672$$

$$\text{or, } 168 + c^2 - 58c + 672 = 0$$

$$\text{or, } c^2 - 58c + 840 = 0$$

$$\text{or, } c^2 - (30 + 28)c + 840 = 0$$

$$\text{or, } c^2 - 30c - 28c + 840 = 0$$

$$\text{or, } c(c - 30) - 28(c - 30) = 0$$

$$\text{or, } (c - 30)(c - 28) = 0$$

or, $c - 30 = 0 \Rightarrow c = 30$ m

or, $c - 28 = 0 \Rightarrow c = 28$ m

(a) when substituting $c = 30$ m in equation (i)

$$b = (58 \text{ m} - 30 \text{ m}) = 28 \text{ m}$$

(b) When substituting $c = 28$ m in equation (i)

$$b = 58 \text{ m} - 28 \text{ m} = 30 \text{ m}$$

\therefore Length of remaining edges are 28 m and 30 m.

Exercise 5.1

1. Answer the given questions:

- What is meant by scalene triangle?
- If the length of three sides of a triangle are p cm, q cm and r cm respectively, what is the perimeter of the triangle?
- Write the formula to find the area of scalene triangle (Heron's formula).

2. Find the area of the given scalene triangles.

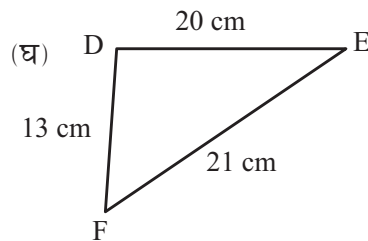
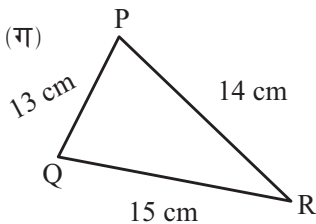
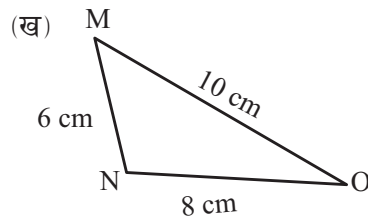
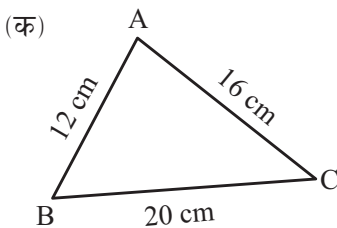

3. Find the area of the given quadrilateral:

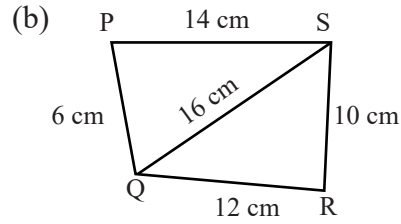
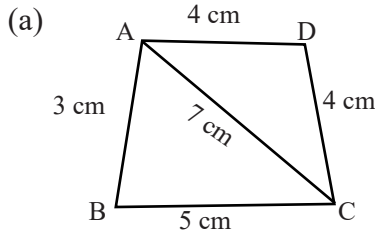

- The edges of a triangular field are in the ratio of 3: 5: 7 and its perimeter is 300m. What is the area of that field? Find out.
- The edges of a triangular field are in the ratio of 12: 17: 25 and its perimeter is 540 ft. What is the area of that field? Find out.
- The edges of a triangular garden are in the ratio $\frac{1}{2} : \frac{1}{3} : \frac{1}{5}$ and its perimeter is 62m. What is the area of that field? Find out.
- Area of a triangular field having perimeter 20 m and measure of one side 9m is $6\sqrt{5}$ m², find the measure of remaining edges of that field.

- The given traffic symbol board is of equilateral triangular shape having length of sides 'a' cm. If the perimeter of the board is 360 cm, find its area using Heron's formula.

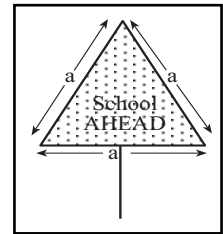

- The given figure is the scale drawing of a quadrilateral land. The land will have to be divided for two brothers as shown in the figure. Compare whose land is more by area. Also, find out the area of that land before dividing it.

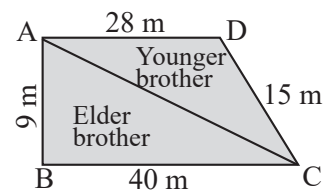

- There is a garden ABCD made in quadrilateral shape, in which $\angle C = 90^\circ$, $AB = 9$ m, $BC = 12$ m, $CD = 5$ m and $AD = 8$ m. Find the area occupied by the garden.
- Area of triangle and parallelogram having same base are equal. Length of sides of triangle are 26cm, 28cm and 30 cm. If the length of base of that parallelogram is 28 cm then what is height? Find out.

Project Work

- (a) Make a triangular shape by cutting a cardboard or a strong carton box. Measure the length of its sides using a ruler and note down on your copy. Then, find the area of that triangle by using Heron's formula and present in the class.
- (b) Divide the sheet of your copy into two triangles and find the area of the surface of the sheet by finding the area of triangles. Measure the length and breadth of that sheet and find the area using the formula for the area of a rectangle. Compare the area of that sheet obtained from both methods and present in the class.
- (c) Prepare sketches by taking actual measurements of the edges of the land allotted for making house around your home or school. Also take actual measurements of the edges needed to make triangular pieces and find the area of that piece of land (ghaderi).

Answers

1. Show to the teacher.
2. (a) 96 cm^2 (b) 24 cm (c) 84 cm (d) 126 cm^2
3. (a) 13.27 cm^2 (b) 101.48 cm^2
4. $2,598.07 \text{ m}^2$ 5. $9,000 \text{ ft}^2$ 6. 80.49 m^2
7. $4 \text{ m} / 7 \text{ m}$ 8. 56118.45 cm^2
9. $180 \text{ m}^2, 126 \text{ m}^2, 54 \text{ m}^2$ extra, 306 m^2 10. 65.49 m^2
11. 12 cm

5.2 Area of four walls, floor and ceiling

Activity 1



Be divided into appropriate groups. Study the given figures and present the answers of the following questions in the class:

- How many plane surfaces are there?
- Observe and discuss in groups how to find the surface area of a plane surface can be found and which surface area is equal between those areas.

Activity 2

Measure the length, breadth and height of any one of the rooms in your house. Prepare a drawing of the room with that measurement. Present in the class, then discuss in group and find the area of four walls, floor and ceiling.

Among them, the model of a room presented by one member of any group is presented here in the figure.

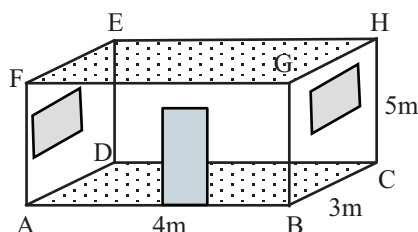

$$\text{Length of room (AB)} = l = 4 \text{ m}$$

$$\text{Breadth of room (BC)} = b = 3 \text{ m}$$

$$\text{Height of the room (HC)} = h = 5 \text{ m.}$$

Area of the floor (ABCD) of that room (A_1)

$$= AB \times BC = l \times b = 4 \times 3 = 12 \text{ }^2$$

Since the area of floor is equal to area of the ceiling,

$$\text{Area of the ceiling} = l \times b = 12 \text{ m}^2$$

Among four walls area of two walls along to its length

$$(A_2) = 2 (AB \times HC) = 2 (l \times h) = 2 (4 \times 5) = 40 \text{ m}^2$$

Area of two walls along to its breadth (A_3) = $2(BC \times HC) = 2(b \times h) = 2(3 \times 5) = 30 \text{ m}^2$

So, the area of 4 walls, floor and ceiling = $12 + 40 + 30 + 12 = 94 \text{ m}^2$

The walls on the opposite side are equal. The area of floor and ceiling is also equal.

There are four walls, one floor and one ceiling. The walls on opposite sides are equal. The area of floor and ceiling is also equal.

Area of four walls = sum of four surfaces of rectangular walls

= Area of ABGF + Area of ABGF + Area of CDEH + Area of BCHG + Area of ADEF

$$= l \times h + l \times h + b \times h + b \times h$$

$$= 2lh + 2bh$$

$$= 2h(l + b)$$

Area of floor and ceiling = Area of ABCD + Area of EFGH

$$= l \times b + l \times b = 2lb$$

Area of four walls, floor and ceiling = $2h(l + b) + 2lb$

$$= 2(hl + bh + lb)$$

$$= 2(lb + bh + hl)$$

Example 1

If the length, breadth and height of a room are 6m, 4m and 3m respectively, then,

- What is the area of the floor?
- Find the area of four walls.
- Find the area of four walls, floor and ceiling.

Solution

Here in the rectangular room,

Length (l) = 6 m

Breadth (b) = 4 m

Height (h) = 3 m

According to the formula,

$$\begin{aligned} \text{(a) Area of the floor } (A_1) &= l \times b \\ &= 6 \times 4 \text{ m}^2 \\ &= 24 \text{ m}^2 \end{aligned}$$

$$\begin{aligned} \text{(b) Area of four walls } (A_2) &= 2h(l + b) \\ &= 2 \times 3(6 + 4) \text{ m}^2 \\ &= (6 \times 10) \text{ m}^2 = 60 \text{ m}^2 \end{aligned}$$

$$\text{(c) let the area of ceiling } = (A_3)$$

We know that,

$$\text{Area of floor} = \text{area of ceiling } (A_3) = 24 \text{ m}^2$$

$$\begin{aligned} \therefore \text{Area of four walls, floor and ceiling} &= A_1 + A_2 + A_3 \\ &= (24 + 60 + 24) \text{ m}^2 \\ &= 108 \text{ m}^2 \end{aligned}$$

Alternative Method,

Area of four walls, floor and ceiling

$$\begin{aligned} &= 2(lb + bh + lh) \\ &= 2(6 \times 4 + 4 \times 3 + 6 \times 3) \\ &= 2(24 + 12 + 18) \\ &= 2 \times 54 \\ &= 108 \text{ m}^2 \end{aligned}$$

Activity 3

The length, breadth and height of a room are 10m, 8m and 3m respectively. There is a door of height 2 m and breadth 1 m and there are two windows of same shape and size with length 1 m and breadth 0.5 m.

How the area of walls without door and windows can be found, discuss in a group and present in the class.

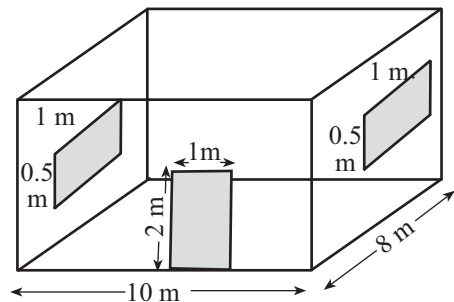

$$\begin{aligned}
 \text{Here, area of four walls with one door and two windows } (A_1) &= 2h(l + b) \\
 &= 2 \times 3(10 + 8) \\
 &= 6 \times 18 \\
 &= 108 \text{ m}^2
 \end{aligned}$$

$$\begin{aligned}
 \text{Area of the door } (A_2) &= 2 \text{ m} \times 1 \text{ m} \\
 &= 2 \text{ m}^2
 \end{aligned}$$

$$\begin{aligned}
 \text{Area of two windows having same measurement } (A_3) &= 2(1 \text{ m} \times 0.5 \text{ m}) \\
 &= 2 \times 0.5 \text{ m}^2 \\
 &= 1 \text{ m}^2
 \end{aligned}$$

$$\begin{aligned}
 \text{Now, the area of four walls without door and windows} &= A_1 - A_2 - A_3 \\
 &= (108 - 2 - 1) \text{ m}^2 \\
 &= 105 \text{ m}^2
 \end{aligned}$$

To find the area of four walls without door and window

- Find the area of four walls (A_1)
- Find the total area of windows, denote it by (A_2)
- Find the total area of doors, denote it by (A_3)
- Subtract the area of doors and windows from area of four walls

or

$$\text{The area of four walls without doors and windows } (A) = A_1 - A_2 - A_3$$

Example 2

The length, breadth and height of a room are 15 ft, 10 ft and 9 ft respectively. There are two square shaped windows having length of edges 3 ft and one door of size 6 ft. \times 3 ft. Find the area of four walls excluding windows and door.

Solution

Here,

In the rectangular room,

Length (l) = 15 ft

Breadth (b) = 10 ft

Height (h) = 9 ft

Area of four walls excluding door and windows =?

We know that,

$$\begin{aligned}\text{Area of four walls } (A_1) &= 2h(l + b) \\ &= 2 \times 9 (15 + 10) \\ &= 18 \times 25 \\ &= 450 \text{ ft}^2\end{aligned}$$

$$\begin{aligned}\text{Area of two square windows } (A_2) &= 2(l_1^2) \\ &= 2(3^2) \\ &= 2 \times 9 \\ &= 18 \text{ ft}^2\end{aligned}$$

$$\text{Area of a door } (A_3) = 6 \text{ ft} \times 3 \text{ ft} = 18 \text{ ft}^2$$

Again area of four walls excluding door and windows

$$\begin{aligned}&= \text{Area of four walls } (A_1) - \text{Area windows } (A_2) - \text{Area of door } (A_3) \\ &= (450 - 18 - 18) \text{ ft}^2 \\ &= 414 \text{ ft}^2\end{aligned}$$

Activity 4

One student has brought a model drawing of a square room made for security guard of the school. Based on that model, discuss the following questions and present in the class:

- What is the relationship between the area of the plane surfaces of the room?
- Is there any difference between the area of the floor and the area of ceiling, or not?
- What is the area of walls, floor and ceiling?
- What is the area of four walls excluding door and windows?

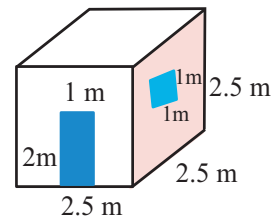

Here,

- Length, breadth and height of the room are equal, so, the areas of all plane surfaces are equal.
- In this room, length = breadth = height
 $l = b = h = 2.5 \text{ m}$
Area of the floor of the room = $l \times b = 2.5 \text{ m} \times 2.5 \text{ m} = 6.25 \text{ m}^2$

$$\text{Area of the ceiling of the room} = l \times b = 2.5 \text{ m} \times 2.5 \text{ m} = 6.25 \text{ m}^2$$

∴ The area of the floor and ceiling of the room are equal.

$$\begin{aligned} \text{(c) Area of four walls of the room including door and windows} &= 2h(l + b) \\ &= 2 \times 2.5(2.5 + 2.5) \text{ m}^2 \\ &= 5 \times 5 \text{ m}^2 \\ &= 25 \text{ m}^2 \end{aligned}$$

Now, the area of four walls, floor and ceiling

$$\begin{aligned} &= \text{Area of the floor} + \text{Area of four walls} + \text{Area of ceiling} = (6.25 + 25 + 6.25) \text{ m}^2 \\ &= 37.50 \text{ m}^2 \end{aligned}$$

$$\text{(d) Area of windows and door} = (1 \text{ m} \times 1 \text{ m} + 2 \text{ m} \times 1 \text{ m}) = 3 \text{ m}^2$$

$$\begin{aligned} \text{Now, area of four walls, floor and ceiling excluding door and windows} &= \text{Area of four walls including door and windows} - \text{Area of door and windows} \\ &= 37.50 \text{ m}^2 - 3 \text{ m}^2 \\ &= 34.50 \text{ m}^2 \end{aligned}$$

In the above presentation, area of all 6 plane surfaces are equal. Area of floor and area of each wall area also equal. Thus, it is known as cubical room.

In a room having equal length, breadth and height

- i. Area of floor = l^2
- ii. Area of four walls = $4l^2$
- iii. Area of ceiling = l^2
- iv. Area of four walls, floor and ceiling
 $= l^2 + 4l^2 + l^2 = 6l^2$
- v. If area of window is (a_1), area of door (a_2) then area of four walls, floor and ceiling excluding windows and doors = $6l^2 - a_1 - a_2$

Example 3

If the length, breadth and height of a room are 9 ft, 9 ft and 9 ft respectively, then

- Find the area of the floor.
- Find the area of four walls.
- What is the area of four walls, floor and ceiling? Find out.

Solution,

In the given cubical room, length (l) = breadth (b) = height (h) = 9 ft

Using formula,

- Area of floor (A_1) = $l^2 = (9 \text{ ft})^2 = 81 \text{ ft}^2$
- Area of four walls (A_2) = $4 l^2 = 4 \times 9 \text{ ft}^2 = 4 \times 81 \text{ ft}^2 = 324 \text{ ft}^2$
- We know that,

$$\text{Area of ceiling } (A_3) = \text{Area of floor } (A_1) = 81 \text{ ft}^2$$

$$\begin{aligned} \text{Area of four walls, floor and ceiling} &= A_1 + A_2 + A_3 \\ &= (324 + 81 + 81) \\ &= 486 \text{ ft}^2 \end{aligned}$$

Alternative Method

$$\begin{aligned} \text{Area of four walls, floor and ceiling } (A_3) &= 6 l^2 \text{ ft}^2 \\ &= 6 \times (9 \text{ ft})^2 \\ &= 6 \times 81 \text{ ft}^2 \\ &= 486 \text{ ft}^2 \end{aligned}$$

Exercise 5.2

1. Answer the following questions:

- (a) What is the relationship between the area of opposite walls of a rectangular room?
- (b) What is the relationship between the four walls of a cubical room and its relation with the area of floor?
- (c) Are the area of floor and ceiling of a rectangular room equal?
- (d) Which of the plane surfaces of a rectangular room are equal?

2. Write the name of surfaces which represents the area of floor, area of four walls and area of ceiling from the following rectangular and cubical model figures of rooms.

(a)

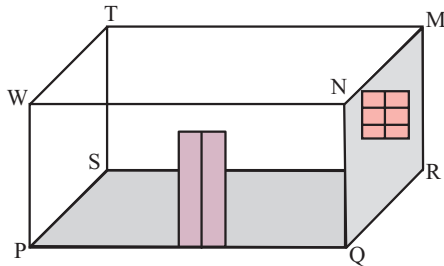

(b)

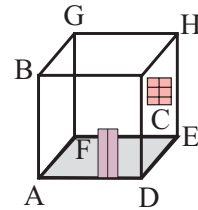

3. If the length, breadth and height of a rectangular room are 8m, 5m and 2.5 m respectively, then find (a) the area of four walls, and (b) the area of floor and ceiling.
4. **In a rectangular room of length 8.5m, breadth 6m and height 2.4m, calculate the following:**
 - (a) What is the area of floor? Find it.
 - (b) What is the area of ceiling? Find it.
 - (c) What is the area of two walls along its length? Find it.
 - (d) What is the area of two walls along its breadth? Find it.
 - (e) Find the area of four walls.
 - (f) What is the area of four walls, floor and ceiling? Find it.
5. The area of four walls of a meeting hall is 135 m^2 . If the length and breadth of the hall are 15 m and 12 m respectively, what is its height? Find it.
6. The area of four walls of a room is 432 ft^2 . If the breadth and height of the room are 14 ft and 9 ft respectively, what is its length? Find it.

7. If the perimeter of Ishan's bedroom is 60m and the area of four walls 144 m², find the height of the room.
8. **A large hall has been constructed at Sonam's school to conduct various program. Inner length, breadth and height of the hall are 30m, 25m and 4m respectively. If there are 5 windows of size 2.5m × 1.5m and 2 doors of size 5m × 3m, then**
- (a) Find the area of the floor and ceiling.
 - (b) What is the area of four walls excluding doors and windows? Find it.
 - (c) If there are 3 patterns on the ceiling per square meter, how many patterns are made in total?
 - (d) If there are three national flags per 15 square meters on the wall, find out the minimum number of flags that can be made on the wall.
9. **The length, breadth and height of a classroom are 8m, 6m and 3m respectively. If there are 2 doors of size 2m × 1.5m and 2 windows of size 1.5m × 1m, then**
- (a) What is the area of four walls excluding doors and windows? Find it.
 - (b) If the students have pasted one sheet of paper with one picture per square meter on four walls excluding doors and windows, find out how many sheets of paper are pasted on that wall.
10. **Sijan's father has rented a dark room with a single door of 2m × 1m for photo shoot. If the room is of cubical shape of side length 2.7m, then**
- (a) What is the area of four walls excluding door? Find it.
 - (b) If one photo frame is hung per 4 m² area on the four walls excluding doors and windows, find how many photo frames can be hung on that wall?

Project Work

Take a measurement of length, breadth and height of your bed room. Also take the measurement of the length and breadth of doors and windows of that room. Find the areas given in the question below and present them in the class:

- (a) Separate area of window and door
- (b) Area of four walls including doors and windows
- (c) Area of four walls excluding windows and doors
- (d) Area of four walls, floor and ceiling including doors and windows
- (e) Area of four walls, floor and ceiling excluding doors and windows
- (f) If the size of the length and breadth of your bedroom is increased by 25%, how much more will the area of four walls, floor and ceiling of that room be than the previous room? Compare.

Answers

- | | | | | |
|-----|-------------------------|--------------------------|-------------------------|--------|
| 3. | (a) 65 m^2 | (b) 80 m^2 | | |
| 4. | (a) 51 m^2 | (b) 51 m^2 | (c) 40.8 m^2 | |
| | (d) 28.8 m^2 | (e) 69.6 m^2 | (f) 171.6 m^2 | |
| 5. | 2.5 m | 6. 10 ft | 7. 2.4 m | |
| 8. | (a) 1500 m^2 | (b) 391.25 m^2 | (c) 2250 | (d) 88 |
| 9. | (a) 75 m^2 | (b) 75 | | |
| 10. | (a) 27.16 m^2 | (b) 6 | | |

5.3 Problems related to cost estimation

Activity 1

Measure your classroom length, and width in pairs and find the area to lay the carpet in your classroom. Go to a nearby carpet shop. Find out how much it costs for laying 1 square meter of carpet and find out the cost of carpet laying in your classroom and present it to the class.

For example, the work of a couple is as follows:

Length of the classroom (l) = 6 m

Breadth of the classroom (b) = 4 m

$$\begin{aligned}\text{So, the area of room (A)} &= l \times b \\ &= 6 \times 4 \text{ m}^2 \\ &= 24 \text{ m}^2\end{aligned}$$

We know that, area of the room = area of the carpet

So, the area of the carpet = 24 m^2

When asked in the shop, the rate of laying carpets in a room with ordinary carpet with wages is Rs 500 per square meter. So, the cost for laying carpet in the classroom

$$= 500 \times 24 = \text{Rs. } 12,000.$$

1. The floor area of the room = the area of the carpet.
2. The total cost for laying carpet is obtained by multiplying the cost of one square meter of carpet and the area of the carpet.

So, the total cost (T) = area of the carpet (A) \times cost of one unit of carpet (R)

Therefore, $T = A \times R$

Likewise, $R = \frac{T}{A}$ and $A = \frac{T}{R} = A \times R$

Example 1

A room is 7m long, 6m wide and 3m high. If the price of carpet per square meter is Rs 300. Find out how much it will cost to lay carpet on the floor of the room.

Solution

Here, length of the room (l) = 7 m

Breadth of the room (b) = 6 m

We know that,

$$\begin{aligned}\text{Area of the floor of the room} &= l \times b \\ &= 7 \times 6 \text{ m}^2 \\ &= 42 \text{ m}^2\end{aligned}$$

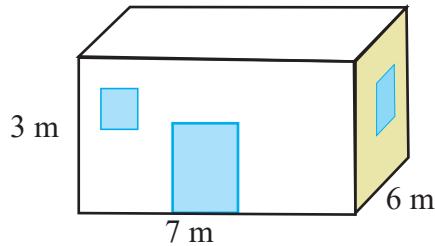

Now, the cost per square meter of carpet is Rs 300

So, total cost of 42 m² carpet = Rs. 42 × 300 = Rs. 12,600

Activity 2

Measure the length, width, and height of some of the rooms in the school by forming the appropriate number of groups. The four walls and ceiling of the room have to be painted (except doors and window). Now, find the answer to the following questions discussing in the group:

- How can the area of four walls be found?
- How can the area of four walls beside windows and doors be found?
- How can the area of ceilings be found?
- How can the total cost of painting be found?

Example 2

The length, breadth, and height of one room of Ram's house are 5m, 4m, and 3m respectively. Find out how much it costs to paint inside of all walls(except windows, doors, and ceilings) at a rate of Rs 5 per square meter.

Solution

Here,

Length of the room (l) = 5 m

Breadth of the room (b) = 4 m

Height of the room (h) = 3 m

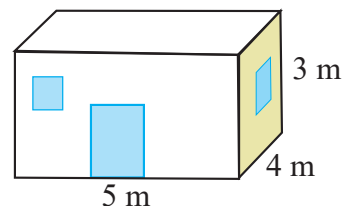

Per square meter for colouring (R) = Rs. 50

Total Cost (T) = ?

By formula,

$$\begin{aligned}\text{Area of four walls (A)} &= 2h(l + b) = 2 \times 3(5 + 4) \text{ m}^2 = 6 \times 9 \text{ m}^2 \\ &= 54 \text{ m}^2\end{aligned}$$

$$\text{Total Cost (T)} = A \times R = 54 \times 50 = \text{Rs. } 2700$$

So, Ram needs Rs. 2,700 to colour on the four walls.

Example 3

The length, width and height of a given room are 15ft, 10ft and 8ft respectively. The room has two square windows with 3ft edges and two doors of 6ft \times 2ft. Find the total cost of painting four walls and ceilings at a rate of Rs. 175.

Solution

Here,

$$\text{Length of the room (l)} = 15 \text{ ft}$$

$$\text{Breadth of the room (b)} = 10 \text{ ft}$$

$$\text{Height of the room (h)} = 8 \text{ ft}$$

Length of square window (l_1) = 3ft , height of square door (h_1) = 6 ft and width of the door (b_1) = 2ft

We know that,

$$\text{Area of the wall and ceiling of the room (A}_1) = 2h(l + b) + lb$$

$$= [2 \times 8(15 + 10) + 15 \times 10] \text{ ft}^2$$

$$= (16 \times 25 + 150) \text{ ft}^2$$

$$= (400 + 150) \text{ ft}^2$$

$$= 550 \text{ ft}^2$$

$$\text{Area of two square windows (A}_2) = 2 \times (l_1)^2$$

$$= 2 \times 3^2 \text{ ft}^2$$

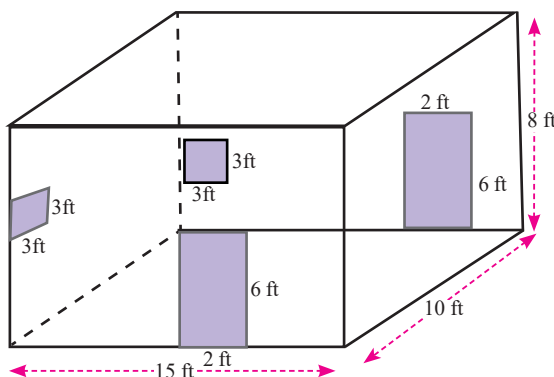

$$= 18 \text{ ft}^2$$

$$\text{Area of two doors } (A_3) = 2 (h_1 \times b_1)$$

$$= 2 \times 6 \times 2 \text{ ft}^2$$

$$= 24 \text{ ft}^2$$

The area of four walls except window and doors

$$(A) = A_1 - A_2 - A_3$$

$$= (550 - 18 - 24) \text{ ft}^2$$

$$= 508 \text{ ft}^2$$

Per square colouring cost (R) = Rs. 175

$$\text{Total cost (T)} = A \times R$$

$$= 508 \times \text{Rs. } 175$$

$$= \text{Rs. } 88,900$$

So, the total cost for colouring is Rs. 88,900.

Example 4

Laying carpets in a square meeting hall costs Rs. 10,800 at the rate of Rs. 75 per square meter. Similarly, except for the windows and doors, the cost for plastering four walls of the hall at the rate of Rs 25 per square meter costs Rs 6,000. The total area of four windows and two doors in that hall is 24m^2 , find the height of the hall.

Solution

Here,

Per square meter cost for laying carpet in the room (R_1) = Rs. 75

The total cost for laying carpet (T_1) = Rs. 10,800

Per square meter cost to plaster four walls (R_2) = Rs. 25

Total cost for plastering the four walls (T_2) = Rs. 6,000

Length of the square room (l) = ?

Height of the square room (h) = ?

Area of the floor of the square room (A_1) = $\frac{T_1}{R_1}$

$$\text{or, } l^2 = \frac{\text{Rs. } 10,800}{\text{Rs. } 75} \text{ m}^2$$

$$\text{or, } l^2 = 144 \text{ m}^2$$

$$\therefore l = 12 \text{ m}$$

$$[\because A = l^2]$$

Again, the area of the four walls except for the window and doors (A_2)

$$= \frac{T_2}{R_2}$$

$$= \frac{6,000}{25} \quad [\because A = 4hl]$$

$$= 240 \text{ m}^2$$

Area of the four walls with windows doors = $240 + 24 = 264 \text{ m}^2$

$$\text{or, } 4lh = 264$$

$$\text{or, } 4 \times 12 \times h = 264$$

$$\text{or, } h = \frac{264}{4 \times 12}$$

$$\text{or, } h = 5.5 \text{ m}$$

So, height of the square room is 5.5m.

Example 5

It costs Rs. 10,240 for laying carpet in a room which has a length twice its width and width twice its height at the rate of Rs. 80 per square meter. If the total area of windows and doors in the room is 5 m^2 , find how much it costs to paint on four walls and ceiling at the rate of 90 per square meter.

Solution,

Here let the height of the room (h) = $x \text{ m}$

Width of the room (b) = $2x \text{ m}$

And length of the room (l) = $2b$

$$= 2 \times 2x \text{ m} = 4x \text{ m}$$

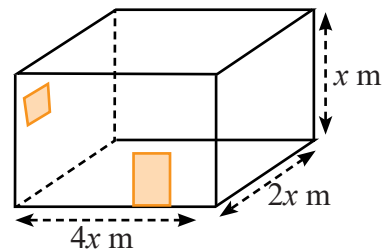

The per square meter cost for laying carpet in the room (R_1) = Rs. 80

The total cost for laying carpet in the room (T_1) = Rs. 10,240

The per square meter cost for painting (R_2) = Rs. 90

Total cost for painting the ceiling and four walls (T_2) = ?

Now, the area of the floor of the room (A_1) = $\frac{\text{Total cost for laying carpet } (T_1)}{\text{Per square meter cost for laying carpet } (R_1)}$

$$\text{or, } l \times b = \frac{10,240}{80} \quad [\because A = l \times b]$$

$$\text{or, } 4x \times 2x = 128$$

$$\text{or, } 8x^2 = 128$$

$$\text{or, } x^2 = \frac{128}{8}$$

$$\text{or, } x^2 = 16 \quad \text{or, } x = 4$$

\therefore Height of the room (h) = 4 m

Width of the room (b) = $2x$ m = 2×4 m = 8 m

Length of the room (l) = $4x$ m = 4×4 m = 16 m

Again, area of four walls and ceiling (A_2) = $2h(l + b) + lb$

$$= 2 \times 4(16 + 8) + 16 \times 8$$

$$= 8 \times 24 + 128$$

$$= 320 \text{ m}^2$$

Now, area of the ceiling and four walls except windows and doors (A_3) = $320 - 5 = 315 \text{ m}^2$

Total cost for painting the ceiling and four walls (T_2) = $A_3 \times R_2$

$$= \text{Rs. } 90 \times 315 = \text{Rs. } 28,350$$

\therefore The total cost for painting the ceiling and four walls is Rs. 28,350.

Exercise 5.3

1. Find the total cost for laying a carpet costing Rs. 130 per square ft. on the floor of the room having length 12 ft and breadth 11 ft.
2. Interior length, width, and height of a room are 15 ft, 12 ft, and 8 ft respectively. The room has two windows of 6ft \times 4 ft 6 inches and a door of 3 ft \times 6ft 6 inches. Except the window, door, and ceiling of the room, find out how much money is needed to paint the four walls at the rate of Rs 125 per square ft.
3. If the length of the square room is 15 ft and the height is 8 ft., find out how much it will cost to plaster the floor, four walls, and ceiling of the room at the rate of 120 per square ft.
4. The length, width, and height of an assembly hall are 32m, 32m, and 4m respectively. The building has 6 windows of 2.5m \times 1.8m and 2 doors of 4m \times 3m, then:
 - (a) Find the total area of the floor and ceiling of the building.

- (b) Find the total area of windows and doors.
- (c) Find the areas of four walls except for windows and doors.
- (d) If one chair occupies 2 square meter area of the floor, how many chairs of the same size can fit in that building?
- (e) Find the total cost of plastering all four walls at the rate of Rs 350 per square meter.
5. The floor area of the largest room in Simran's house was found 500 ft². There are three windows of size 6ft × 5ft and one door of size 3ft × 6.5ft. if the length of the room is 25 ft and height is 9 ft, find the total cost for coloring its four walls (except windows and door) at the rate of 300 per square foot.
6. The height of a squared room is 8 ft. The total cost for laying carpet on that room at the rate of 200 per square ft is 39,200. Find the cost for coloring on the four walls of the room at the rate of 350 per square ft.
7. A school pays Rs 7,056 for laying carpet at the rate of 144 per square meter on a square room for teachers and staff. Except for the windows and doors of the same room, when the paper is pasted on four walls at the rate of 400 per square meter a total of Rs 30,000 is needed. If the total area of windows and doors is 9 m², find the height of the room.
8. In Nima's house, the length of room is double of it's breadth and height of a room is 2.8 meters. Apart from the window, door, and ceiling of the room, Rs 54,000 is needed to draw the picture on its four walls at the rate of Rs 900 per square meter. If the area of windows and doors is 7.2 square meters, find out the total cost of laying tiles on the floor of the room at the rate of Rs 200 per square meter.
9. The length of a school meeting hall is twice the width and the width is twice the height. The school pays Rs 43,200 for coloring its four walls including windows and doors at the rate of 225 per square meter. Find the total cost for laying tiles on the floor of the room at the rate of 250 per square meter.
- 10. The size of a park decorated by a municipality is 50m × 40m. If the square slab of *dubo* sized 20 cm is land,**
- (a) Find, how many slabs are needed?
- (b) Find the total cost for laying slabs if the cost for laying per slab is Rs. 225.
- (c) After a few years, considering the park to be small, the municipality decided to increase the length and width by 15 m and 10 m respectively. Find out how many slabs need to be added to cover the square of the same length in the increased area and how much it costs at the same rate.

Project Work

- Sit in an appropriate group, Measure the length, width, and height of the classroom of the school you are studying in or the room you live in, as well as the length and height of windows and doors, and present the solution to the given questions in the class.**
 - Find the area of the floor and ceilings.
 - Find the areas of the four walls.
 - Find the areas of the four walls except for windows and doors.
 - Find out much it will cost to plaster four walls, ceiling, and floor according to the current rate.
 - Find out much it costs to paint four walls, and the ceiling according to the current rate in your village and town.
- You need to paint the walls of your school's ninth-grade classroom. The school asks you to prepare an estimate of the cost of painting the classroom. Find out the cost of painting the classroom and present it to the class.

Answers

- | | | |
|----------------------------|----------------------|-------------------------------|
| 1. Rs. 17160 | 2. Rs. 67500 | 3. Rs. 1,11,600 |
| 4. (a) $1,200 \text{ m}^2$ | (b) 51 m^2 | (c) 365 m^2 (d) 320 |
| (e) Rs. 1,27,750 | 5. Rs. 2,10,150 | 6. Rs. 1,12,000 |
| 7. 3 m | 8. Rs. 6,400 | 9. Rs. 32,000 |
| 10. (a) 50,000 | (b) Rs. 1,12,50,000 | (c) 3,750, Rs. 8,43,750 |

5.4 Area of triangular and quadrilateral shaped land

Activity 1

In order to prepare *kittanapi* in a systematic manner in Nepal, the Department of Surveying and Mapping was established in 2014 BS. Even now, under the department of surveying, *kittanapi*, *Geojedic napi*, and *Toponapi* has been developed in a detailed and systematic manner, and various surveys required in the country have been conducted. Study the following situations and discuss how to do a land survey in the area where you live is conducted.

1. Durga kumari's permanent home is in the hilly district. She has a 3 *Ropani* farm, 1 *Ropani* of *pakha bari*, and a house constructed on the land of 8 *aana* 3 *paisa* area. She at so has a triangular plot of an area 4 *aana* on the main roadside.
2. Ravilal's permanent home is in tarai. He is a landlord there. He has three *Biggha* of the farm, 1 *biggha* 3 *kattha* bari, and a house constructed on 1 *kattha* 2 *dhur* of land. Also, he has 4 *kattha* areas of the quadrangular plot on the main roadside.
3. Bhim Bahadur is an Amin. He calculates the area of the land according to the criteria issued by the Department of Survey. Here is the formula for finding the area of a triangle by converting the quadrilateral land into two triangles and find the area of both triangles and the area of the quadrilateral land from its sum.



There are land and ground surfaces in a variety of shapes. In this lesson, we study about finding the area of triangular and quadrilateral lands. When trading land, it is mandatory to measure its area. Square feet or square meters is the universal unit of land measurement. But the method and unit of measuring land area may vary from place to place. Units used for measuring land in use in different parts of Nepal are:

1. In hilly region, Ropani, Aana, Paisa, Daam are used to measure lands in hilly region.
2. In the terai region, Bigha, Kattha, Dhur etc are used to measure lands the terai region.

Activity 2

Based on the given table, it is possible to understand how much or how the area of land or plot is measured by converting it to universally accepted units (sq. feet or sq. meter). Discuss what units are being used to measure the area of land in the area where you live and present the findings in the classroom.

Units used in Terai region		sq. meter	sq. feet	Conversion into the units used in hilly region	Relationship between meter, feet and inch
1 <i>Bigha</i>	20 <i>Kattha</i>	6772.63	72900	13.31 <i>Ropani</i>	1 m = 3.2808 ft
1 <i>Kattha</i>	20 <i>Dhur</i>	338.63	3645	10.65 <i>Aana</i>	1 m = 39.37 inches
1 <i>Dhur</i>		16.93	182.25	2.13 <i>Paisa</i>	
Units used in hilly region				Conversion into the units used in terai region	
1 <i>Ropani</i>	16 <i>Aana</i>	508.72	5476	1.5023 <i>Kattha</i>	1 foot = 0.3048 m
1 <i>Aana</i>	4 <i>Paisa</i>	31.79	342.25	1.8777 <i>Dhur</i>	1 foot = 12 inches
1 <i>Paisa</i>	4 <i>Daam</i>	7.95	85.56		
1 <i>Daam</i>		1.99	21.39		

Conversion of units used in measuring the land

Example 1

Somnath had recently bought 8 *katthas* and 3 *dhurs* of land in Nawalparasi. If the area of land is only in square meter units, how many square meters area should be kept?

Solution

Area of land = 8 *Kattha* 3 *Dhur*

$$= 338.63 \times 8 \text{ m}^2 + 16.93 \times 3 \text{ m}^2$$

$$[\because \text{since } 1 \text{ Kattha} = 338.63 \text{ m}^2 \text{ and } 1 \text{ Dhur} = 16.93 \text{ m}^2]$$

$$= 2709.04 \text{ m}^2 + 50.79 \text{ m}^2$$

$$= 2759.83 \text{ m}^2$$

The 8 *Kattha* 3 *Dhur* land purchased by Somnath has an area of 2759.83 *square meters*.

Example 2

Convert the following area of land into 'Aana'.

- a) 2 Ropani 3 Aana b) 3 Kattha 9 Dhur

Solution,

$$(a) \text{ 2 Ropani 3 Aana} = 16 \times 2 \text{ Aana} + 3 \text{ Aana}$$

$$= 32 \text{ Aana} + 3 \text{ Aana}$$

$$= 35 \text{ Aana}$$

$$(b) \text{ 3 Kattha 9 Dhur} = 338.63 \times 3 \text{ sq. meter} + 16.93 \times 9 \text{ sq. meter}$$

$$[\because 1 \text{ Kattha} = 338.63 \text{ sq. meter} \text{ and } 1 \text{ Dhur} = 16.93 \text{ sq. meter}]$$

$$= 1015.89 \text{ sq. meter} + 152.37 \text{ sq. meter}$$

$$= 1168.26 \text{ sq. meter}$$

$$= \frac{1168.26}{31.79} \text{ Aana} [\because 1 \text{ Aana} = 31.79 \text{ m}^2]$$

$$= 36.75 \text{ Aana}$$

Example 3

The area of a land is 1560 ft^2 . Convert the area of the land as follows:

- (a) In Ropani, Aana, Paisa and Daam according to the units circulated in the himalian and mountain region.
- (b) In Bigha, Kattha and Dhur according to the units circulated in the terai region.

Solution,

(a) Area of the given land = 1560 ft^2

$$\begin{aligned} &= \frac{1560}{5476} \text{ Ropani} [\because 1 \text{ Ropani} = 5476 \text{ ft}^2] \\ &= 0.28489 \text{ Ropani} \\ &= 0.28489 \times 16 \text{ Aana} [\because 1 \text{ Ropani} = 16 \text{ Aana}] \\ &= 4.55824 \text{ Aana} \\ &= (4 + 0.55824) \text{ Aana} \\ &= 4 \text{ Aana and } 0.55824 \times 4 \text{ Paisa} [\because 1 \text{ Aana} = 4 \text{ Paisa}] \\ &= 4 \text{ Aana and } 2.23296 \text{ Paisa} \\ &= 4 \text{ Aana and } (2 + 0.23296) \text{ Paisa} \\ &= 4 \text{ Aana } 2 \text{ Paisa and } (0.23296 \times 4) \text{ Daam} [\because 1 \text{ Paisa} = 4 \text{ Daam}] \\ &= 4 \text{ Aana } 2 \text{ Paisa } 0.93 \text{ Daam} \end{aligned}$$

It is written as *Ropani – Aana – Paisa – Daam* 0 - 4 - 2 - 0.93 (*Ropani*).

Alternative Method

Area of land = 1560 sq. feet

$$\begin{aligned} &= \frac{1560}{5476} \text{ Ropani} [\because 1 \text{ Ropani} = 5476 \text{ sq. feet}] \\ &= 0.28489 \text{ Ropani} \end{aligned}$$

Now, convert 0.28489 Ropani into 'Aana' as,

$$\begin{aligned} 0.28489 \text{ Ropani} &= 0.28489 \times 16 \text{ Aana} [\because 1 \text{ Ropani} = 16 \text{ Aana}] \\ &= 4.55824 \text{ Aana} \\ &= (4 + 0.55824) \text{ Aana} \end{aligned}$$

Now, convert 0.55824 *Aana* into '*Paisa*' as,

$$= 0.55824 \times 4 \text{ Paisa} [\because 1 \text{ Aana} = 4 \text{ Paisa}]$$

$$= 2.23296 \text{ Paisa}$$

$$= (2 + 0.23296) \text{ Paisa}$$

Now, convert 0.23296 *Paisa* into '*Daam*' as,

$$= 0.23296 \times 4 \text{ Daam} [\because 1 \text{ Paisa} = 4 \text{ Daam}]$$

$$= 0.93 \text{ Daam}$$

So, area of given land = 1560 sq. feet = 0 *Ropani*, 4 *Aana*, 2 *Paisa* 0.93 *Daam*.

It is written as 0 - 4 - 2 - 0.93 (*Ropani*).

(b) Area of given land = 1560 *sq. feet*

$$= \frac{1560}{72900} \text{ Bigha} [\because 1 \text{ Bigha} = 72900 \text{ sq. feet}]$$

$$= 0.021399 \text{ Bigha}$$

Now, convert 0.021399 *Bigha* into *Kattha* as,

$$0.021399 \text{ Bigha} = 0.021399 \times 20 \text{ Kattha} [\because 1 \text{ Bigha} = 20 \text{ Kattha}]$$

$$= 0.42798 \text{ Kattha}$$

$$= (0 + 0.42798) \text{ Kattha}$$

Now, convert 0.42798 *Kattha* into *Dhur* as,

$$= 0.42798 \times 20 \text{ Dhur} [\because 1 \text{ Kattha} = 20 \text{ Dhur}]$$

$$= 8.5596 \text{ Dhur}$$

$$= 8.56 \text{ Dhur}$$

So, the area of land = 1560 sq. feet = 0 *Bigha*, 0 *Kattha*, 8.56 *Dhur* = 8.56 *Dhur*.

It is written in the form of *Bigha – Kattha – Dhur – 0* as 0-0-8.56-0 *Bigha*.

Example 4

Plot No.	विवरण (घर, आवादी, इत्यादि)	जग्गाधनीको हकहिस्सा	मोहीको नाम थर	किसिम वा वर्ग	Area / sq. meter	Remarks	प्रमाणित गर्नेको दस्तखत
244	आवादी	एकलौटी		धनहर/ खेत	0-1-15-0 (<i>Bigha</i>) (0-20-20-4)		
0	रैकर निजी			दोयम	592.52		
247	आवादी	एकलौटी		धनहर/खेत	0-1-15-0 (<i>Bigha</i>) (0-20-20-4)		
0	रैकर निजी			दोयम	592.52		
				Total Area	1185.04 sq. meter		

In the above *Lalpurja* the area of the land on plot no. 244 is 1 *Kattha* and 15 *Dhur* or 592.52 m². Test the area using the area conversion table on the front page.

Solution,

The area of the land on plot no. 244 in given *Lalpurja* = 1 *Kattha* 15 *Dhur*

$$= 20 \text{ Dhur} + 15 \text{ Dhur} [\because 1 \text{ Kattha} = 20 \text{ Dhur}]$$

$$= 35 \text{ Dhur}$$

$$= 16.93 \times 35 \text{ m}^2 [\because 1 \text{ Dhur} = 16.93 \text{ m}^2]$$

$$= 592.55 \text{ m}^2$$

Example 5

गा.वि.स./ न.पा	बडा न. नक्सा सिट	कित्ता न.	विवरण (घर, आवादी, इत्यादि)	ज.ध.को हक हिस्सा	मोहिको नाम थर	किसिम वा वर्ग	क्षेत्रफल बिगाहा/वर्गमिटर	मोठ / पाना न.
??	3	2731	आवादी	सबै		खेत	0-0-10-0	28
	3 (a)		रैकर निजी			अवल	169.32	10833
						Total area 169.32 sq. Meter		

In the above Lalpurja the area of the land on plot no. 2731 is 0-0-10-0 (*Biggha*) or 169.32 m². Test the area using the area conversion table on the front page.

Solution,

The area of the land on plot no. 2731 in given *Lalpurja* = 0 *Biggha* 0 *Kattha* 10 *Dhur* 0 *Kunua*

$$= 10 \text{ Dhur}$$

$$= 10 \times 16.93 \text{ m}^2 \quad [\because 1 \text{ Dhur} = 16.93 \text{ m}^2]$$

$$= 169.30 \text{ m}^2$$

You can also convert from one unit to another using the area conversion option by installing NaaPI apps on mobile. Using the plotter option we can draw the picture and find the area on the basis of the length of each edge using the primary and secondary unit tool.

Area of triangular and quadrangular land

Example 6

A blueprint map of one of the places of Kathmandu is given in the picture below. Here you can see places of the land of different sizes. This map print is drawn on a scale of 1: 500. Some of these are given in the picture below:



नेपाल सरकार
भूमिसुधार तथा व्यवस्था मन्त्रालय
नापी विभाग

नापी कार्यालय, डिल्लीबजार

जिल्ला: काठमाण्डौ

गा.बि.स., न.पा., महानगर

बडा न. १६

सीट न. १०२ १०२३ ०६

नक्सा प्रिन्ट (ब्लु प्रिन्टको सट्टामा उपलब्ध गराइएको)

स्केल: १:५००



The shape of plot no. 559 in this blue print is triangular. The actual measurement of each sides is given in the figure.

- Find the area of the given plot.
- Find the area as *Ropani - Aana - Paisa - Daam*.

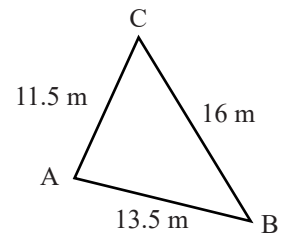

Solution,

- (a) In given triangular plot,
length of edge AB (c) = 13.5 m
length of edge BC (a) = 16 m
length of edge CA (b) = 11.5 m
Perimeter (p) = $a + b + c = 13.5 + 16 + 11.5 = 41$ m
Semi-perimeter (s) = $\frac{p}{2} = \frac{41}{2} = 20.5$ m
Area (A) = ?

We know that,

$$\begin{aligned} A &= \sqrt{s(s-a)(s-b)(s-c)} \\ &= \sqrt{20.5(20.5-16)(20.5-11.5)(20.5-13.5)} \\ &= \sqrt{20.5 \times 4.5 \times 9 \times 7} \\ &= \sqrt{5811.75} \\ &= 76.23 \text{ m}^2 \end{aligned}$$

\therefore Area of the plot is 76.23 sq. meter.

- (b) The area of the plot is less than 'Ropani'. So convert into 'Aana' as
 $76.23 \text{ m}^2 = \frac{76.23}{31.79} \text{ Aana}$ [$\because 1 \text{ Aana} = 31.79 \text{ m}^2$]
 $= 2.3979 \text{ Aana}$
 $= (2 + 0.3979) \text{ Aana}$
 $= 2 \text{ Aana and } 0.3979 \times 4 \text{ Paisa}$ [$\because 1 \text{ Aana} = 4 \text{ Paisa}$]
 $= 2 \text{ Aana and } 1.5916 \text{ Paisa}$
 $= 2 \text{ Aana } 1 \text{ Paisa and } 0.5916 \times 4 \text{ Daam}$ [$\because 1 \text{ Paisa} = 4 \text{ Daam}$]
 $= 2 \text{ Aana } 1 \text{ Paisa } 2.37 \text{ Daam}$
 $= 0 - 2 - 1 - 2.37 \text{ (Ropani)}$

Example 7

The actual measurement of plot no. 278 in above example 4 is presented below:

- (a) Find the area of the plot.
(b) Find the area as *Bigha – Kattha – Dhur* – 0.

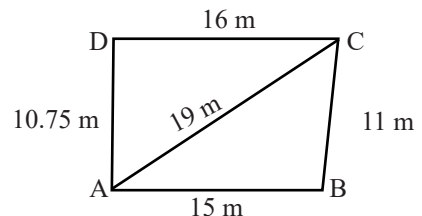

Solution,

- (a) The plot is rectangular shape; which is made in the ratio of 1:500. Diagonal AC divided the rectangle into two triangle.

To find area of ΔABC ,

length of side BC (a) = 11 m

length of side AC (b) = 19 m

length of side AB (c) = 15 m

$$\text{Semi-perimeter of } \Delta ABC (s) = \frac{a + b + c}{2} = \frac{11 + 19 + 15}{2} = 22.5 \text{ m}$$

$$\begin{aligned} \text{Area of } \Delta ABC &= \sqrt{s(s-a)(s-b)(s-c)} \\ &= \sqrt{22.5(22.5-11)(22.5-19)(22.5-15)} \\ &= \sqrt{22.5 \times 11.5 \times 3.5 \times 7.5} \\ &= \sqrt{6792.1875} \\ &= 82.41 \text{ m}^2 \end{aligned}$$

To find area of ΔDAC ,

length of side DC (d) = 16 m

length of side AC (b) = 19 m

length of side DA (e) = 10.75 m

$$\text{Semi-perimeter of } \Delta DAC (s') = \frac{d + b + e}{2} = \frac{16 + 19 + 10.75}{2} = 22.88 \text{ m}$$

$$\begin{aligned} \text{Area of } \Delta DAC (A) &= \sqrt{s'(s'-a)(s'-b)(s'-c)} \\ &= \sqrt{22.88(22.88-16)(22.88-19)(22.88-10.75)} \\ &= \sqrt{22.88 \times 6.88 \times 3.88 \times 12.13} \\ &= \sqrt{7408.6142} \\ &= 86.07 \text{ m}^2 \end{aligned}$$

Now, area of rectange ABCD = Area of ΔABC + Area of ΔDAC

$$= 82.41 \text{ m}^2 + 86.07 \text{ m}^2$$

$$= 168.48 \text{ m}^2$$

\therefore Area of the given plot is 168.48 m².

(b) Area of plot = 168.48 m^2

Here, area of the given plot 1 *Kattha* is less than 338.63 sq. meter. So, we convert into *Dhur*,

Area of plot = 168.48 m^2

$$= \frac{168.48}{16.93} \text{ Dhur} \quad [\because 1 \text{ Dhur} = 16.93 \text{ sq. meter}]$$

$$= 9.95 \text{ Dhur}$$

So, area of the plot is 0-0-9.95-0 '*Biggha*'.

Exercise 5.4

1. Answer the following questions based on the area conversion table presented on the front page:

- (a) According to the methods of mapping lands in Nepal, what are the ways used in mountainous and hilly areas?
- (b) What is the method of measuring land in the area where you live?
- (c) How many square feet of area is in one *Ropani*?
- (d) How many *aanas* are in one *Ropani* and how many square feet are in one *aana*?
- (e) How many square meters of the area is in one *Bigha*?
- (f) How many *Katthas* are there in one *Biggha* and how many square feet areas are in one *Kattha*?
- (g) Which unit of an *aana* and a *kattha* has more square meter areas?
- (h) If the area of rectangular land with a width of 37 feet is one *ropani*, what is the length of that land?
- (i) A landlord of Terai has 10 *Bigghas* of land. According to the *Ropani* unit, how many *ropanis* of land does he have?

2. Convert the following unit areas of land into square feet units:

- (a) 2 *Kattha* (b) 4 *aana* (c) 8 *Dhur*
- (d) 5 *aana* (e) 6 *aana* 3 *Paisa* (f) 4 *Kattha* 10 *Dhur*

3. Convert the following unit areas of land into square meter units

- (a) 2 *ropani* (b) 1 *Bigha* (c) 16 *Dhur* (d) 3 *Kattha* (e) 5 *Kattha* 10 *Dhur*

4. Convert the following unit areas of land into Aana units:

- (a) 16 Dhur (b) 4 Kattha (c) 3 Kattha 2 Dhur
 (d) 6 Kattha 10 Dhur (e) 2 Ropani (f) 1 Bigha

5. Convert the following unit areas of land into Dhur units:

- (a) 3 aana (b) 6 aana 3 paisa (c) 16 Kattha 5 Dhur
 (d) 1 Bigha 4 Kattha (e) 2 Biggha

6. A plot of land with one Ropani area of Aitaman is faced on 20 feet road. The length of the face on the side of the road is 148 feet. When the land has to be divided into four equal areas, what are the areas of each plot? What is the length and width of each plot?

7. Convert the areas of the following lands as follows:

- (a) Ropani-Aana- Paisa-Daam (R-A-P-D)
 (b) Biggha- Kattha- Dhur (B-K-D)
 (i) 3056 ft² (ii) 1426.85 ft² (iii) 5026.80 ft²
 (iv) 2167.24 ft² (v) 80736.75 ft²

8. The area of land given in the following table is 0-5-3-0 Biggha or 1743.70 ft². Test using the area conversion table on the front page:

दाई न. / नक्सा सीट न.	फिता न. / खण्डे न.	विवरण (घर, आवादी, इत्यादि)	जग्गाधनीको हकसिस्सा	मोहीको नाम दर	किसिम वा वर्ग	क्षेत्रफल / व.मि.	कैफियत
5	166	आवादी	एकलौटी		धनहर / खेत	0-5-30-30-4	
		रैकर निजी			जम्मा	1743.70	
						जम्मा क्षेत्रफल 1743.70 वर्गफिट	

9. The area of the land in the given Lalpurja is 677.26 ft². In this map, the area of the map is given in square meters only. Find the area using the area conversion table on the front page:

- (a) According to the hilly system Ropani- Aana- Paisa -Daam format
 (b) According to the terai system Biggha- Kattha- Dhur format
 (c) In square feet.

वार्डन./ नक्सा सीट न.	फिक्ता न. /खण्डे न.	विवरण (घर, आवादी, इत्यादि)	जग्गाधनीको हकसिस्सा	जग्गाधनीको हकहिससा	मोहीको नाम थर	किसिम वा वर्ग	क्षेत्रफल/ व.मि.	कैफियत
४	३३४	आवादी,	एकलौटी			घनहर /खेत /	०-०-०-०	
४घ	३३४	रैकर निजी				दोयम	६७७.२६	
	०					जम्मा क्षेत्रफल ६७७.२६ वर्गमिटर		

10. The figure on the right shows a map of the fragmented land as a plot. The area of each plot is given according to the *Ropani-Aana-Paisa- Daam*.

- Convert the area of plots no 1, 2, 6, 8, and 9 into square meter units.
- Convert the area of plots no 4, 18, 20, and 22 into square meter units.
- Convert the area of plots no 9, and 22 into *Biggha- Kattha- Dhur* units.



11. Find the area of the land given in the following measurements:

- According to *Ropani- Aana- Paisa -Daam* units.
- According to *Biggha- Kattha- Dhur* units

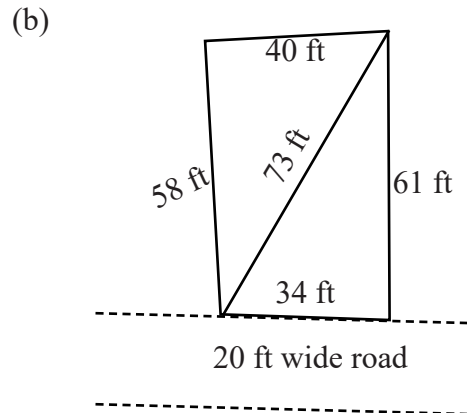
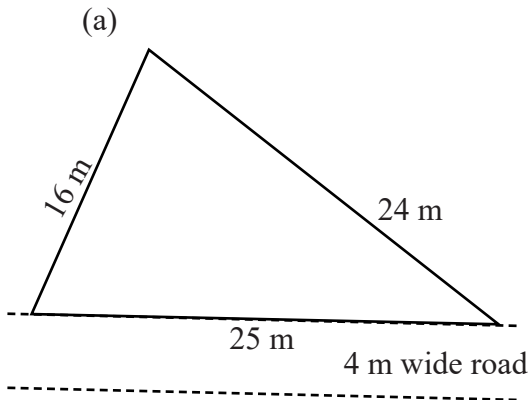

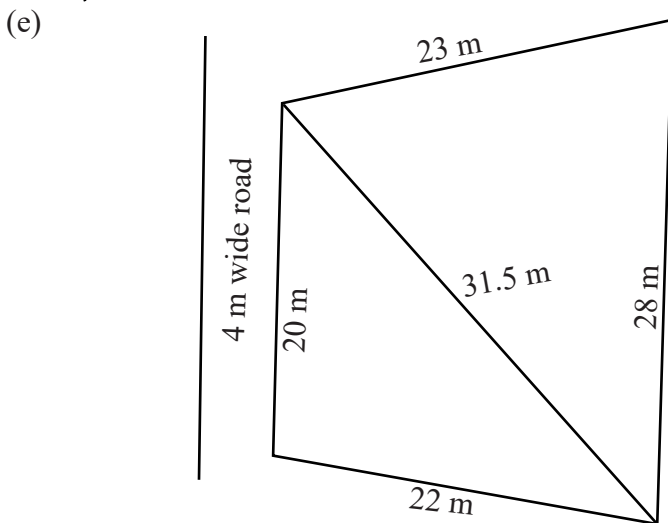
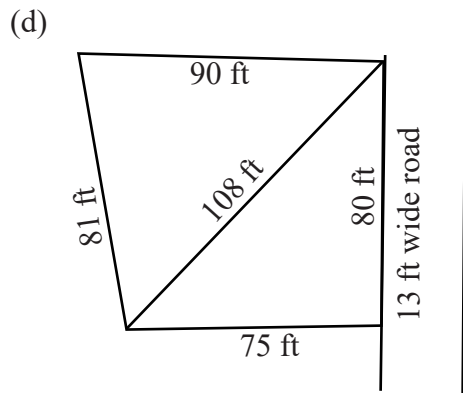
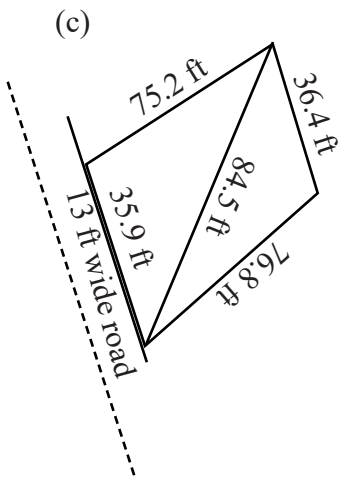

12. The perimeter of a triangular land is 160 feet. If the ratio of each edge of the land is 5:7:8, find its area into Dhur.

Project Work

1. Divide the students in the class into appropriate groups (with at least 5 people in each group). Divide the responsibilities for each person in the group (two people for measuring with a measuring tape, 1 person for observing measurement, 1 person for taking notes, one person for overseeing all the work). With the necessary materials (measuring tape, ruler, pencil, etc), two groups measure the area of certain parts of the school play ground(triangular and quadrangular part) in their own way. Similarly, other two groups find out the area of the open space of any public places (temple premises, park, play ground, open space, and open space of the school etc.) near the school. Draw an area with with a map of the work done in this way and present it in the classroom. Compare the similarities between the area of the same site discovered by each of the two groups and choose the right option with the help of the teacher.
2. How much land does each student have in the name of his/her family? How much and how has the area been kept in the Lalpurja for its verification? Can you find out the area of land in the name of your family?

When, from whom and how was the land surveyed? Gather information and present it in the classroom with the help of your parents, community elders and related people.

Answers

1. Show to your teacher.
2. (a) 72.90 ft^2 (b) 1369 ft^2 (c) 1458 ft^2
(d) 1711.25 ft^2 (e) 2310.18 ft^2 (f) 16402 ft^2
3. (a) 1017.44 ft^2 (b) 6772.63 ft^2 (c) 270.88 ft^2
(d) 1015.89 ft^2 (e) 1862.45 ft^2
4. (a) 8.53 Aana (b) 42.60 Aana (c) 33.03 Aana
(d) 69.24 Aana (e) 32 Aana (f) 213.05 Aana
5. (a) 5.63 Dhur (b) 12.67 Dhur (c) 325 Dhur
(d) 480 Dhur (e) 800 Dhur

6. 1369 ft², length 37 ft, width 37 ft
7. (i)–(a) 0-8-3-2.87 (*Ropani*) (b) 0-0-16.77 (*Biggha*)
 (ii)–(a) 2-12-3-2.02 (*Ropani*) (b) 0-4-4.2 (*Biggha*)
 (iii)–(a) 0-14-2-3 (*Ropani*) (b) 0-1-7.58 (*Biggha*)
 (iv)–(a) 4-4-0-2.6 (*Ropani*) (b) 0-6-7.99 (*Biggha*)
 (v)–(a) 14-11-3-2.39 (*Ropani*) (b) 1-2-3 (*Biggha*)
8. (a) 1-5-1-0.2 (*Ropani*) (b) 0-1-20 (*Biggha*) (c) 7289.92 ft²
9. (a) plot no. (1) 0-3-2-3 / 117.42 m²
 plot no. (2) 0-4-0-2 / 143.06 m²
 plot no. (6) 0-4-0-0 / 127.16 m²
 plot no. (8) 0-3-1-0 / 103.32 m²
 plot no. (9) 0-5-1-3 / 172.87 m²
 (b) plot no. (4) 0-4-2-0 / 1540.12 ft²
 plot no. (18) 0-3-2-2 / 1240.65 ft²
 plot no. (20) 0-4-0-0 / 1433.17 ft²
 plot no. (22) 0-7-0-0 / 2395.75 ft²
 (c) plot no. (9) 0-0-10.2 (*Biggha*)
 plot no. (22) 0-0-13.14 (*Biggha*)
10. (a) 184.89 ft² (i) 0-5-3-1.04 (*Ropani*) (ii) 0-0-10.91 (*Biggha*)
 (b) 2187.22 ft² (i) 0-6-1-2.25 (*Ropani*) (ii) 0-0-11.77 (*Biggha*)
 (c) 2746.54 ft² (i) 0-8-0-0.3 (*Ropani*) (ii) 0-0-15.07 (*Biggha*)
 (d) 6565.80 ft² (i) 1-3-0-2.9 (*Ropani*) (ii) 0-1-16.02 (*Biggha*)
 (c) 526.15 ft² (i) 1-0-2-0.7 (*Ropani*) (ii) 0-1-11.07 (*Biggha*)
11. (a) 350.54, 1.92 *Dhur*

6.0 Review

Draw the following pictures and discuss the following questions in your group. Present your answers in your class:

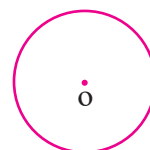
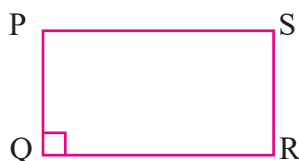
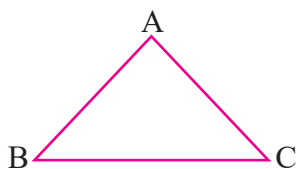

- How many sides (edges) are there in the given figures?
- How can we calculate the perimeters of plain surfaces in each figure?
- How can we calculate the area of plain surfaces in each figure?
- If we pile up the same shape and size of cardboard papers, what type of shape will be formed?
- Do you see the pile-up of papers?

6.1 Introduction to prism

Activity 1

Divide the students in class into a group of 5 students in each. Take one solid object as given below in each group, observe it and discuss the following questions:



(i)

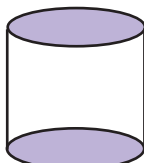

(ii)

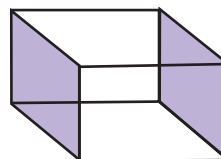

(iii)



(iv)



(v)

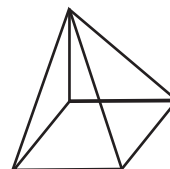

(vi)

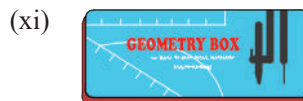
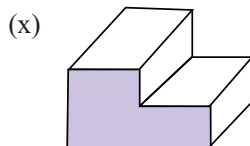

- Which of the above objects have their opposite surfaces congruent and parallel?
- How many straight edges consist in each object?
- What are the shapes of polygons with congruent and parallel opposite sides in given objects
- How many vertices are there in each object?

A prism is a three-dimensional solid object with parallel and congruent two opposite polygons.

6.2 Cross-section area of prism

Activity 2

Divide the students in class into a group of 5 students in each. Take one solid object of triangular or rectangular or square shapes.

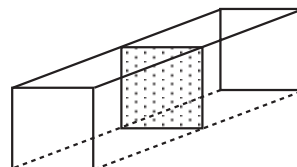
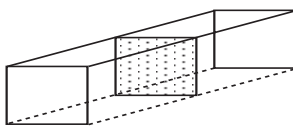
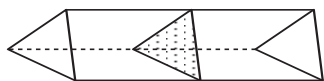

Cut the prism from its middle part as shown in the figure. Observe the surface of the object, discuss in your group and present it in your class. Eg. the group work of the third group was as follows:

The area of the triangle MNO is the cross-sectional area of the prism if we cut the solid object of the triangular base making the triangular face parallel and perpendicular to its length or height.

Therefore, $(\triangle ABC \cong \triangle MNO \cong \triangle A'B'C')$

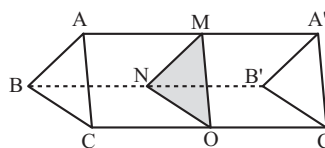

Characteristics of Prism

- It has two parallel congruent opposite polygons, called the base of the prism. The prism of the base triangle is a triangular prism and the prism of the base rectangle is a rectangular prism.
- The surface parallel with the base in a prism is called the cross-section of the prism. This cross-section is congruent with the base.
- Generally there are two types of prism called oblique and right. In this class, we discussed on right prism only (all the faces except the base are perpendicular to the base).
- The areas of all faces other than their bases in the prism is called the lateral surface area of the prism.
- The perpendicular distance between two bases is the height or length of the prism.
- The volume of the prism $(V) = \text{Area of the base } (A) \times \text{height } (h)$

Activity 3

Is our textbook a prism? What type of prism is this? Compare the area of the base of the first page, middle page, and last page of the book. What does each page in the book of the prism represents?

Area of the bases in a triangular prism

- Area of the equilateral triangle $(A) = \frac{\sqrt{3}}{4} a^2$
- Area of the isosceles triangle $(A) = \frac{b}{4} \sqrt{4a^2 - b^2}$
- Area of the scalen triangle $(A) = \sqrt{s(s-a)(s-b)(s-c)}$
where, $s = \frac{a+b+c}{2}$
- Area of right angled triangle $(A) = \frac{1}{2} \times p \times b$
- Area of right angle isosceles triangle $(A) = \frac{1}{2} p^2$
or, $\frac{1}{2} b^2$
- Area of the base in a rectangular prism $(A) = l \times b$
- Area of the base in square prism $(A) = l^2$

6.3 Lateral surface area of prism

Activity 4

Distribute solid objects of triangular, rectangular and square base in different groups and trace the object in your copy.

The group work of group 3 is as below:

They took prism of six faces and denoted its length, breadth and height by l , b and h respectively. The faces of the prism except the bases are

ABHE, DCGF, ADFE and BCGH

All the faces are rectangular and each surface has:

$$\text{Area of the face ABHE } (A_1) = l \times h = lh$$

$$\text{Area of the face DCGF } (A_2) = l \times h = lh$$

$$\text{Area of the face ADFE } (A_3) = b \times h = bh$$

$$\text{Area of the face BCGH } (A_4) = b \times h = bh$$

Sum of the areas of all faces:

$$= A_1 + A_2 + A_3 + A_4$$

$$= lh + lh + bh + bh$$

$$= 2lh + 2bh$$

$$= 2h(l + b) = 2(l + b) \times h = P \times h$$

[Where, P = perimeter of the base]

So, the sum of areas of all faces except its two bases is the lateral surface area of the prism.

$$\text{Lateral surface area of the prism (LSA)} = 2h(l + b)$$

$$\text{Also, Lateral surface area of prism (LSA)} = P \times h$$

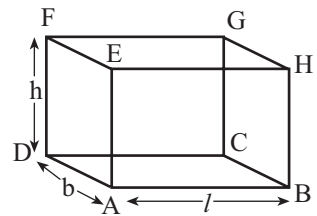

Example 1

Find the cross sectional area and lateral surface area of following prism.

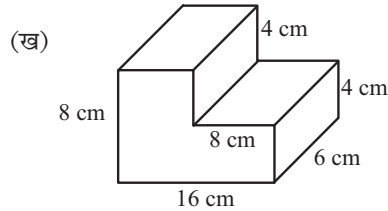
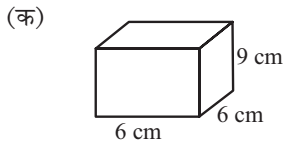

Solution,

Here,

- a) In given prism,
length (l) = 6 cm, breadth (b) = 6 cm and height (h) = 9 cm

We know that,

$$\begin{aligned} \text{Cross sectional area of prism} &= \text{base area of prism} \\ &= l \times b = 6 \times 6 = 36 \text{ cm}^2 \end{aligned}$$

$$\text{So, cross sectional area of prism} = 36 \text{ cm}^2$$

$$\text{Again, perimeter of the base (P)} = (6 + 6 + 6 + 6) \text{ cm} = 24 \text{ cm}$$

$$\text{Lateral surface area of prism} = P \times h = 24 \text{ cm} \times 9 \text{ cm} = 216 \text{ cm}^2$$

- b) Extend line CD upto G in the figure. Area of rectangle ABCG (A_1)
= AB \times BC
= 16 \times 4
= 64 cm^2

$$\begin{aligned} \text{Area of the rectangle DEFG (A}_2\text{)} \\ &= DE \times EF = 4 \times 8 \\ &= 32 \text{ cm}^2 \end{aligned}$$

$$\begin{aligned} \text{Now, Cross sectional area of prism is} \\ &= A_1 + A_2 \\ &= 64 + 32 \\ &= 96 \text{ cm}^2 \end{aligned}$$

Again, Perimeter of the base (P)

$$\begin{aligned} &= AB + BC + CD + DE + EF + FA \\ &= 16 + 4 + 8 + 4 + 8 + 8 \\ &= 48 \text{ cm} \end{aligned}$$

$$\text{length of prism (l)} = 6 \text{ cm}$$

$$\begin{aligned} \text{Lateral surface area of prism} &= P \times l \\ &= 48 \times 6 \\ &= 288 \text{ cm}^2 \end{aligned}$$

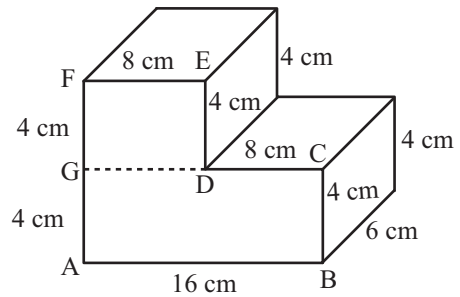

6.4 Total surface area of prism

Activity 5

Distribute some cubical hollow boxes of chalk or ink and rectangular hollow boxes of a shop or matchbox to the student's group. Open its faces slowly and trace them on chart paper. Present the answer to the following questions in your class.



- What type of shape is formed?
- How many faces are congruent and how many are not congruent in those shapes?
- If we fold the cubical and rectangular objects, can we find the original shape?
- Find the area of all faces of these cubical and rectangular objects and sum the areas. Then find the formula to find the total surface areas of cubical and rectangular objects.

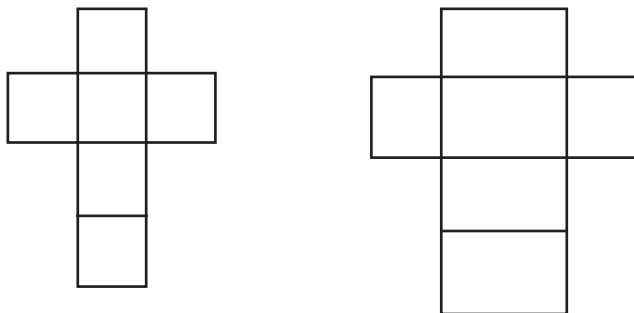

The chalk box is cubical and it has six faces. So, all faces are square in shape. The area of all faces is equal. If the side of one edge is l the area will be l^2 . The area of all square surfaces = $6l^2$ sq. unit

The area of each faces in a cubical prism = l^2

The total surface area of the cubical prism (A) = $6l^2$

Likewise, there are six faces in match boxes. The box is cuboid in shape. Three faces out of six are congruent. The total surface area will be found by adding the areas of all faces.

The sum of areas of all six bases is the total surface area of rectangular based prism.

Total surface area of rectangular base prism (TSA) = $2(lb + bh + hl)$

or, TSA = $2A + p \times h$

where, A = Area of base

P = Perimeter of base

Example 2

Find total surface area of given prism:

Solution,

Here, length of cubical prism (l) = 3 cm

Total surface area = $6l^2 = 6 \times (3 \text{ cm})^2 = 54 \text{ cm}^2$

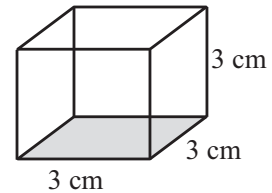

Example 3

A school constructed a rectangular water tank as the figure below, for drinking water. The length of the tank is 12 ft., breadth of the tank is 10 ft and height of the tank is 6 ft. Find the total surface area of the water tank:

Solution,

Here,

length of the water tank (l) = 12 ft

breadth (b) = 10 ft

height (h) = 6 ft

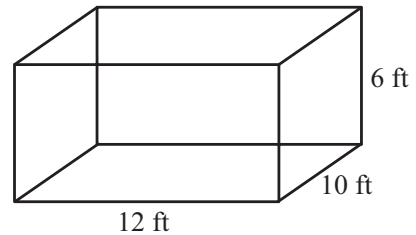

By formula,

$$\begin{aligned} \text{Total surface area of the tank (A)} &= 2(lb + bh + hl) \\ &= 2(12 \times 10 + 10 \times 6 + 6 \times 12) \text{ ft}^2 \\ &= 2(120 + 60 + 72) \text{ ft}^2 \\ &= 2 \times 252 \text{ ft}^2 \\ &= 504 \text{ ft}^2 \end{aligned}$$

\therefore Total surface area of the tank is 504 ft².

Alternative Method

$$\begin{aligned}\text{Here, area of the base (A)} &= l \times b \\ &= 12 \times 10 \\ &= 120 \text{ ft}^2\end{aligned}$$

$$\begin{aligned}\text{Perimeter of the base (P)} &= 2(l + b) \\ &= 2(12 + 10) \\ &= 44 \text{ ft}\end{aligned}$$

$$\begin{aligned}\text{Total surface area of the tabnk (TSA)} &= 2A + P \times h \\ &= 2 \times 120 + 44 \times 6 \\ &= 240 + 264 \\ &= 504 \text{ ft}^2\end{aligned}$$

Example 4

Find total surface area of the triangular base prism:

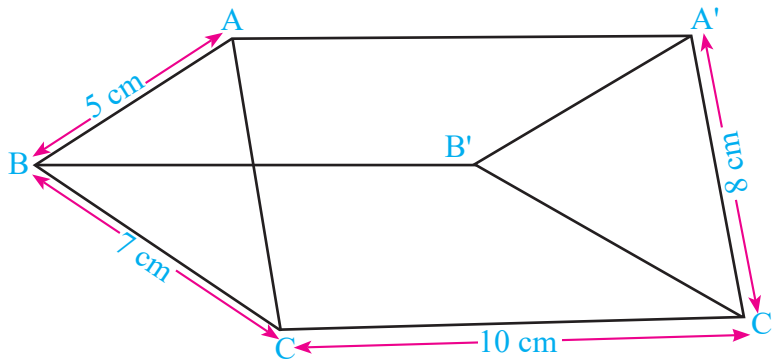

Solution,

In base of prism $\triangle ABC$,

$$AB (c) = 5 \text{ cm}$$

$$BC (a) = 7 \text{ cm}$$

$$CA (b) = 8 \text{ cm}$$

$$\text{Now, half perimeter (s)} = \frac{a + b + c}{2} = \frac{7 + 8 + 5}{2} = 10 \text{ cm}$$

$$\begin{aligned}\text{Area of the triangular base } \triangle ABC (A) &= \sqrt{s(s-a)(s-b)(s-c)} \\ &= \sqrt{10(10-7)(10-8)(10-5)} \\ &= \sqrt{10 \times 3 \times 2 \times 5}\end{aligned}$$

$$= \sqrt{300}$$

$$= 17.32 \text{ cm}^2$$

$$\begin{aligned} \text{Perimeter of the base } (P) &= a + b + c \\ &= 7 + 8 + 5 \\ &= 20 \text{ cm} \end{aligned}$$

$$\text{length of the prism } (l) = 10 \text{ cm}$$

$$\begin{aligned} \text{Now, Total surface area (TSA)} &= 2A + P \times l \\ &= 2 \times 17.72 + 20 \times 10 \\ &= 34.64 + 200 \\ &= 234.64 \text{ cm}^2 \end{aligned}$$

6.5 Volume of prism

Activity 5

How can we find the volume of rectangular base solid objects? On the basis of formula to find volume of rectangular base prism, ask students to find the volume of other prism:

Volume of prism (V) = Area of base \times height = $A \times h$
 Relationship between liter, cubic centimeter and cubic meter,
 $1000 \text{ cm}^3 = 1 \text{ l}$ and $1 \text{ m}^3 = 1000 \text{ l}$

Example 5

Find the volume and total surface area of following prism:

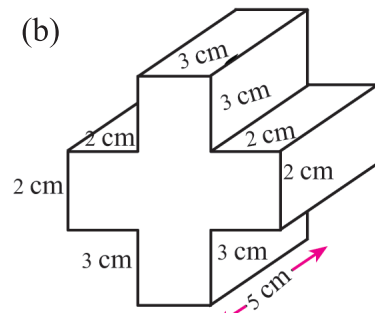
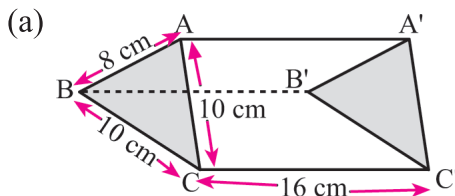

Solution

Here,

(a) The given prism is isosceles triangle base prism.

where, $BC = AC = (a) = 10 \text{ cm}$

base $(AB) = (b) = 8 \text{ cm}$

$$\begin{aligned} \text{Area of the triangular base (A)} &= \frac{8}{4} \sqrt{4a^2 - b^2} \\ &= \frac{8}{4} \sqrt{4 \times (10)^2 - (8)^2} \\ &= \frac{8}{4} \sqrt{400 - 64} \\ &= 8\sqrt{21} = 836.66 \text{ cm}^2 \end{aligned}$$

Perimeter of the base $(P) = a + a + b = (10 + 10 + 8) = 28 \text{ cm}$

Height or length of the prism $(h) = 16 \text{ cm}$

Lateral surface area of the prism $(LSA) = P \times h = 28 \times 16$
 $= 448 \text{ cm}^2$

Total surface area of the prism $(TSA) = 2 \times A + LSA$
 $= 2 \times 36.66$
 $= 73.32 + 448$
 $= 521.32 \text{ cm}^2$

Volume of the prism $(V) = A \times h = 8\sqrt{21} \times 16 \text{ cm}^3$
 $= 128\sqrt{21} \text{ cm}^3$

(b) Join I, L, and C, F as figure.

Now, area of square IJKL $(A_1) = (2 \text{ cm})^2$
 $= 4 \text{ cm}^2$

Area of the rectangle ABGH (A_2)
 $= (3 + 2 + 3) \text{ cm} \times 3 \text{ cm}$
 $= 8 \times 3 \text{ cm}^2 = 24 \text{ cm}^2$

Area of the square CDEF $(A_3) = (2 \text{ cm})^2$
 $= 4 \text{ cm}^2$

Cross sectional area of the prism $(A) = A_1 + A_2 + A_3$
 $= (4 + 24 + 4) \text{ cm}^2$
 $= 32 \text{ cm}^2$

Perimeter of the base (P)

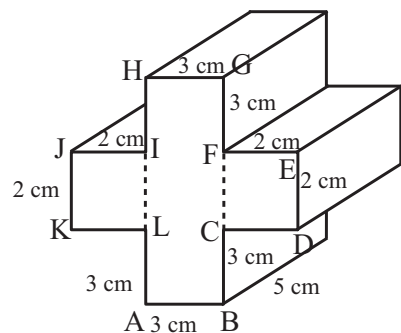

$$\begin{aligned}
&= AB + BC + CD + DE + EF + FG + GH + HI + IJ + JK + KL + LA \\
&= (3 + 3 + 2 + 2 + 2 + 3 + 3 + 3 + 2 + 2 + 2 + 3) \text{ cm} \\
&= 30 \text{ cm}
\end{aligned}$$

Height (h) = 5 cm

Lateral surface area (LSA) = $P \times h = 30 \times 5 \text{ cm}^2 = 150 \text{ cm}^2$

Total surface area (TSA) = $2 \times A + \text{LSA}$
 $= 2 \times 32 + 150$
 $= 64 + 150$
 $= 214 \text{ cm}^2$

Volume of prism (V) = $A \times h$
 $= 32 \times 5 = 160 \text{ cm}^3$

Exercise 6.1

1. What is the volume of prism whose cross-sectional area is 35 cm^2 and height is 10 cm?
2. Find the lateral surface area of the prism of the perimeter of 36 cm and height of 8 cm.
3. Find the total surface area of a prism cross-sectional area and lateral surface area are 40 cm^2 and 175 cm^2 respectively

4. Find the cross-sectional area, lateral surface area, total surface area, and volume of the following prisms.

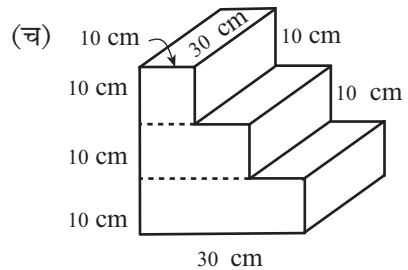
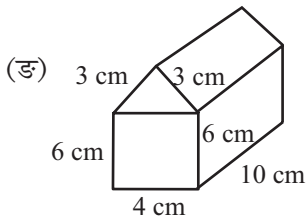
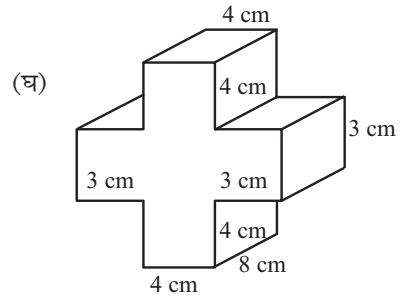
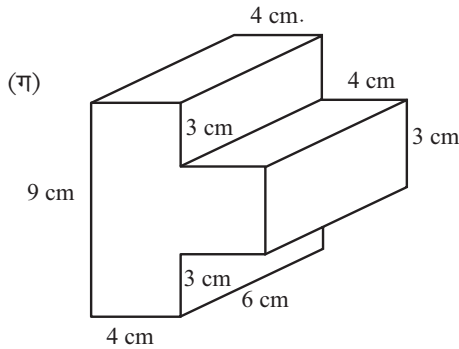
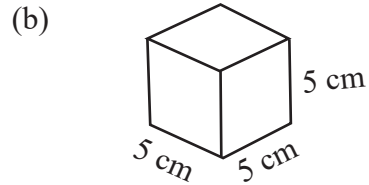
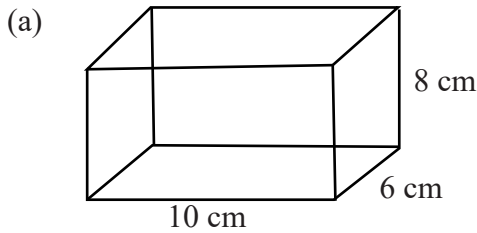

5. If there is a cuboidal prism having 6 cm length, 5 cm breadth, and 8 cm height:

- Find the area of cross section?
 - Find the lateral surface area?
 - Find the volume?
- A rectangular tank is 2 m long 1.5 m broad and 1 m high. Find the capacity of the tank in liters.
 - Divide a timber cube of 20 cm long into 8 equal parts. Find the length of each piece.

8. Find the cross-sectional area, lateral surface area, total surface area, and volume of the following prism.

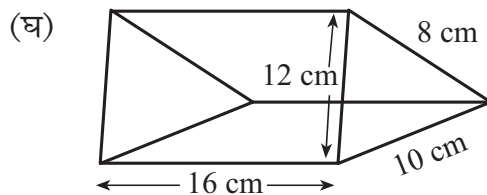
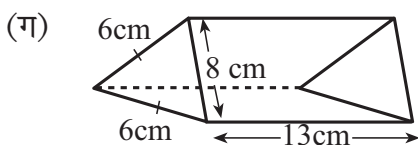
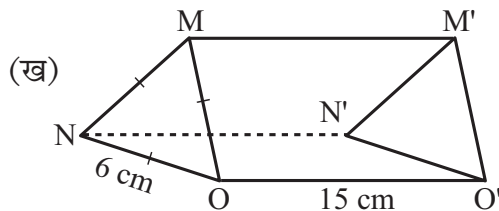
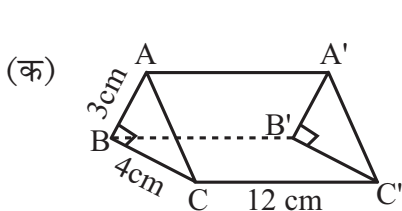

9. The volume of the right triangular prism is 864 m^3 . If the length of side to make right angle of right triangles are 8 cm and 9 cm respectively find the height of prism.
10. The height of the right triangle prism is 30 cm. If the length of the base and perpendicular of the right triangle is 4 cm and 3 cm respectively. Find the areas of rectangular faces.
11. The total surface area of the triangular prism is 660 cm^2 and the base of the prism is a right triangle. The length of the base and hypotenuse of the triangle are 12 cm and 13 cm respectively. Find the height/ length of the prism.
12. The volume of the triangular prism is 480 cm^3 . If the length of the prism is $l \text{ cm}$ and the sides of the base are 4 cm, 13 cm and 15 cm:
- Find the length (l) of the prism.
 - Find the areas of the rectangular faces.
 - Find the total surface area of the prism.
13. The lateral surface area of the triangular prism is 2160 cm^2 . The perimeter of the base is 54 cm and the cross-sectional area is 126 cm^2 . Now find:
- Height of the prism
 - Volume of the prism

14. Santaman plans to construct any one of the following metal boxes to storing rice. Find which of the following box have high capacity to store. Also find which box need less amount of metal and by how much less it is.

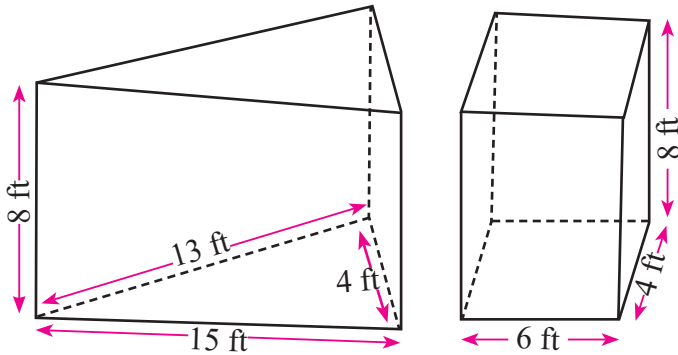

15. **The following type of tent is necessary for a mathematical exhibition hall in a school. They plan for carpeting and making an entry gate using one face of breadth. Then;**

- Find the clothes needed to construct such type of tent.
- Find the area of carpet for carpetting.
- If one exhibition cabin occupied 7m^2 , then how many exhibition cabins can be constructed in this hall?

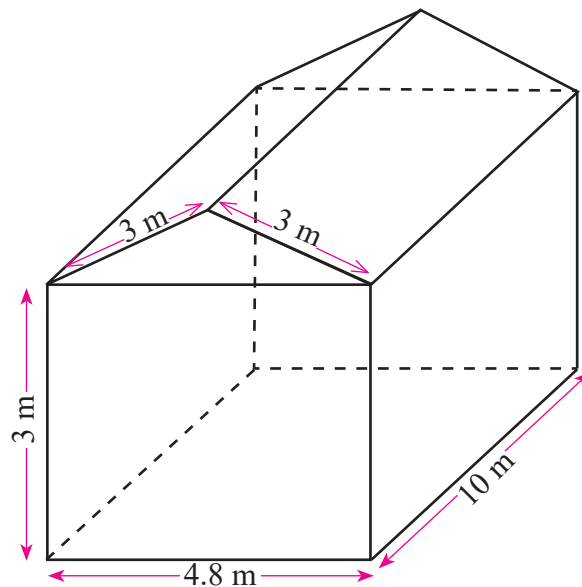

16. A reserve water tank will be constructed in a village for supplying drinking water. One of the following water tank designs is to be selected. Which of the following design is appropriate for construction on the basis of the capacity of the tank and materials for construction?

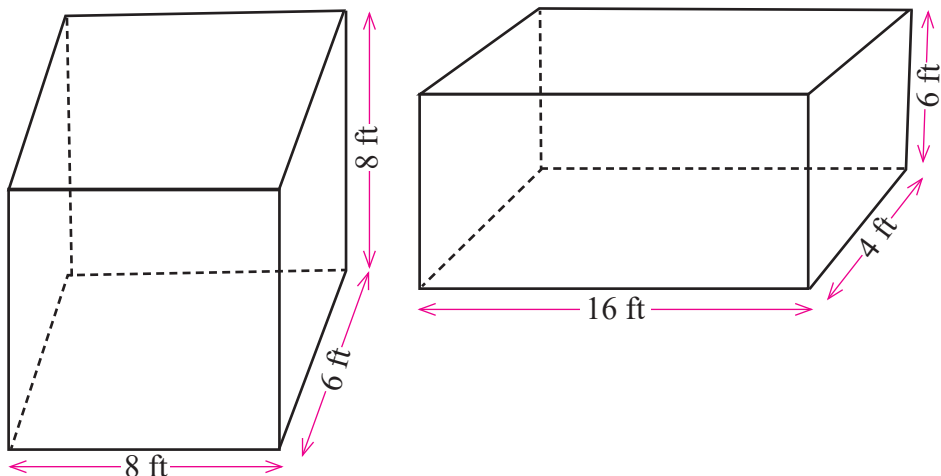

Project Work

1. Collect different models of the prism from your community. Find their measurement of any two objects using the ruler and present the answer to following questions in your class:
 - (a) Find the cross-sectional area of the objects
 - (b) Find the total surface area of the objects
 - (c) Find the volume of the objects.
2. Divide the students of the class into a group of 5/5 students. Construct the triangular prism of different shapes for each group using paper, string, or wood. Find the measurement of each part of the prism find;
 - (a) cross- sectional area.
 - (b) lateral surface area.
 - (c) how many times is the lateral surface area more than its cross-sectional area (in percent)?

Answers

1. 350 cm^3 2. 288 cm^2 3. 255 cm^2
4. (a) $80 \text{ cm}^2, 216 \text{ cm}^2, 376 \text{ cm}^2, 480 \text{ cm}^3$
(b) $25 \text{ cm}^2, 100 \text{ cm}^2, 150 \text{ cm}^2, 125 \text{ cm}^3$
(c) $48 \text{ cm}^2, 180 \text{ cm}^2, 276 \text{ cm}^2, 288 \text{ cm}^2$
(d) $62 \text{ cm}^2, 336 \text{ cm}^2, 460 \text{ cm}^2, 496 \text{ cm}^3$
(e) $24 + 2\sqrt{5} \text{ cm}^2, 220 \text{ cm}^2, 276.94 \text{ cm}^2, 284.72 \text{ cm}^3$
(f) $600 \text{ cm}^2, 3600 \text{ cm}^2, 4800 \text{ cm}^2, 18000 \text{ cm}^3$
5. (a) 30 cm^2 (b) 276 cm^2 (c) 240 cm^3
6. 3000 l
7. 10 cm
8. (a) $6 \text{ cm}^2, 144 \text{ cm}^2, 156 \text{ cm}^2, 72 \text{ cm}^3$
(b) $9\sqrt{3} \text{ cm}, 270 \text{ cm}^2, 301.16 \text{ cm}^2, 135\sqrt{3} \text{ cm}^3$
(c) $8\sqrt{5} \text{ cm}^2, 260 \text{ cm}^2, 295.77 \text{ cm}^2, 104\sqrt{5} \text{ cm}^2$
(d) $39.69 \text{ cm}^2, 480 \text{ cm}^2, 559.38 \text{ cm}^2, 634.98 \text{ cm}^3$
9. $24 \text{ cm},$ 10. 360 cm^2 11. 20 cm
12. (a) 20 cm (b) 640 cm^2 (c) 688 cm^2
13. (a) 40 cm (b) 5040 cm^2
- 14 -16. Show to your teacher.

Lesson 7

Cylinder and Sphere

7.0 Review

Make an appropriate number of groups and take one figure as given below in different groups. Observe these figures and present the conclusion in your class from group discussion on the basis of the following questions:

- How and what type of plane surface are there on the given figures? Count them and write.
- How many vertices and edges are there on given figures? Count them.
- Count how many straight edges are there on given figures?

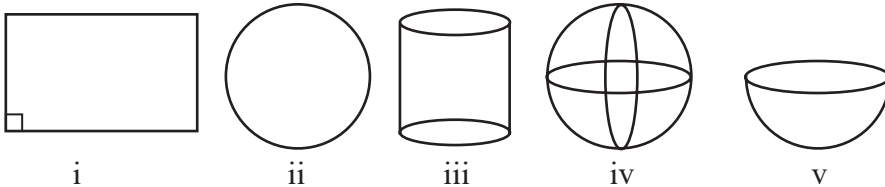

Here,

- In the first figure, there is one rectangular surface. There are four vertices and four straight edges. It is a rectangle.
- In the second figure, there is a circular surface. There are no vertices.
- In the third figure, there are two circular surfaces. There are no edges and one curved surface.
- Similarly, in the fourth figure there are no plane surfaces, edges, and vertices.
- In the fifth figure, there is one plane surface and one curved surface. There are no vertices.

7.1 Cylinder

Surface area of the cylinder

Activity 1

Take one paper-made cylinder having different sizes in each group.

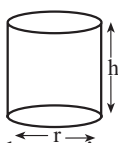

Cut the cylinder vertically as shown in the above figure.

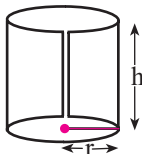

Make a rectangle after cutting the paper cylinder such that the circumference of the circle is converted into length and height into the breadth of the rectangle as shown in the above figure.

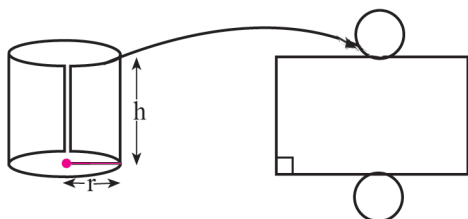

Now, observe the rectangle and cylinder, then discuss the following questions and present them in your class.

- What is the length of the circumference of the circle? Write.
- If the length and breadth are given, then which formula is appropriate to find the area of the rectangle?
- Which part of the cylinder is represented by the area of the rectangle?

The following conclusions can be drawn from the discussion:

The length of the circumference of the circle is the perimeter of the circle.

So, the circumference of the circle = length of the perimeter = $2\pi r$

Likewise, the formula to find the area of the rectangle is $l \times b$.

Here, the area of the rectangle is represented by the curved surface area of the cylinder.

The curved surface area of the cylinder = area of rectangle = $l \times b = 2\pi r \times h = 2\pi rh$ sq. unit.

Again, add the area of two circles of the cylinder on the curved surface area of the cylinder. Are the areas of two circles equal on the cylinder? Yes, they are congruent.

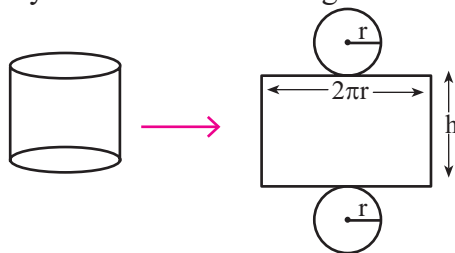

The total surface area of the cylinder = curved surface area of cylinder + area of two circles.

$$= 2\pi rh + 2\pi r^2 \text{ [area of one circle} = \pi r^2\text{]}$$

$$= 2\pi r (h + r)$$

The side figure with one curved surface and two parallel circular bases is called Cylinder.

In cylinder

– Area of the base (A) = πr^2

– Curved Surface Area = $2\pi rh$

– Total Surface Area = $2\pi r(r + h)$

$$= C(r + h) \text{ where, } C = 2\pi r$$

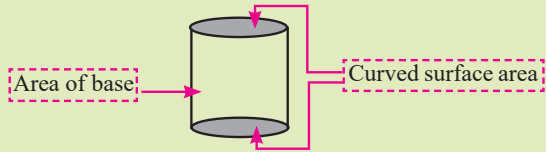

Example 1

Find the curved surface area and total surface area (TSA) of cylinder.

Solution,

Here,

Diameter (d) = 14 cm

Height (h) = 12 cm

Curved surface area of cylinder = ?

Total surface area = ?

Radius (r) = $\frac{d}{2} = \frac{14}{2}$ cm = 7 cm.

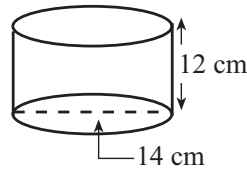

Now,

Curved surface area of cylinder (CSA) = $2\pi rh$

$$= 2 \times \frac{22}{7} \times 7 \times 12$$

$$= 528 \text{ cm}^2$$

Total surface area of cylinder (TSA) = $2\pi r(r + h)$

$$= 2 \times \frac{22}{7} \times 7 (7 + 12) \text{ cm}^2$$

$$= 44 \times 19 \text{ cm}^2$$

$$= 836 \text{ cm}^2$$

Example 2

The curved surface area of a cylindrical box is 1232 cm^2 . If the radius of the base and height of the cylinder are equal, find the area of circular bases and total surface area of cylinder. Also compare curved surface area and the circular base.

Solution,

Here,

$$\text{Curved surface area of cylinder (CSA)} = 1232 \text{ cm}^2$$

$$\text{Radius } (r) = \text{height } (h)$$

$$\text{Area of the circular base} = ?$$

$$\text{Total surface area} = ?$$

We know that,

$$\text{Curved surface area of cylinder} = 2\pi rh$$

$$\text{or, } 1232 = 2 \times \frac{22}{7} \times r \times r \quad [\because r = h]$$

$$\text{or, } \frac{1232 \times 7}{2 \times 22} = r^2$$

$$\text{or, } 196 = r^2$$

$$\text{or, } r = \sqrt{196} = 14$$

$$\therefore \text{Radius } (r) = 14 \text{ cm}$$

$$\text{Now, radius } (r) = \text{height } (h) = 14 \text{ cm}$$

$$\begin{aligned} \text{Area of the circular base} &= 2\pi r^2 \\ &= 2 \times \frac{22}{7} \times (14 \text{ cm})^2 \\ &= 1232 \text{ cm}^2 \end{aligned}$$

Again,

$$\begin{aligned} \text{Total surface area (TSA)} &= \text{Curved surface area} + \text{Area of the circular base} \\ &= (1232 + 1232) \text{ cm}^2 \\ &= 2464 \text{ cm}^2 \end{aligned}$$

Here, curved surface area of cylinder and area of the circular base are equal.

Example 3

The total surface area of cylinder is 2992 cm^2 . If the sum of height and radius is 34 cm , then find:

- Radius of the base of cylinder.
- Area of the base .
- Curved surface area.

Solution,

Total surface area (TSA) = 2992 cm^2

Here, sum of radius and height ($r + h$) = 34 cm

- Radius of the base (r) = ?

By formula,

Total surface area of cylinder (TSA) = $2\pi r(r + h)$

$$\text{or, } 2992 = 2 \times \frac{22}{7} \times r \times 34$$

$$\text{or, } \frac{2992 \times 7}{2 \times 22 \times 34} = r$$

$$\text{or, } r = 14 \text{ cm}$$

- Area of the base (A) = πr^2
 $= \frac{22}{7} \times (14)^2$
 $= 616 \text{ cm}^2$

- Curved surface area = $2\pi rh$
 $= 2 \times \frac{22}{7} \times 14 \times (34 - r)$ [$\because r + h = 34 \text{ cm}$]
 $= \frac{44}{7} \times 14 \times (34 - 14)$
 $= 1760 \text{ cm}^2$

Volume of cylinder

Activity 2

Make an appropriate group in your class. Take cylindrical radish or soft cylindrical solid objects and measure their radius and height.

Cut the cylindrical radish or soft cylindrical solid objects as shown in the following figure and make a cuboid from the pieces of the cylinder.

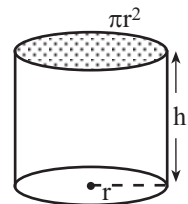

Now, compare the cylinder and cuboid and find the cuboid's length, breadth, and height. Then find the volume of the cuboid.

Here, the length of the cuboid = πr

The breadth of the cuboid = r

Height of the cuboid = h

Volume of the cuboid = $l \times b \times h = \pi r \times r \times h = \pi r^2 h$

Here, the volume of the cylinder = volume of the cuboid

$$= \pi r^2 h$$

$$= \pi r^2 \times h$$

$$= A \times h \text{ [a]ngfsf] cfwf/ j[Q x'g] ePsf] cfwf/sf] If]qkmn (A) = \pi r^2 x'G5 .]$$

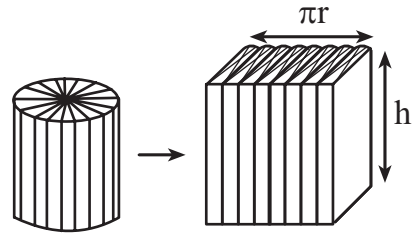

The volume of the cylinder (V) = $\pi r^2 h = A \times h$, where, A is the area of the base of the cylinder

Example 4

If radius of base and height of a cylinder are 14 cm and 20 cm respectively, find volume of the cylinder.

Solution,

Here,

Radius of the base (r) = 14 cm

height of cylinder (h) = 20 cm

Volume of cylinder (V) = ?

By formula,

Volume of cylinder (V) = $\pi r^2 h$

$$= \frac{22}{7} \times (14)^2 \times 20 \text{ cm}^3$$

$$= \frac{22}{7} \times 196 \times 20 \text{ cm}^3$$

$$= 12,320 \text{ cm}^3$$

Example 5

The capacity of cylindrical water tank is 539 l. If the height of cylinder is 1.4 m, then find area of the base.

Solution,

Here,

Capacity of cylinder (Volume of cylinder) (V) = 539 l

$$\begin{aligned} &= \frac{539}{1000} \text{ m}^3 && [\because 1 \text{ m}^3 = 1000 \text{ l}] \\ &= 0.539 \text{ m}^3 \end{aligned}$$

$$\text{height (h)} = 1.4 \text{ m}$$

$$\text{Area of the base (A)} = ?$$

By formula,

$$\text{Volume of cylinder (V)} = A \times h$$

$$\text{or, } 0.539 \text{ m}^3 = A \times 1.4 \text{ m}$$

$$\text{or, } \frac{0.539}{1.4} \text{ m}^2 = A$$

$$\text{or, } A = 0.385 \text{ m}^2$$

$$A = 0.385 \times 100 \times 100 \text{ cm}^2 = 3850 \text{ cm}^2$$

Therefore, area of base of cylinder (A) = 3850 cm²

Example 6

Rajan sold the soybean putting them into paper pots as shown in the above figures. The diameter of pot A is 14 inches and the height is 6 inches. Likewise, the radius of pot B is

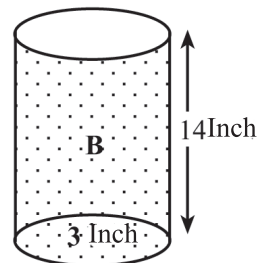
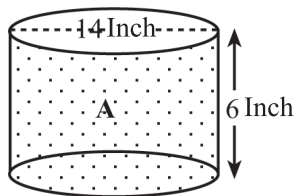

3 inches, and the height is 14 inches. Saroj and Vishal go to the market to buy soybean. At that time Saroj said the quantity of soybean on both pots is equal, so the price of both pots must be equal. Again, Bishal said the quantity of soybean on both pots is not equal, so the price of both pots may not be equal. Find, who is correct and who is wrong on the basis of their arguments.

Solution,

Here, Both the pictures given above are cylinder

In cylinder A

diameter (d) = 14 inch

height (h_1) = 6 inch

Now, Radius (r_1) = $\frac{d}{2} = \frac{14}{2}$ inch = 7 inch

Volume of cylinder A (V_1)

$$= \pi r_1^2 h_1$$

$$= \frac{22}{7} \times (7)^2 \times 6$$

$$= 924 \text{ cubic inch}$$

Similarly, In cylinder B

radius (r) = 3 inch

height (h_2) = 14 inch

Volume of cylinder B (V_2)

$$= \pi r_2^2 h_2$$

$$= \frac{22}{7} \times (3)^2 \times 14 \text{ cubic inch}$$

$$= 396 \text{ cubic inch}$$

Among them Bishal is correct because volume of cylinder A is more than B. So, the rate of soyabean present inside A must be more than that of B.

Exercise 7.1

1. If radius and height of cylinder is x cm and y cm:

- (a) Circumference of base b) Area of the base
- (c) Curved surface area d) Total surface area
- (e) Volume

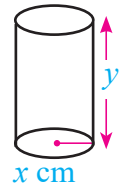

- 2. If radius of cylinder is x cm and height is y cm, then find curved surface area and volume of the cylinder.
- 3. The circumference of the base of a cylinder is c cm and height h cm. Find curved surface area of the cylinder.
- 4. Find the volume of the cylinder of area A sq. feet and height h feet.
- 5. If the radius of the cylinder is r unit and height h unit, find:
 - (a) Volume
 - (b) Curved surface area
 - (c) Plane surface area
 - (d) Total surface area
- 6. The circumference of the base of a cylinder is C unit and the sum of radius and height is S unit, find the total surface area of the cylinder.

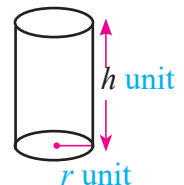

7. Find the plane surface area, curved surface area, and volume of the following prism:

- (a) radius (r) = 7 cm and height (h) = 5 cm
- (b) radius (r) = 3.5 m and height (h) = 6 m
- (c) radius (r) = 2 ft and height (h) = 7 ft

8. Find the area of the base, plane surface area, curved surface area, total surface area, and volume of the following prism:

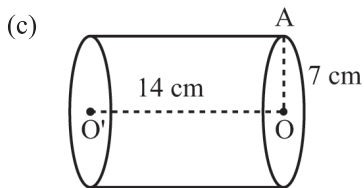
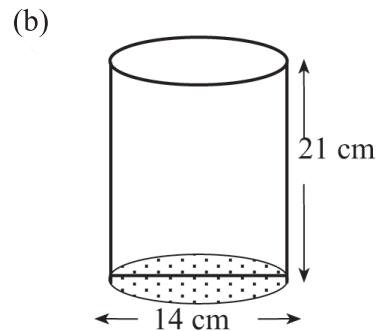
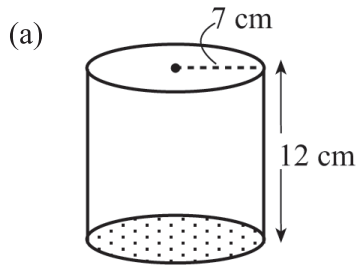

$OA = 7 \text{ cm}$
 $OO' = 14 \text{ cm}$

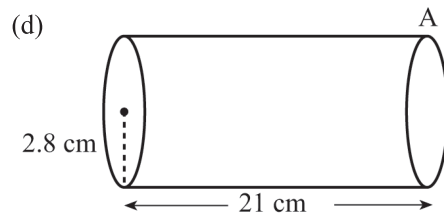

9. If the circumference of the base of a cylinder is 176 cm, and the height is 30 cm, find the curved surface area and total surface area of the cylinder.

10. If the circumference of the base of a cylinder is 88 cm, and the sum of radius and height is 24 cm, then find:

- (a) Area of the base. (b) Curved surface area sum of radius and height is 24 cm
 - (c) Total surface area (d) Volume
11. If the sum of the radius and height of the cylinder is 34 cm, and the total surface area is 2992 cm^2 then find the volume of the prism.
12. The sum of the diameter and height of the cylinder is 28 cm, and the curved surface area is 462 cm^2 , find the total surface area.
13. The ratio of the radius of the base and height of a cylinder is 1:3 and their sum is 56 cm, find the curved surface area and total surface area of the cylinder.

14. If the ratio of the radius of the base and height of a cylinder is 1:3 and its curved surface area is 924 cm^2 , find the area of the base and volume of the cylinder.
15. The curved surface area of a cylindrical log is three times more than the area of the base. If the sum of the radius of the base and height of the log is 25 cm, find the volume of the cylindrical log.
16. The inner circumference of the following cylindrical pots are 21 cm and 14 cm and the heights are 14 cm and 21 cm respectively. Find how much water can be filled in these pots.

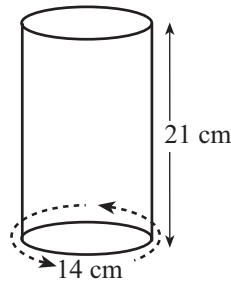
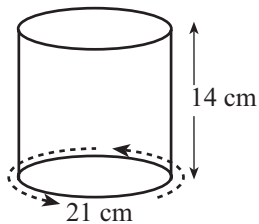

17. The students in a school are requested to participate in the competition of making cylindrical pencil cases. The radius and height of each pencil case must be 3 cm and 10.5 cm respectively. If 35 students participated in the competition, find how much cardboard paper was used in that competition.
18. A hospital provides mushroom soup on a cylindrical glass with a 7 cm radius for his patient each day. If the mushroom soup filled the 6 cm height of the glass, find how much soup is prepared by the hospital daily for their 250 patients.
19. Mankumari planned to prepare a cylindrical bucket from the mat to store crops. If the breadth of the mat is 1.1 meter, then how long mat is needed to store 1.4 cu. meter crops.

Project Work

Sit in the appropriate number of groups. Search different cylindrical objects like; water tanks, drums, buckets to store crops, glasses, etc and measure their radius of the base and height. Find the curved surface area, total surface area, and volume of each object and present the result in your class.

Answers

- 1-6. Show to your teacher.
7. (a) 308 cm^2 , 220 cm^2 , 770 cm^3
(b) 77 cm^2 , 132 cm^2 , 231 cm^3
(c) 25.14 ft^2 , 88 ft^2 , 88 ft^3
8. (a) 154 cm^2 , 308 cm^2 , 528 cm^2 , 836 cm^2 , 1848 cm^3
(b) 154 cm^2 , 308 cm^2 , 924 cm^2 , 1232 cm^2 , 3234 cm^3
(c) 154 cm^2 , 308 cm^2 , 616 cm^2 , 924 cm^2 , 2156 cm^3
(d) 2464 cm^2 , 4928 cm^2 , 3696 cm^2 , 8624 cm^2 , 51744 cm^3
9. 5288 cm^2 , 10208 cm^2
10. (a) 616 cm^2 (b) 880 cm^2 (c) 2112 cm^2 (d) 6160 cm^3
11. 12320 cm^3 12. 539 cm^2 jf 1617 cm^2
13. 3696 cm^2 , 4928 cm^2 14. 154 cm^2 , 3234 cm^3
15. 4714.28 cm^3 16. 0.162635 l
17. 7919.8 cm^2 18. 57.75 l
19. 4 m

7.2.1 Surface area of sphere

What do you mean by sphere? Is it like a circle? Can we make a circle into our copy? Yes, we can construct a circle in our copy because it is a closed plane figure made by joining the points' equidistance from a fixed point. The fixed point is called the center of the circle and the equal distance is called the radius of the circle. Balls and marbles are the spheres.



Activity 1

Make an appropriate number of groups and take a rubber ball for each group.

Thumb a pin at any point on the surface of the ball. Cover the ball by thread with the help of a pin and glue on the overall surface of the ball. Now, remove the thread from the ball.

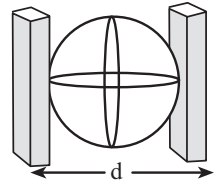

Find the diameter of the rubber ball. For this, put the ball in the middle of two pieces of cardboard paper as shown in the above figure. The distance between two pieces of cardboard paper is the diameter of the sphere. The radius is half of the diameter. Using the radius, construct four circles in your copy and paste the thread on the surface of all circles.

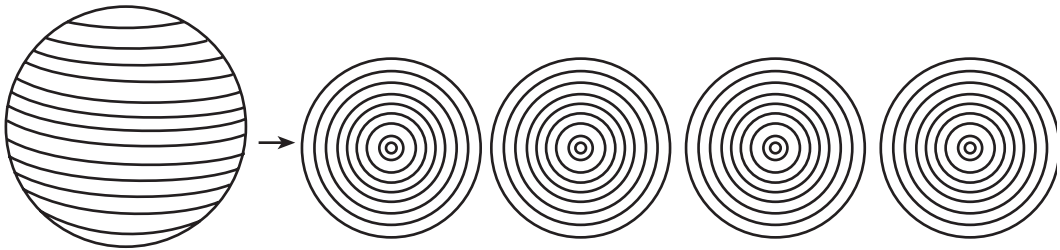

Present the result of the above Activity in your class.

Here, the thread covered by the surface of the ball also covers the surface of four circles where the radius of all circles is equal to the radius of the sphere.

So, the surface area of the sphere = area of the four circles.

$$= \pi r^2 + \pi r^2 + \pi r^2 + \pi r^2$$

$$= 4\pi r^2$$

Therefore, the surface area of the sphere (A) = $4\pi r^2$, where r is the radius of the sphere.

7.2.2 Surface area of hemisphere

Activity 2

Make necessary groups on the basis of students' numbers. Take one lemon for each group. Cut the lemon into two equal parts from its center and discuss the following questions:

- What are these two pieces called?
- How many surfaces are there?
- What is the curved surface area of the hemisphere?
- What is the total surface area of the hemisphere?

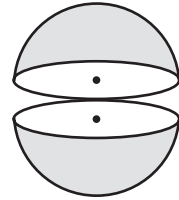

The two equal parts of the sphere made by cutting from its center are called the hemispheres. There are two surfaces in a hemisphere. They are called curved surfaces and plane surfaces. The curved surface area of the hemisphere is half of the curved surface area of the sphere.

$$\text{The curved surface area of the hemisphere} = \frac{1}{2} \times 4\pi r^2 = 2\pi r^2$$

Likewise, the total surface area of the hemisphere

$$= \text{curved surface area} + \text{plane surface area.}$$

$$= 2\pi r^2 + \pi r^2 \quad [\because \text{the plane surface area is the area of the circle}]$$

$$= 3\pi r^2$$

Where r is the radius of the hemisphere which is equal to the radius of the sphere.

Example 1

Find the surface area of a sphere having radius 3.2 cm.

Solution,

Here, radius of sphere (r) = 3.2 cm

Surface area of sphere = ?

From formula,

$$\begin{aligned} \text{Surface area of the sphere (A)} &= 4\pi r^2 \\ &= 4 \times \frac{22}{7} \times (3.2 \text{ cm})^2 \\ &= 128.73 \text{ cm}^2 \end{aligned}$$

Example 2

If the circumference of the great circle of a water tank is 22 ft, calculate the surface area of water tank. ($\pi = \frac{22}{7}$)

Solution,

Here, circumference of the great circle (C) = 22 ft

Surface area of the sphere =?

We know that,

a) Circumference of the circle (C) = $2\pi r$

$$22 \text{ ft} = 2 \times \frac{22}{7} \times r$$

$$\text{or, } \frac{22 \times 7}{2 \times 22} \text{ ft} = r$$

$$\text{or, } r = 3.5 \text{ ft} = 3 \text{ ft } 6 \text{ inch}$$

b) Surface area of the sphere (A)

$$= 4\pi r^2 = 4 \times \frac{22}{7} \times (3.5)^2$$

$$= 154 \text{ ft}^2$$

So, surface area of the sphere (A) = 154 ft²

Example 3

Find the curved surface area, total surface area and plain surface area of a hemisphere with diameter 28 cm.

Solution,

Here, diameter of the hemisphere (d) = 28 cm

Radius of hemisphere (r) = 14 cm

Plain surface area =?

Curved surface area =?

Total surface area =?

Using formula,

a) Plain surface area = $\pi r^2 = \frac{22}{7} (14 \text{ cm})^2 = 616 \text{ cm}^2$

b) Curved surface area (CSA) = $2\pi r^2 = 2 \times \frac{22}{7} \times (14 \text{ cm})^2 = 1232 \text{ cm}^2$

c) Total surface area (TSA) = $3\pi r^2 = 3 \times \frac{22}{7} \times (14 \text{ cm})^2 = 1848 \text{ cm}^2$

7.2.3 Volume of sphere

Activity 3

Sit into the appropriate number of groups. In each group, take a cylinder having a diameter of the base equal to the diameter of the sphere. The diameter and height of the cylinder must be equal. Now, fill the water in the cylinder and note down the quantity of the water in the cylinder using a measuring cylinder.

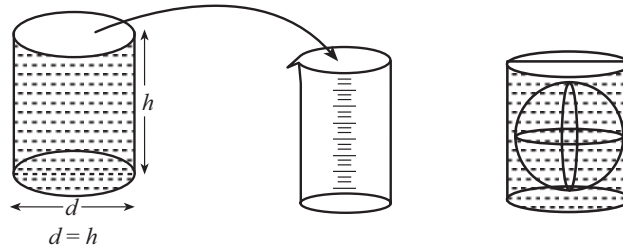

Now put the sphere into the cylinder as shown in the picture. Then put the water in the cylinder with the sphere from the measuring cylinder. Again note down the quantity of the water in the cylinder using a measuring cylinder. Now compare the quantity of water with and without putting the sphere in the cylinder and present the result in the class.

Here, the quantity of the water by putting the sphere in the cylinder is one-third of the water without putting the sphere in the cylinder. The two-third of the water was replaced by the sphere.

$$\begin{aligned}\text{Volume of the sphere (V)} &= \frac{2}{3} \text{ volume of cylinder} \\ &= \frac{2}{3} (\text{base area of the cylinder} \times \text{height}) \\ &= \frac{2}{3} (\pi r^2 \times h) = \frac{2}{3} (\pi r^2 \times d) && [\because d = h] \\ &= \frac{2}{3} \pi r^2 \times 2r = \frac{4}{3} \pi r^3\end{aligned}$$

$$\text{Volume of cylinder (V)} = \frac{4}{3} \pi r^3 \text{ where } r = \text{radius of the sphere.}$$

7.2.4 Volume of hemisphere

Activity 4

Does the volume of hemisphere is half of the volume of sphere? Discuss in your group.

Here, volume of hemisphere is half of the volume of sphere.

$$\begin{aligned}\text{Volume of hemisphere (V)} &= \frac{1}{2} \left(\frac{4}{3} \pi r^3 \right) \\ &= \frac{2}{3} \pi r^3\end{aligned}$$

Example 4

Find the volume of sphere with diameter 21 cm:

Solution,

Here, diameter (d) = 21 cm

volume of sphere (V) = ?

$$\begin{aligned}\text{Now, radius (r)} &= \frac{d}{2} \\ &= \frac{21}{2} \text{ cm}\end{aligned}$$

Now,

$$\begin{aligned}\text{Volume of sphere (V)} &= \frac{4}{3} \pi r^3 \\ &= \frac{4}{3} \times \frac{22}{7} \times \left(\frac{21}{2} \right)^3 \text{ cm}^3 \\ &= 4851 \text{ cm}^3\end{aligned}$$

So, Volume of sphere (V) = 4851 cm³

Example 5

The diameter of metallic sphere is 4.2 cm. If $1 \text{ cm}^3 = 8.9 \text{ gm}$, find the mass of the sphere:

Solution,

Here, diameter of sphere (d) = 4.2 cm

$$1 \text{ cm}^3 = 8.9 \text{ gm}$$

mass of sphere = ?

$$\text{Now, radius } (r) = \frac{d}{2} = \frac{4.2}{2} \text{ cm} = 2.1 \text{ cm}$$

$$\begin{aligned} \text{By formula, volume of sphere } (V) &= \frac{4}{3}\pi r^3 \\ &= \frac{4}{3} \times \frac{22}{7} \times (2.1)^3 \text{ cm}^3 \\ &= 38.808 \text{ cm}^3 \end{aligned}$$

We know that,

$$1 \text{ cm}^3 = 8.9 \text{ gm}$$

$$38.808 \text{ cm}^3 = 8.9 \times 38.808 \text{ gm}$$

$$= 345.39 \text{ gm}$$

$$\therefore \text{Mass of the sphere (mass)} = 345.39 \text{ gm}$$

Example 6

The radius of a hemispherical urn is 3.5 cm. If the urn is filled with water completely, find the volume of water.

Solution,

Here, radius of the hemisphere (r) = 3.5 cm

volume of hemisphere = volume of water

By formula,

volume of the waater in urn

$$\begin{aligned} (V) &= \frac{2}{3}\pi r^3 \\ &= \frac{2}{3} \times \frac{22}{7} \times (3.5)^3 \text{ cm}^3 = 89.8 \text{ cm}^3 \end{aligned}$$

So, volume of water (V) = 89.8 cm³

Example 7

The radius of the sphere and hemisphere with equal areas are r_1 and r_2 respectively. Find the ratio of their radius.

Solution,

Here, radius of sphere = r_1

radius of hemisphere = r_2

$$\frac{r_1}{r_2} = ?$$

We know that,

Surface area of sphere (A_1) = $4\pi r_1^2$

Surface area of hemisphere (A_2) = $3\pi r_2^2$

By question,

$$A_1 = A_2$$

$$4\pi r_1^2 = 3\pi r_2^2$$

$$\text{or, } \frac{r_1^2}{r_2^2} = \frac{3\pi}{4\pi}$$

$$\text{or, } \frac{r_1}{r_2} = \sqrt{\frac{3}{4}} = \frac{\sqrt{3}}{2}$$

$$\therefore r_1 : r_2 = \sqrt{3} : 2$$

Example 8

Three solid metallic spheres with ratio 1 cm, 6 cm and 8 cm are melted and made a sphere. Find the radius of large sphere.

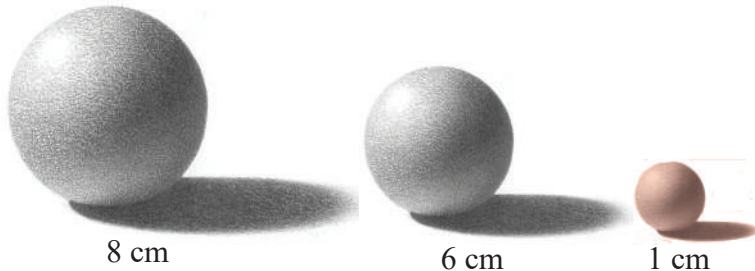

Solution,

Here, radius of first sphere (r_1) = 1 cm

radius of second sphere (r_2) = 6 cm

radius of third sphere (r_3) = 8 cm

Suppose, V_1, V_2, V_3 are the volume of three small sphere and V is the volume of new sphere.

$$V = V_1 + V_2 + V_3$$

Let r is the radius of new sphere, then

$$\frac{4}{3}\pi r^3 = \frac{4}{3}\pi r_1^3 + \frac{4}{3}\pi r_2^3 + \frac{4}{3}\pi r_3^3$$

or, $\frac{4}{3}\pi r^3 = \frac{4}{3}\pi (r_1^3 + r_2^3 + r_3^3)$

or, $r^3 = [(1)^3 + (6)^3 + (8)^3] \text{ cm}^3$

or, $r^3 = (1 + 216 + 512) \text{ cm}^3$

or, $r^3 = 729 \text{ cm}^3$

or, $r = \sqrt[3]{729} \text{ cm}$

or, $r = 9 \text{ cm}$

So, radius of new sphere (r) = 9 cm

Exercise 7.2

1. If the radius of a sphere is x unit, then find:

- | | |
|---------------------------------------|-------------------------------|
| (a) Surface area of the sphere. | (b) Volume of the sphere |
| (c) Circumference of the large circle | (d) Area of the large circle. |

- If the area of the large circle of a sphere is a sq. unit, then find the surface area of the sphere.
- If the surface area of a sphere is $4x$ sq. unit, find the total surface area of one hemisphere formed from the sphere.
- If the area of the large circle is y sq. unit, find the total surface area of the sphere.

5. If the diameter of a sphere is d cm, find:

- | |
|---------------------------------------|
| (a) Circumference of the large circle |
| (b) Area of the large circle |
| (c) Volume of the sphere. |
| (d) Surface area of the sphere |
- Find, how many materials (TPE lather - Thermoplastic Elastomer Lather) are needed to make a volleyball of the size given in the picture.



volleyball
 $r = 10.5 \text{ cm}$

7. Kazakhstan Pavilion and Science of Noor Alam, Kazakhstan is in a spherical shape. A science exhibition of 100 countries was organized in this hall in 2017. If the diameter of the spherical hall is 80 meters and the outer surface of the hall is covered by glass, find the surface area of the hall covered by the hall.

8. Find the surface area and volume of the given spheres and hemispheres:

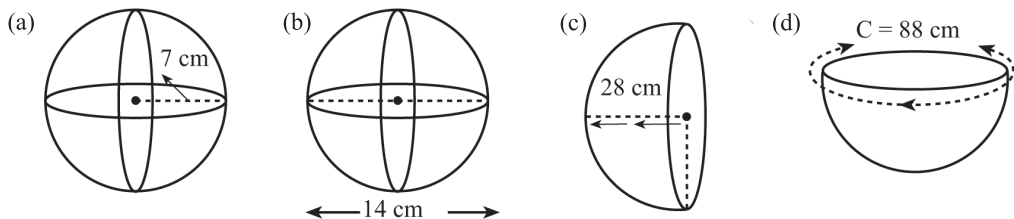

9. The diameter of a spherical ball is 35 cm, find the surface area and volume of the ball.
10. The circumference of the large circle of a hemisphere is 44 cm. Find the total surface area of the hemisphere.
11. The total surface area of the spherical solid object is 2464 cm^2 . Find the diameter of the object.
12. If the volume of a sphere is 38808 m^3 . Find its radius.
13. (a) If the total surface area of the hemisphere is $243\pi \text{ cm}^2$, find its volume.
(b) If the volume of a sphere is $2304\pi \text{ cm}^3$, find the surface area of the sphere.
14. The diameter of the moon is approximately one-fourth of the diameter of the sun. Find the ratio of their surface areas.
15. The ratio of surface area and volume of a sphere is 1:3. Find the diameter and volume of the sphere.
16. If the radius of the tennis ball is doubled on its original radius, find the total changes in their volume.
17. If the radius of a spherical balloon is increased from 7cm to 14cm, find the ratio of the surface areas.
18. Three spheres with radius of 2 cm, 12 cm, and 16 cm respectively are melted and formed into a single sphere. Find the diameter of the new sphere.
19. The total surface area of a hemispherical object is $243\pi \text{ cm}^2$, find the length of the perimeter and volume of the object.

Project Work

1. Take a plastic ball and cut it from the middle such that it would be divided into two equal parts. Now, construct a cylinder of diameter and height equal to the diameter of the ball using thick paper. Fill the water into the hemispherical ball and pour the water into the cylinder. Find out how many times the cylinder is filled with the water. Find the ideas related to the formula of volume of sphere and hemisphere on the basis of the formula of the cylinder.
2. Take a spherical lemon. Cut the lemon into two equal parts. Trace four circles using the great circle of hemispherical lemon. Now paste the cover of the lemon on the circle. Present the conclusion of these Activity in your class.
3. Make different groups in appropriate numbers. Collect the football, volleyball, and basketball from your school for each group. Find the total surface area and volume of the football, volleyball, and basketball. Present the result in your class and make a report including the suggestions of the class.

Answers

- 1-5. Show to your teacher.
6. 1386 cm^2
7. 20114.29 m^2
8. (a) 616 cm^2 , 1437.34 cm^3
(b) 616 cm^2 , 1437.34 cm^3
(c) 7392 cm^2 , 45994.67 cm^3
(d) 1848 cm^2 , 5749.34 cm^3
9. 3850 cm^2 , 22458.34 cm^3
10. 462 cm^2 11. 28 cm
12. 21 m
13. (a) 1527.43 cm^3
- (b) 1810.29 cm^2 or $576\pi \text{ cm}^2$
14. $16:1$
15. 18 cm , 3054.85 cm^3
16. 8 times greater
17. $1:4$ 18. 36 cm
19. 56.57 cm , 1527.43 cm^3

Miscellaneous Exercise

1. Find the areas of the following triangles:

a)

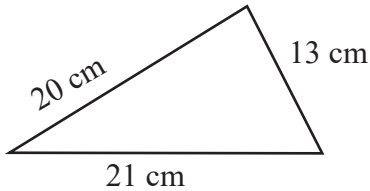

b)

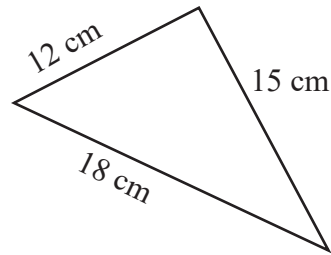

2. A businessman made a pattern on the floor of a living room of his house as shown in the given figure. Twenty-eight triangular tiles of sides 9cm, 12cm, and 15cm were used to make such pattern. Find out the total cost of laying tiles if the per-unit centimeter cost of the tile is 10 paisa.

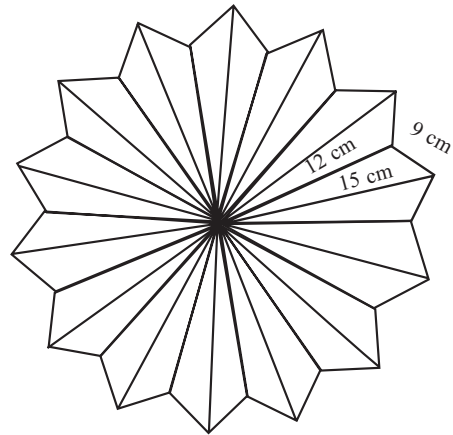

3. In a solid cylinder, three times the curved surface area is equal to two times the total surface area of the same cylinder. If the curved surface area of the cylinder is 616 cm^2 , find the circumference of the base and height of the cylinder.
4. The difference between the total surface area and curved surface area of a cylinder is 308, find the diameter of the base and perimeter of the cylinder
5. The plane surface area of a cylinder is 1232 cm^2 . If the radius of the base is equal to the height of the cylinder, then find the volume of the cylinder.
6. The total surface area of a sphere is 616 cm^2 , find the diameter of the great circle of the given sphere.
7. Find the total surface area of the given hemispherical solid object.
8. There are one door of size $2 \text{ m} \times 1.5 \text{ m}$ and four windows of size 1 meter \times 1.5 meters in a room of size 12 meters and 10 meters. The total cost for coloring on the four walls at the rate of Rs 180 is Rs.30,060, find the height of the rooms.

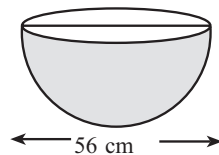

9. Find total surface area and volume of the given prisms:

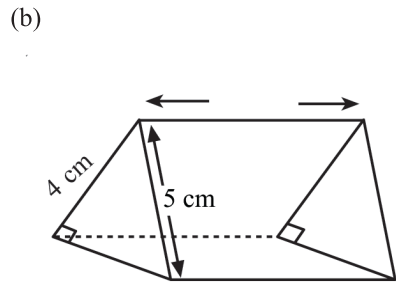
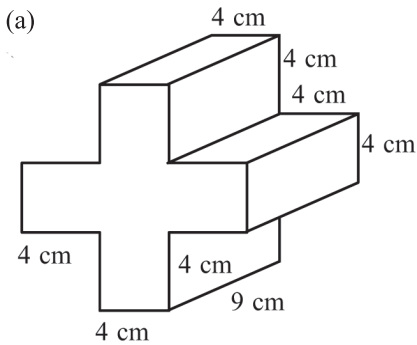

10. Find the cost of colouring the following solid objects, if the cost of colouring per sq. centimeter is Rs. 180:

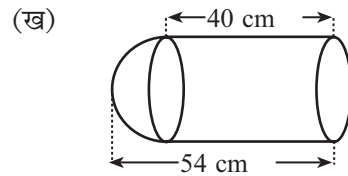
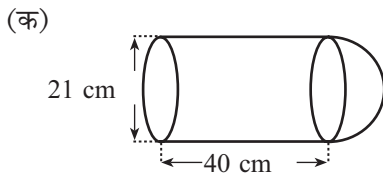

Answers

- | | | |
|--|--|------------------------|
| 1. (a) 126 cm^2 | (b) 89.29 cm^2 | 2. Rs. 15,120 |
| 3. 44 cm, 14 cm | 4. 14 cm, 44 cm | 5. 8624 cm^3 |
| 6. 14 cm | 7. 7392 cm^3 | 8. 4 m |
| 9. (a) 592 cm^2 , 720 cm^3 | (b) 132 cm^2 , 60 cm^3 | |
| 10. (a) Rs. 662310 | (b) Rs. 966240 | |

8.1 Review

Answer the given questions discussing with your friends:

- (i) What are the next terms in the given pattern?
 - (a) 2, 4, 6, 8, ...
 - (b) 1, 4, 9, 16, ...
- (ii) The length of the perimeter of the wheels of a cycle is 1.5 m. the distance covered by the wheels in each round up to the 6th round is given below. Now, find the distance covered by the wheels on the 7th round.
1.5 m, 3 m, 4.5 m, 6 m, 7.5 m, 9 m, ...
- (iii) Pemba deposits Rs 500 at the interest rate of 10% annually in a bank. The interest at the end of the first, second, third, and fourth-year is given below. Find the interest of the fifth and sixth years by observing the following pattern.
Rs. 50, Rs. 100, Rs. 150, Rs. 200, ...

Observe the relation between the numbers, the difference between the two terms, and the pattern of the numbers.

8.1.1 Introduction to sequence

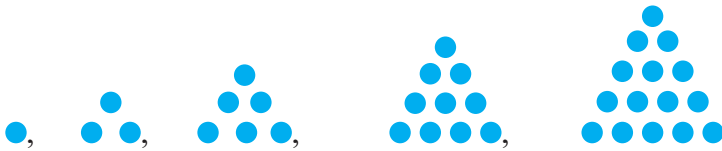

The above pattern of marbles is prepared by class IX students in a playground.

- (a) Find the number of marbles in each pattern
- (b) Add another new pattern.
- (c) Do these patterns present a fixed sequence? Discuss in group.

If the group of numbers is presented in a fixed pattern, then it is called a sequence.

The number of marbles in the above patterns 1, 3, 6, 10, 15, ... is an example of the sequence.

If the number of terms in a sequence is fixed, then it is called a finite sequence and if the terms are not fixed, then it is called an infinite sequence. In other words, the

sequence is said to be finite if we can calculate the last term and infinite if we can not calculate its last term.

Here, 1, 3, 5, 7, ..., 15 is finite sequence, and 10, 20, 30, 40, ... is infinite sequence.

Example 1

Find out the 5th and 6th term in a sequence of 4, 7, 10, 13, ...

Solution,

Here 4, 7, 10, 13, ... the sequence of the numbers gives a special pattern; where the coming number is more than 3 than it's previous number. So, the 5th and 6th terms are $13 + 3 = 16$ and $16 + 3 = 19$ respectively.

8.1.2 General term

Activity 1

4, 8, 12, 16, ... is a sequence. Now discuss on the following questions:

What is the 25th term of the sequence?

What is the 99th term of the sequence?

Activity 2

What is the n^{th} term of the following sequence when n stated from 1? Discuss.

Sequence	formula for n^{th} term
1, 3, 5, 7, 9, 11, ...	
1, 4, 9, 16, 25, ...	
1, 8, 27, ...	

The n^{th} term of any sequence is calculated by observing the terms of sequence. The n^{th} term is called General term of the sequence.

Example 2

Find the n^{th} term of the given sequence:

7, 11, 15, 19, 23, ...

Solution,

Here, Observe the differences between each terms of the sequence:

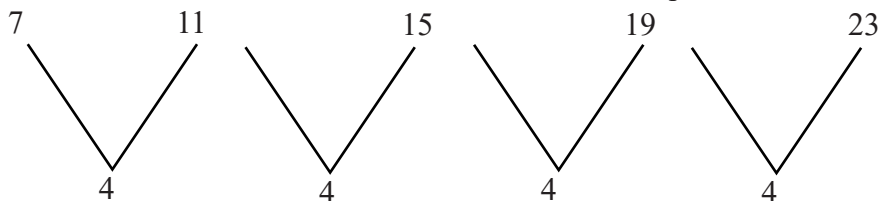

The common difference between the terms is 4, so the n^{th} term is in the form of $4n$. Observe the following pattern:

$$\text{First term } (t_1) = 7 = 4 \times 1 + 3 = 7$$

$$\text{Second term } (t_2) = 11 = 4 \times 2 + 3 = 11$$

$$\text{Third term } (t_3) = 15 = 4 \times 3 + 3 = 15$$

$$\text{Fourth term } (t_4) = 19 = 4 \times 4 + 3 = 19$$

$$\text{Fifth term } (t_5) = 23 = 4 \times 5 + 3 = 23$$

\vdots \vdots

$$n^{\text{th}} \text{ term } (t_n) = 4 \times n + 3 = 4n + 3$$

\therefore To observe the given pattern, we found n^{th} term $t_n = 4n + 3$.

Example 3

If the general term $(t_n) = 2n-1$, find the first five terms of the sequence; where n represent the natural number.

Solution,

Here, $t_n = 2n-1$

Put $n = 1$ we have, $t_1 = 2 \times 1 - 1 = 2 - 1 = 1$

Put $n = 2$ then, $t_2 = 2 \times 2 - 1 = 4 - 1 = 3$

Put $n = 3$ then, $t_3 = 2 \times 3 - 1 = 6 - 1 = 5$

Put $n = 4$ then, $t_4 = 2 \times 4 - 1 = 8 - 1 = 7$

Put $n = 5$ then, $t_5 = 2 \times 5 - 1 = 10 - 1 = 9$

\therefore The given sequence of the numbers is 1, 3, 5, 7, 9.

Exercise 8.1

1. Find two terms more in each sequences:

- | | |
|-----------------------------|--|
| (a) 1, 2, 3, 4, ... | (b) 2, 4, 6, 8, 10, ... |
| (c) 5, 10, 15, 20, 25, ... | (d) 1, 2, 4, 8, 16, ... |
| (e) 22, 20, 18, 16, 14, ... | (f) -8, -6, -4, ... |
| (g) 2, 5, 9, 14, 20, ... | (h) $\frac{1}{3}, \frac{4}{5}, \frac{7}{7}, \frac{10}{9}, \dots$ |

2. Find the general terms (t_n) of the following sequences:

- | | |
|--|---|
| (a) 4, 6, 8, 10, ... | (b) 7, 11, 15, 19, 23, ... |
| (c) 2, 6, 10, 14, 18, ... | (d) 25, 22, 19, 16, ... |
| (e) $\frac{1}{3}, \frac{4}{5}, \frac{7}{7}, \frac{10}{9}, \dots$ | (f) $\frac{2}{7}, \frac{5}{8}, \frac{8}{9}, \frac{11}{10}, \dots$ |
| (g) 40, 38, 36, 34, ... | (h) $\frac{2}{5}, \frac{4}{8}, \frac{6}{11}, \frac{8}{14}, \dots$ |

3. From given general terms, find first 5 terms and present it in the form of sequenc when ' n ' represent the natural number:

- | | |
|------------------------------|--------------------------|
| (a) $t_n = 2n + 4$ | (b) $t_n = 3n - 1$ |
| (c) $t_n = 3^n$ | (d) $t_n = n^2 - 1$ |
| (e) $t_n = (-1)^n \cdot n^2$ | (f) $t_n = n^2 + 2n + 3$ |
| (g) $t_n = 3n^2 - 5$ | |

4. Observe the following patterns and find two patterns more then find the general term (t_n):

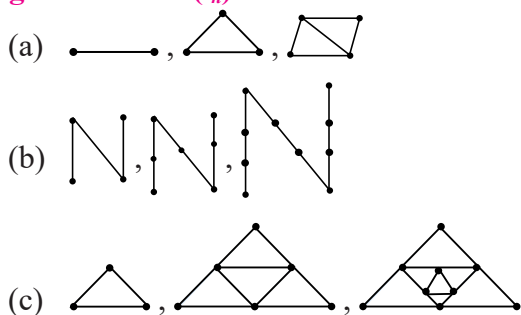

Answers

- (a) 5, 6 (b) 12, 14 (c) 30, 35 (d) 32, 64 (e) 12, 10
(f) -2, 0 (g) 27, 35 (h) $\frac{13}{11}, \frac{16}{13}$
- (a) $2n + 2$ (b) $4n + 3$ (c) $4n - 2$ (d) $28 - 3n$ (e) $\frac{3n - 2}{2n + 1}$
(f) $\frac{3n - 1}{n + 6}$ (g) $42 - 2n$ (h) $\frac{2n}{3n + 2}$
- (a) 6, 8, 10, 12, 14, ... (b) 2, 5, 8, 11, 14, ...
(c) 3, 9, 27, 81, 243, ... (d) 0, 3, 8, 15, 24, ...
(e) -1, 4, -9, 16, -25, ... (f) 6, 11, 18, 27, 28, ...
(g) -2, 7, 22, 43, 70, ...
- Show your teacher.

8.2 Introduction to series

Discuss the following questions in a group

- What is the sum of the first five terms of the series whose general term is $(t_n) = 2n + 1$?
- Can we represent these five terms by $t_1 + t_2 + t_3 + t_4 + t_5$? What do is it called?

If all the terms of any sequence is expressed in the form of summation, then it is called series. It is represented by the symbol ' Σ ' (Sigma or Summation). E.g. Here, 7, 11, 15, 19, 23, ... is a sequence. The corresponding series is $7 + 11 + 15 + 19 + 23 + \dots$

Example 1

If the general term of the sequence is $(t_n) = 2n + 3$:

- Find the value of first five terms
- Find the sum of first five terms:
- Write this sequence using the sign ' Σ '.

Solution,

(a) Put the value of $n = 1, 2, 3, 4, 5$ in the general term $(t_n) = 2n + 3$, we get

$$t_1 = 2 \times 1 + 3 = 2 + 3 = 5$$

$$t_2 = 2 \times 2 + 3 = 4 + 3 = 7$$

$$t_3 = 2 \times 3 + 3 = 6 + 3 = 9$$

$$t_4 = 2 \times 4 + 3 = 8 + 3 = 11$$

$$t_5 = 2 \times 5 + 3 = 10 + 3 = 13$$

(b) $t_1 + t_2 + t_3 + t_4 + t_5$
 $= 5 + 7 + 9 + 11 + 13$
 $= 45$

(c) We can write the series using sign ' Σ ' by $\sum_{n=1}^5 2n + 3$ x'G5 .

Example 2

Find the value of:

$$\sum_{n=1}^6 (2^n + 1)$$

Solution,

Here, $\sum_{n=1}^6 (2^n + 1) = (2^1 + 1) + (2^2 + 1) + (2^3 + 1) + (2^4 + 1) + (2^5 + 1) + (2^6 + 1)$
 $= (2 + 1) + (4 + 1) + (8 + 1) + (16 + 1) + (32 + 1) + (64 + 1)$
 $= 3 + 5 + 9 + 17 + 33 + 65$
 $= 132$

Exercise 8.2

1. (a) Define sequence with a suitable example.
(b) What is the difference between sequence and series.
2. **Find sequence and series from the given expressions:**

(a) 3, 6, 9, 12, 15, ...	(b) 2 + 4 + 6 + 8 + 10 + ...
(c) 4, 2, 1, $\frac{1}{2}$, $\frac{1}{4}$	(d) $\sum_{n=1}^3 (3n + 1)$
(e) 1 + 4 + 9 + 16 + ...	(f) $\frac{1}{5}, \frac{3}{8}, \frac{5}{11}, \frac{7}{14}$
3. **Find the value of:**

(a) $\sum_{n=0}^4 (2n - 1)$	(b) $\sum_{n=2}^6 (3n + 2)$	(c) $\sum_{n=1}^5 (n^2 + 1)$
(d) $\sum_{n=1}^3 (n^2 + 2n + 1)$	(e) $\sum_{n=1}^{10} 5n$	(f) $\sum_{n=5}^{10} n^2$
(g) $\sum_{n=3}^8 (n^2 - 2)$	(h) $\sum_{n=1}^5 \left(\frac{2n + 1}{n} \right)$	(i) $\sum_{n=0}^4 \left(\frac{n}{n + 1} \right)$
4. **Write the given series using symbol Σ :**

(a) 5 + 7 + 9 + 11 + ... + 21	(b) 2 + 4 + 6 + 8 + 10 + 12
(c) 30 + 25 + 20 + ... + 5	(d) 1 + 5 + 9 + 13 + 17 + 21
(e) 1 + 4 + 9 + 16	(f) $a + ab^1 + ab^2 + ab^3 + ab^4$

Answers

1 - 2. Show to your teacher.

- | | | | | |
|--------------------------------|------------------------|-------------------------------|----------------------|---------|
| 3. (a) 15 | (b) 70 | (c) 60 | (d) 29 | (e) 275 |
| (f) 355 | (g) 187 | (h) $\frac{737}{60}$ | (i) $\frac{163}{60}$ | |
| 4. (a) $\sum_{n=1}^9 (2n + 3)$ | (b) $\sum_{n=1}^6 2n$ | (c) $\sum_{n=1}^6 (35 - 5n)$ | | |
| (d) $\sum_{n=1}^6 (4n - 3)$ | (e) $\sum_{n=1}^4 n^2$ | (f) $\sum_{n=1}^5 (ab^{n-1})$ | | |

8.3 Arithmetic sequence and series

Study the pattern in the following figures:

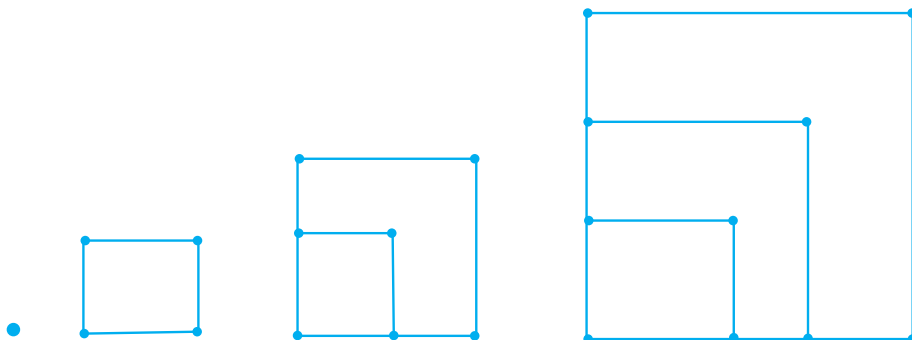

Now, discuss the following questions based on the above figures:

- How can we write the dots in a sequence?
- How does the number of dots increase? Can we find a certain rule?
- How can we find different terms without making a figure(eg. tenth term)?

The dots on the four figures are 1, 4, 7, 10 respectively.

This can be written in the form of sequence as; 1, 4, 7, 10. Each term of the sequence is increased by three. So, the common difference is 3. Eg. $10 - 7 = 3$, $7 - 4 = 3$, $4 - 1 = 3$

Likewise, find the common difference in the sequences 5, 10, 15, 20, 25, and 50, 45, 40, 35, 30.

So, if each term of any sequence is increased or decreased by a fixed number, then its previous terms of the sequence is called an arithmetic sequence. The difference between the successive terms is called the common difference. For example, in the common difference sequences 15, 25, 35, 45, 55 is 10, and the common difference in the sequence 100, 90, 80, 70 is -10.

The common difference in an arithmetic sequence is denoted by d and the first term, second term, third term, ... n^{th} terms are denoted by $t_1, t_2, t_3, \dots, t_n$ respectively.

If, $t_1, t_2, t_3, t_4, \dots, t_{n-1}, t_n$ is an arithmetic sequence,

the common difference (d) = $t_2 - t_1, t_3 - t_2, t_n - t_{n-1}$

The sum of the n terms of the above arithmetic sequence is $S_n = t_1 + t_2 + t_3 + \dots + t_n$

Generally, $d = t_2 - t_1$.

8.3.1 General term of arithmetic sequence

If, $t_1, t_2, t_3, t_4, \dots, t_{n-1}, t_n$ are in arithmetic sequence,

Common difference is $(d) = t_2 - t_1$.

Where, first term $(t_1) = a = a + (1 - 1) \times d$

Second term $(t_2) = a + d = a + (2 - 1) \times d$

Third term $(t_3) = a + 2d = a + (3 - 1) \times d$

$\vdots \quad \quad \quad \vdots \quad \quad \quad \vdots$

n^{th} term $(t_n) = a + (n - 1) \times d$

\therefore General term of arithmetic sequence is $(t_n) = a + (n - 1) d$.

Example 1

The following numbers is the distance travelled by a pedestrian in each step in feet:

3, 6, 9, 12, 15, 18, ...

Find the distance travelled by the pedestrian in the n^{th} step.

Solution,s

Here,

The sequence is 3, 6, 9, 12, 15, 18, This is arithmetic sequence.

where, first term $(t_1) = a = 3$

Common difference $(d) = t_2 - t_1 = 6 - 3 = 3$

Now,

$$\begin{aligned}n^{\text{th}} \text{ term } (t_n) &= a + (n - 1) \times d \\&= 3 + (n - 1) \times 3 \\&= 3 + 3n - 3 \\&= 3n\end{aligned}$$

So, the pedestrain travelled $3n$ feet distance in any n step.

8.4 Geometric sequence and series

First of all, observe the following sequence:

2, 4, 8, 16, 32, 64, ...

2, 6, 18, 54, ...

27, 9, 3, 1, $\frac{1}{3}$, ...

Now, discuss the following questions:

- What is the pattern of the sequences?
- Does the difference between two successive terms equal?
- What is the ratio between two successive terms?
- What is the common rule to find the next term on the basis of its previous term?

In the above sequence, the difference between two successive terms are not equal. Now, find the ratio between two successive terms.

$$\frac{4}{2} = \frac{8}{4} = \frac{16}{8} = \frac{32}{16} = \dots = 2$$

$$\frac{6}{2} = \frac{18}{6} = \frac{54}{18} = \dots = 3$$

Here, the ratio between two successive terms is equal. So, the sequences are called geometric sequences. The series related to the geometric sequence is called geometric series.

$$\text{E.g. } 2 + 4 + 8 + 16 + 32 + 64 + \dots$$

If the n th term of the geometric sequence is (t_n) and the $(n-1)$ term is t_{n-1} , the common difference is $\frac{t_n}{t_{n-1}}$

$t_1 + t_2 + t_3 + \dots + t_n$ is a geometric series. Where t_1, t_2, \dots, t_n are in a geometric sequence.

8.4.1 General term of geometric sequence

If, $t_1 + t_2 + t_3 + \dots + t_{n-1}$, t_n are in geometric sequence,

$$\text{Common ratio } (r) = \frac{t_2}{t_1} = \frac{t_n}{t_{n-1}}$$

$$\text{First term } (t_1) = a$$

$$\text{Second term } (t_2) = ar = ar^{2-1}$$

$$\text{Third term } (t_3) = ar^2 = ar^{3-1}$$

$$\vdots \quad \quad \quad \vdots \quad \quad \quad \vdots$$

$$n^{\text{th}} \text{ term } (t_n) = ar^{n-1}$$

\therefore General term of the geometric sequence is $(t_n) = ar^{n-1}$.

Example 2

A person deposits Rs. 200 in a bank for ten years. He got 10% interest annually and added on the principal. What is total amount after 10 years?

Solution,

The total amount at the end of each year with 10% interest can be written in the following sequence:

[Where principal is Rs. 200]

200, 220, 242, ...

The common ratio is $(r) = \frac{220}{200} = \frac{242}{220} = \frac{11}{10}$

The total amount after ten years is

$$\begin{aligned}t_{10} &= 200 \left(\frac{11}{10}\right)^{10-1} \\&= \text{Rs. } 200(1.1)^9 \\&= \text{Rs. } 200 \times 2.36 \\&= \text{Rs. } 472\end{aligned}$$

Example 3

Write whether the following sequence are arithmetic or geometric with a reason.

(a) 4, 7, 10, 13, ... (b) 3, 6, 12, 24, ...

Solution,

(a) Here,

First term $(t_1) = 4$

Second term $(t_2) = 7$

Third term $(t_3) = 10$

$$\therefore t_2 - t_1 = 7 - 4 = 3$$

$$\text{Again, } t_3 - t_2 = 10 - 7 = 3$$

In this sequence, the difference between two consecutive terms are same. So, it is arithmetic sequence.

(b) Here,

First term $(t_1) = 3$

Second term $(t_2) = 6$

Third term $(t_3) = 12$

$$\therefore \frac{t_2}{t_1} = \frac{6}{3} = 2$$

$$\text{Again, } \frac{t_3}{t_2} = \frac{12}{6} = 2$$

Here, the ratio between two consecutive terms are same. So, it is geometric sequence.

Example 4

Which of the term of the arithmetic sequence 2, 7, 12, ... have value 62?

Solution,

(a) Here,

$$\text{First term } (t_1) = 2$$

$$\text{Second term } (t_2) = 7$$

$$\text{Let } n^{\text{th}} \text{ term } (t_n) = 62$$

$$\text{Number of terms } (n) = ?$$

$$\text{Common difference } (d) = t_2 - t_1 = 7 - 2 = 5$$

We know that,

$$\text{general term } (t_n) = a + (n - 1)d$$

$$\text{or, } 62 = 2 + (n - 1) \times 5$$

$$\text{or, } 62 - 2 = (n - 1) \times 5$$

$$\text{or, } \frac{60}{5} = n - 1$$

$$\text{or, } 12 = n - 1$$

$$\text{or, } n = 12 + 1 = 13$$

\therefore The 13th terms of the arithmetic sequence 2, 7, 12, ... have value 62.

Example 5

If the 2nd term and 5th term of a geometric sequence are 6 and 162 respectively, find 10th term of the sequence.

Solution,

Here,

$$\text{second term } (t_2) = 6$$

$$\text{fifth term } (t_5) = 162$$

$$10^{\text{th}} \text{ term } (t_{10}) = ?$$

We know that,

$$\text{general term } (t_n) = a \cdot r^{n-1}$$

$$\therefore t_2 = ar$$

$$\text{or, } 6 = ar \dots\dots (i)$$

$$t_5 = ar^4$$

$$\text{or, } 162 = ar^4 \dots\dots (ii)$$

Dividing equation (ii) by (i) we get,

$$\frac{ar^4}{ar} = \frac{162}{6}$$

$$\text{or, } r^3 = 27$$

$$\therefore r = 3$$

put $r = 3$, in equation (i),

$$6 = 3a$$

$$\therefore a = 2$$

Now,

$$\begin{aligned} 10^{\text{th}} \text{ term } (t_{10}) &= ar^9 \\ &= 2 \cdot (3)^9 \\ &= 2 \times 19683 \\ &= 39,366 \end{aligned}$$

Exercise 8.3

1. Write which of the following sequence are arithmetic or geometric give reasons.

(a) $4, 2, 1, \frac{1}{2}, \dots$

(b) $4, 10, 16, \dots$

(c) a, ab, ab^2, \dots

(d) $6 + 12 + 24 + \dots$

(c) $30 + 27 + 24 + \dots$

- The third term and ninth term of an arithmetic series are 9 and 33 respectively, find the fifth term of the series.
- Find the 10th term and common difference of the arithmetic sequences 2, 6, 10, 14, 18, ...
- If the fourth term and seventh term of an arithmetic series are 20 and 35 respectively, find its tenth term.
- The first three terms of an arithmetic sequence are $x - 1$, $x + 2$, and $3x$, find the value of x . Also, find the first term and fifth term of the sequence.
- If the fifth term and eighth term of an arithmetic series are 17 and 26 respectively, then which term of the series has a value of 44?
- Find the common ratio and tenth term of the geometric sequence 12, 6, 3, ...
- If the second term and fifth term of a geometric series are 6 and 162 respectively, find its ninth term.
- The first three terms of a geometric sequence are $z + 6$, z , and $z - 3$, find the value of z . Also, find the fifth term of the sequence.

Answers

1. (a) Geometric

(b) Arithmetic

(c) Geometric

(d) Geometric

(e) Arithmetic

2. $t_5 = 17$

3. $d = 4, t_{10} = 38$

4. $t_{10} = 50$

5. $x = \frac{5}{2}, a = \frac{3}{2}, t_5 = \frac{27}{2}$

6. $n = 14$

7. $r = \frac{1}{2}, t_{10} = \frac{3}{128}$

8. 13, 122

9. $z = 6, t_5 = \frac{3}{4}$

Lesson 9

Factorization

9.0 Review

Make different groups in your class. Observe the following pictures carefully and find the area of each figure. Present it in your class.

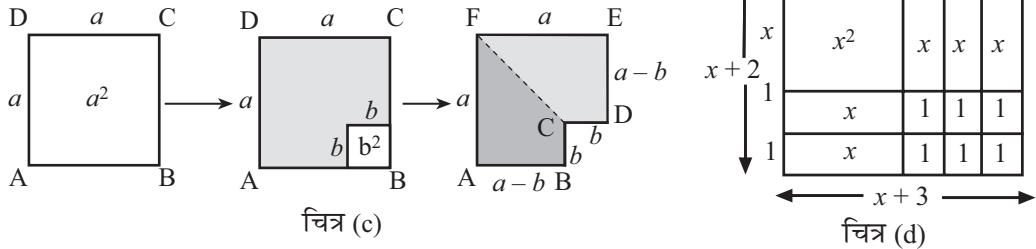
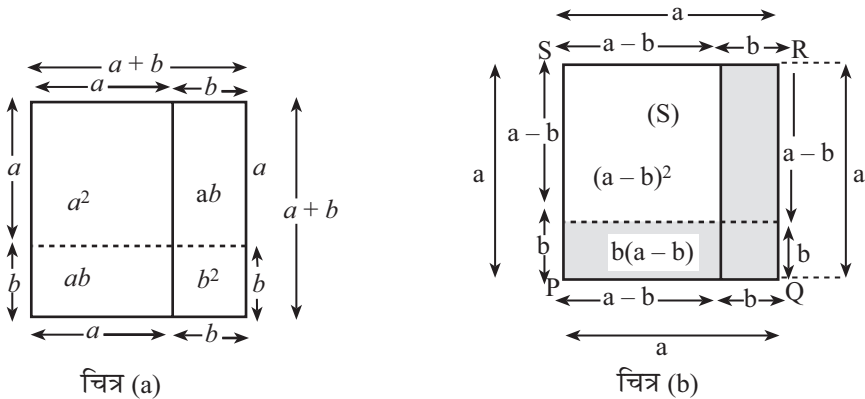

9.1 Factorization of the expression in the form of $(a+b)^3$, (a^3+b^3) , $(a-b)^3$ and (a^3-b^3)

9.1.1 Geometrical concept of $(a+b)^3$

Activity 1

Make different groups of students in your class. Take a soft cubical object in each group eg. a piece of soap. Mark in the ratio of $a:b$ on the object's length, breadth, and height as shown in figure first. Now, cut the object from marked places. Observe the number of pieces and shape of each piece in your group. Present the conclusions in your class.

Find the volume of each piece. Compare the volume of the cube and the sum of the volume of all pieces. Discuss this relationship in your class.

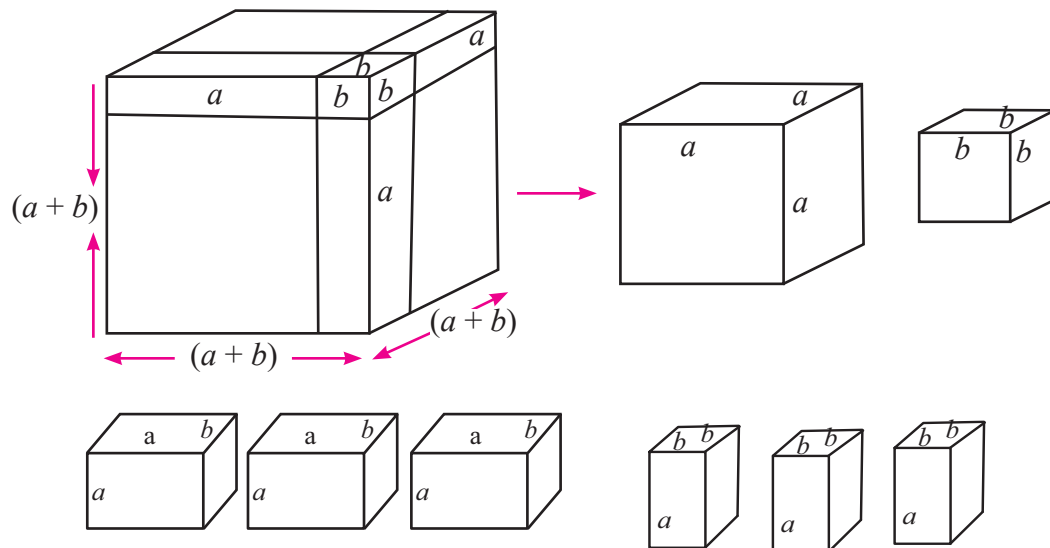

For example, the conclusion of group A is as follows:

The volume of the cube = Volume of some of all pieces.

$$\begin{aligned} \text{Thus, } (a + b)^3 &= a^3 + b^3 + a^2b + a^2b + a^2b + ab^2 + ab^2 + ab^2 \\ &= a^3 + 3a^2b + 3ab^2 + b^3 \\ &= a^3 + 3ab(a + b) + b^3 \end{aligned}$$

- (i) $(a + b)^3 = a^3 + 3a^2b + 3ab^2 + b^3$
- (ii) $(a + b)^3 = a^3 + 3ab(a + b) + b^3$ (Make $3ab$ common from second and third term)
- (iii) $(a + b)^3 = (a + b) \times (a + b) \times (a + b)$

9.1.2 Geometrical concept of $(a - b)^3$

Activity 2

Make different groups of students in your class. Take a soft cubical object each group eg. a piece of soap. Suppose the length of each edge is a unit. Draw a line on $(a-b)$ unit of each edge and cut it into eight different pieces as shown in the following figure. Find the volume of all pieces separately. Compare the volume of the cube and the sum of the volume of all pieces. Discuss this relationship in your class. For example, the conclusion of group B is as follows:

Now, the volume of the cube = Volume of some of all pieces

$$\begin{aligned}
 a^3 &= (a-b)^3 + b^3 + (a-b)^2 \cdot b + (a-b)^2 \cdot b + \\
 &\quad (a-b)^2 b + (a-b)b^2 + (a-b)b^2 + (a-b)b^2 \\
 &= (a-b)^3 + b^3 + 3(a-b)^2 b + 3(a-b)b^2 \\
 &= (a-b)^3 + b^3 + 3b(a^2 - 2ab + b^2) + 3ab^2 - 3b^3 \\
 &= (a-b)^3 + b^3 + 3a^2 b - 6ab^2 + 3b^3 + 3ab^2 - 3b^3 \\
 &= (a-b)^3 + 3a^2 b - 3ab^2 + b^3 \\
 \text{or, } (a-b)^3 &= a^3 - 3a^2 b + 3ab^2 - b^3
 \end{aligned}$$

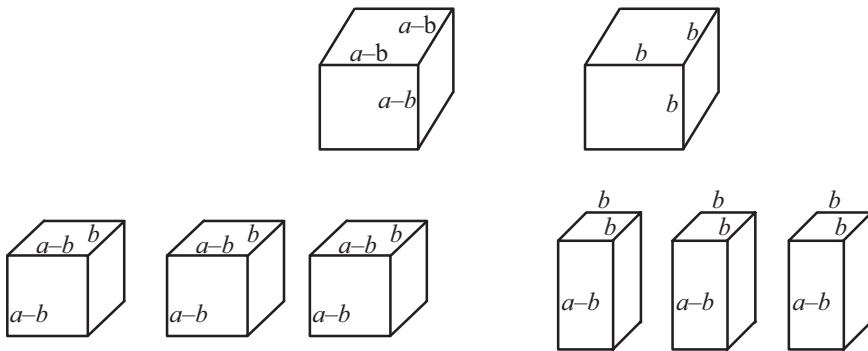
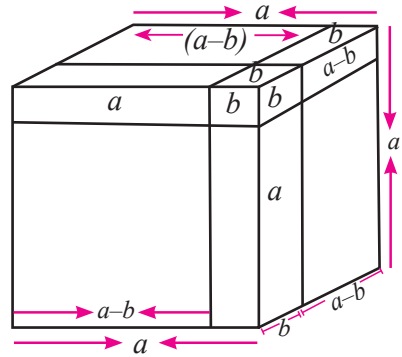

$$= a^3 - 3ab(a-b) - b^3 \quad (\because \text{Take } 3ab \text{ common from second and third terms})$$

- (a) $(a-b)^3 = a^3 - 3ab^2 + 3ab^2 - b^3$
- (b) $(a-b)^3 = a^3 - 3ab(a-b) - b^3$
- (c) $(a-b)^3 = (a-b) \times (a-b) \times (a-b)$

9.1.3 Simplified form of (a^3+b^3)

Activity 3

Make different groups of students in your class. Using the geometrical concept of $(a + b)^3$ and $(a - b)^3$, discuss the simplified form of $(a^3 + b^3)$ in your group.

Here, the conclusion of group C is:

We know that,

$$(a + b)^3 = a^3 + b^3 + 3ab(a + b)$$

or, $(a + b)^3 = 3ab(a + b) + a^3 + b^3$

or, $(a + b)(a + b)^2 - 3ab(a + b) = a^3 + b^3$

or, $(a + b)\{(a + b)^2 - 3ab\} = a^3 + b^3$ [$\because (a + b)$ is common on both]

or, $(a + b)(a^2 + 2ab + b^2 - 3ab) = a^3 + b^3$ [\because using formula of $(a + b)^2$]

or, $(a + b)(a^2 - ab + b^2) = a^3 + b^3$

(i) $a^3 + b^3 = (a + b)^3 - 3ab(a + b)$

(ii) $a^3 + b^3 = (a + b)(a^2 - ab + b^2)$

9.1.4 Simplified form of $(a^3 - b^3)$

We know that,

$$(a - b)^3 = a^3 - b^3 - 3ab(a - b)$$

or, $(a - b)^3 + 3ab(a - b) = a^3 - b^3$

or, $(a - b)(a - b)^2 + 3ab(a - b) = a^3 - b^3$

or, $(a - b)\{(a - b)^2 + 3ab\} = a^3 - b^3$ [\because Taking common $(a - b)$]

or, $(a - b)(a^2 - 2ab + b^2 + 3ab) = a^3 - b^3$

(i) $a^3 - b^3 = (a - b)^3 + 3ab(a - b)$

(ii) $a^3 - b^3 = (a - b)(a^2 + ab + b^2)$

Example 1

Find the cube of $(x + 3)$ using formula:

Solution,

Here,

$$\begin{aligned} & \text{Cube of } (x + 3) \\ &= (x + 3)^3 \\ &= (x)^3 + 3 \cdot x^2 \cdot 3 + 3 \cdot x \cdot 3^2 + 3^3 \\ &= x^3 + 9x^2 + 27x + 27 \end{aligned}$$

$$\boxed{(a + b)^3 = a^3 + 3a^2b + 3ab^2 + b^3}$$

Example 2

Find the cube of $(x - 2)$:

Solution,

Here, cube of $(x - 2)$

$$\begin{aligned} &= (x - 2)^3 \\ &= (x)^3 - 3 \cdot x^2 \cdot 2 + 3 \cdot x \cdot 2^2 - (2)^3 \\ &= x^3 - 6x^2 + 12x - 8 \end{aligned}$$

$$\boxed{(a - b)^3 = a^3 - 3a^2b + 3ab^2 - b^3}$$

Example 3

Factorize:

(a) $(3x + 5y)^3$

(b) $(2x - 7y)^3$

Solution,

Here,

(a) $(3x + 5y)^3 = (3x + 5y)(3x + 5y)(3x + 5y)$

(b) $(2x - 7y)^3 = (2x - 7y)(2x - 7y)(2x - 7y)$

Example 4

Factorize:

(a) $8x^3 + y^3$ (b) $\frac{p^3}{q^3} - \frac{q^3}{p^3}$

Solution,

Here,

$$\begin{aligned} \text{(a)} \quad & 8x^3 + y^3 \\ &= (2x)^3 + (y)^3 \\ &= (2x + y) \{(2x)^2 - 2x \cdot y + (y)^2\} \\ &= (2x + y) (4x^2 - 2xy + y^2) \end{aligned}$$

$$[\because a^3 + b^3 = (a + b)(a^2 - ab + b^2)]$$

$$\begin{aligned}
\text{(b)} \quad \frac{p^3}{q^3} - \frac{q^3}{p^3} &= \left(\frac{p}{q}\right)^3 - \left(\frac{q}{p}\right)^3 \\
&= \left(\frac{p}{q} - \frac{q}{p}\right) \left(\frac{p^2}{q^2} + 1 + \frac{q^2}{p^2}\right) [\because a^3 - b^3 = (a - b)(a^2 + ab + b^2)] \\
&= \left(\frac{p}{q} - \frac{q}{p}\right) \left\{ \left(\frac{p}{q}\right)^2 + \left(\frac{q}{p}\right)^2 + 1 \right\} \\
&= \left(\frac{p}{q} - \frac{q}{p}\right) \left\{ \left(\frac{p}{q} + \frac{q}{p}\right)^2 - 2\frac{p}{q} \cdot \frac{q}{p} + 1 \right\} \\
&= \left(\frac{p}{q} - \frac{q}{p}\right) \left\{ \left(\frac{p}{q} + \frac{q}{p}\right)^2 - 1 \right\} \\
&= \left(\frac{p}{q} - \frac{q}{p}\right) \left\{ \left(\frac{p}{q} + \frac{q}{p}\right)^2 - (1)^2 \right\} \\
&= \left(\frac{p}{q} - \frac{q}{p}\right) \left(\frac{p}{q} + 1 + \frac{q}{p}\right) \left(\frac{p}{q} - 1 + \frac{q}{p}\right)
\end{aligned}$$

Exercise 9.1

1. Find the cube of following expressions using formula:

- | | |
|-----------------|------------------------------------|
| (a) $(x + 1)$ | (b) $(x - 3)$ |
| (c) $(x + 4)$ | (d) $(2x - 1)$ |
| (e) $(3y + 2b)$ | (f) $\left[\frac{x}{2} - 1\right]$ |

2. Write the following expressions in the expanded form:

- | | |
|-------------------|-------------------|
| (a) $(2x + 3y)^3$ | (b) $(5a - 8b)^3$ |
|-------------------|-------------------|

3. Write the given expressions in the form of $(a + b)^3$:

- | |
|---|
| (a) $27a^3 + 108a^2b + 144ab^2 + 64b^3$ |
| (b) $8x^3 + 36x^2y + 54xy^2 + 27y^3$ |

4. Write the following expressions in the form of $(a - b)^3$:

- | |
|--|
| (a) $64m^3 - 48m^2n + 12mn^2 - n^3$ |
| (b) $125p^3 - 150p^2q + 60pq^2 - 8q^3$ |

5. Factorize the following:

(a) $8x^4 + 27x$ (b) $x^3 + 8y^3$ (c) $1 + 125x^3$

(d) $8x^3 + \frac{1}{x^3}$ (e) $(a + b)^3 + 1$ (f) $x^6 + y^6$

6. Factorize the following expressions:

(a) $250m^4 - 2m$ (b) $x^3y - 64y^4$ (c) $64p^6q^3 - 125$

(d) $(a - b)^3 - 8(a + b)^3$ (e) $\frac{x^3}{y^3} - \frac{y^3}{x^3}$ (f) $p^3 - \frac{1}{p^3}$

7. How many cubic feet wood is remain if we cut a pieces of cubical wood having length 7 ft from a cubical log of x feet length? ($x > 7$ ft)

Answer

1. (a) $x^3 + 3x^2 + 3x + 1$ (b) $x^3 - 9x^2 + 27x - 27$ (c) $x^3 + 12x^2 + 48x + 64$

(d) $8x^3 - 12x^2 + 6x - 1$ (e) $27y^3 + 54y^2b + 36yb^2 + 8b^3$

(f) $\frac{1}{8}x^3 - \frac{3}{4}x^2 + \frac{3}{2}x - 1$

2. (a) $(2x + 3y)(2x + 3y)(2x + 3y)$ (b) $(5a - 8b)(5a - 8b)(5a - 8b)$

(c) $(10p - 6q)(10p - 6q)(10p - 6q)$ (d) $(12m - 5n)(12m - 5n)(12m - 5n)$

3. (e) $(3a + 4b)^3$ (f) $(2x + 3y)^3$

4. (a) $(4m - n)^3$ (b) $(5p - 2q)^3$

5. (a) $x(2x + 3)(4x^2 - 6x + 9)$ (b) $(x + 2y)(x^2 - 2xy + 4y^2)$

(c) $(1 + 5x)(1 - 5x + 25x^2)$ (d) $\left(2x + \frac{1}{x}\right)\left(4x^2 - 2 + \frac{1}{x^2}\right)$

(e) $(a + b + 1)(a^2 + 2ab + b^2 - a - b + 1)$

(f) $(x^2 + y^2)(x^4 - x^2y^2 + y^4)$

6. (a) $2m(5m - 1)(25m^2 + 5m + 1)$

(b) $y(x - 4y)(x^2 + 4xy + 16y^2)$

(c) $(4p^2q - 5)(16p^4q^2 + 20p^2q + 125)$

(d) $-(a + 3b)(7a^2 + 6ab + 3b^2)$

(e) $\left(\frac{x}{y} - \frac{y}{x}\right)\left(\frac{y^2}{x^2} + 1 + \frac{y^2}{x^2}\right)$ (f) $\left(p - \frac{1}{p}\right)\left(p^2 + 1 + \frac{1}{p^2}\right)$

7. $(x^3 - 343) \text{ ft}^3$

9.2 Factorization of the expression in the form of $a^4 + a^2b^2 + b^4$

Activity 1

Discuss how we can factorize the expression, $a^4 + a^2b^2 + b^4$ with your friend.

Here,

$$\begin{aligned} &= (a^2)^2 + 2a^2b^2 - a^2b^2 + (b^2)^2 \\ &= (a^2 + b^2)^2 - (ab)^2 && [\because (a + b)^2 = a^2 + 2ab + b^2] \\ &= (a^2 + b^2 + ab)(a^2 + b^2 - ab) && [\because a^2 - b^2 = (a + b)(a - b)] \\ &= (a^2 + ab + b^2)(a^2 - ab + b^2) \end{aligned}$$

$$a^4 + a^2b^2 + b^4 = (a^2 + ab + b^2)(a^2 - ab + b^2)$$

Activity 2

Can we factorize the expression $a^4 + a^2b^2 + b^4$ other than the method used to factorize in above Activity 1? Discuss in your group.

The method of factorization presented by a group is:

$$\begin{aligned} &a^4 + a^2b^2 + b^4 \\ &= (a^2)^2 + (b^2)^2 + a^2b^2 \\ &= (a^2 + b^2)^2 - 2a^2b^2 + a^2b^2 && [\because a^2 + b^2 = (a + b)^2 - 2ab] \\ &= (a^2 + b^2)^2 - a^2b^2 \\ &= (a^2 + b^2)^2 - (ab)^2 \\ &= (a^2 + b^2 + ab)(a^2 + b^2 - ab) && [\because a^2 - b^2 = (a + b)(a - b)] \\ &= (a^2 + ab + b^2)(a^2 - ab + b^2) \end{aligned}$$

In above example, the terms having power 4 are collected together and use the formula $(a + b)^2 - 2ab$ to factorize given expression.

Example 1

Factorize: $y^4 + y^2 + 1$

Solution,

$$\begin{aligned}\text{Here, } y^4 + y^2 + 1 &= (y^2)^2 + (1)^2 + y^2 \\ &= (y^2 + 1)^2 - 2y^2 \cdot 1 + y^2 && [\because a^2 + b^2 = (a + b)^2 - 2ab] \\ &= (y^2 + 1)^2 - (y)^2 \\ &= (y^2 + 1 + y)(y^2 + 1 - y) && [\because a^2 - b^2 = (a + b)(a - b)] \\ &= (y^2 + y + 1)(y^2 - y + 1)\end{aligned}$$

Example 2

Factorize: $y^4 + 64$

Solution,

$$\begin{aligned}\text{Here, } y^4 + 64 &= (y^2)^2 + (8)^2 \\ &= (y^2 + 8)^2 - 2 \cdot y^2 \cdot 8 \\ &= (y^2 + 8)^2 - 16y^2 \\ &= (y^2 + 8)^2 - (4y)^2 \\ &= (y^2 + 8 + 4y)(y^2 + 8 - 4y) \\ &= (y^2 + 4y + 8)(y^2 - 4y + 8)\end{aligned}$$

Example 3

Factorize: $49a^4 - 154a^2b^2 + 9b^4$

Solution,

$$\begin{aligned}\text{Here, } 49a^4 - 154a^2b^2 + 9b^4 &= (7a^2)^2 + (3b^2)^2 - 154a^2b^2 \\ &= (7a^2 + 3b^2)^2 - 2 \cdot 7a^2 \cdot 3b^2 - 154a^2b^2 \\ &= (7a^2 + 3b^2)^2 - 42a^2b^2 - 154a^2b^2 \\ &= (7a^2 + 3b^2)^2 - 196a^2b^2 \\ &= (7a^2 + 3b^2)^2 - (14ab)^2 \\ &= (7a^2 + 3b^2 + 14ab)(7a^2 + 3b^2 - 14ab) \\ &= (7a^2 + 14ab + 3b^2)(7a^2 - 14ab + 3b^2)\end{aligned}$$

Example 4

Factorize: $p^4 - 3p^2 + 1$

Solution,

Here, $p^4 - 3p^2 + 1$

$$\begin{aligned} &= (p^2)^2 + (1)^2 - 3p^2 \\ &= (p^2 - 1)^2 + 2 \cdot p^2 \cdot 1 - 3p^2 \quad [\because a^2 + b^2 = (a - b)^2 + 2ab] \\ &= (p^2 - 1)^2 - p^2 \\ &= (p^2 - 1)^2 - (p)^2 \\ &= (p^2 - 1 + p)(p^2 - 1 - p) \\ &= (p^2 + p - 1)(p^2 - p - 1) \end{aligned}$$

Example 5

Factorize: $\frac{x^4}{y^4} + \frac{x^2}{y^2} + 1$

Solution,

Here,

$$\begin{aligned} &\frac{x^4}{y^4} + \frac{x^2}{y^2} + 1 \\ &= \left(\frac{x^2}{y^2}\right)^2 + (1)^2 + \frac{x^2}{y^2} \\ &= \left(\frac{x^2}{y^2} + 1\right)^2 - 2 \cdot \frac{x^2}{y^2} \cdot 1 + \frac{x^2}{y^2} \\ &= \left(\frac{x^2}{y^2} + 1\right)^2 - \frac{x^2}{y^2} \\ &= \left(\frac{x^2}{y^2} + 1\right)^2 - \left(\frac{x}{y}\right)^2 \\ &= \left(\frac{x^2}{y^2} + 1 + \frac{x}{y}\right)\left(\frac{x^2}{y^2} + 1 - \frac{x}{y}\right) \\ &= \left(\frac{x^2}{y^2} + \frac{x}{y} + 1\right)\left(\frac{x^2}{y^2} - \frac{x}{y} + 1\right) \end{aligned}$$

Example 6

Factorize: $x^2 - 10x + 24 + 6y - 9y^2$

Solution,

Here,

$$\begin{aligned} & x^2 - 10x + 24 + 6y - 9y^2 \\ &= (x)^2 - 2 \cdot x \cdot 5 + (5)^2 - (5)^2 + 24 + 6y - 9y^2 \\ &= (x - 5)^2 - 25 + 24 + 6y - 9y^2 \\ &= (x - 5)^2 - 1 + 6y - 9y^2 \\ &= (x - 5)^2 - (1 - 6y + 9y^2) \\ &= (x - 5)^2 - \{(1)^2 - 2 \cdot 1 \cdot 3y + (3y)^2\} \\ &= (x - 5)^2 - (1 - 3y)^2 \\ &= (x - 5 + 1 - 3y)(x - 5 - 1 + 3y) \\ &= (x - 3y - 4)(x + 3y - 6) \end{aligned}$$

Exercise 9.2

1. Factorize:

- | | |
|----------------------------------|---------------------------------|
| (a) $x^4 + x^2y^2 + y^4$ | (b) $16x^4 + 7x^2 + 1$ |
| (c) $16x^4 + 36x^2y^2 + 81y^4$ | (d) $4m^4 + 35m^2n^2 + 121n^4$ |
| (e) $48a^4 + 108a^2b^2 + 243b^4$ | (f) $32p^4 + 72p^2q^2 + 162q^4$ |

2. Factorize:

- | | |
|---------------------|--------------------|
| (a) $x^4 + 4$ | (b) $4x^4 + 81y^4$ |
| (c) $64e^4 + f^4$ | (d) $m^4 + 4n^4$ |
| (e) $81x^4 + 64y^4$ | (f) $y^4 + 324x^4$ |

3. Factorize following algebraic expressions:

- | | |
|--------------------------------|---------------------------------|
| (a) $x^4 - 5x^2y^2 + 4y^4$ | (b) $x^4 - 22x^2y^2 + 9y^4$ |
| (c) $b^4 - 3b^2 + 1$ | (d) $25x^4 - 34x^2y^2 + 9y^4$ |
| (e) $49a^4 - 154a^2b^2 + 9b^4$ | (f) $25a^5b - 9a^3b^3 + 16ab^5$ |

4. Factorize following expressions:

- (a) $\frac{m^4}{n^4} + 1 + \frac{n^4}{m^4}$ (b) $y^4 + \frac{1}{y^4} + 1$
(c) $\frac{a^4}{b^4} - \frac{5a^2}{b^2} + 4$ (d) $\frac{p^4}{q^4} + 1 + \frac{p^2}{q^2}$
(e) $\frac{a^4}{b^4} + 1 - \frac{7a^2}{b^2}$ (f) $x^4 + \frac{1}{x^4} - 7$

5. Factorize:

- (a) $p^2 - 10p + 24 + 6q - 9q^2$ (b) $p^4 - 8p^2 - 33 - 14q - q^2$
(c) $a^2 - 12a - 28 + 16b - b^2$ (d) $x^4 + 9 - 7x^2 + 2xy - y^2$
(e) $25x^2 - 49y^2 + 30x + 70y - 16$ (f) $49x^2 + 16y^2 - 64z^2 + 56xy + 16z - 1$
6. Factorize the expression $x^{10} - 10x^6 + 9x^2$ and find its factors.

Answers

1. (a) $-x^2 + xy + y^2$ ($x^2 - xy + y^2$) (b) $(4x^2 + x + 1)(4x^2 - x + 1)$
(c) $-4x^2 + 6xy + 9y^2$ ($4x^2 - 6xy + 9y^2$)
(d) $-2m^2 + 3mn + 11n^2$ ($2m^2 - 3mn + 11n^2$)
(e) $3(4a^2 + 6ab + 9b^2)$ ($4a^2 - 6ab + 9b^2$)
(f) $2(4p^2 + 6pq + 9q^2)$ ($4p^2 - 6pq + 9q^2$)
2. (a) $(x^2 + 2x + 2)(x^2 - 2x + 2)$ (b) $(2x^2 + 6xy + 9y^2)(2x^2 - 6xy + 9y^2)$
(c) $(8e^2 + 4ef + f^2)(8e^2 - 4ef + f^2)$ (d) $(m^2 + 2mn + 2n^2)(m^2 - 2mn + 2n^2)$
(e) $(9x^2 + 12xy + 8y^2)(9x^2 - 12xy + 8y^2)$
(f) $(y^2 + 6xy + 18x^2)(y^2 - 6xy + 18x^2)$
3. (a) $(x^2 + 3xy + 2y^2)(x^2 - 3xy + 2y^2)$
(b) $(x^2 + 4xy - 3y^2)(x^2 - 4xy - 3y^2)$ (c) $(b^2 + b - 1)(-b^2 - b - 1)$
(d) $(5x^2 + 2xy - 3y^2)(5x^2 - 2xy - 3y^2)$
 OR $(5x^2 + 8xy + 3y^2)(5x^2 - 8xy + 3y^2)$
(e) $(7a^2 + 14ab + 3b^2)(7a^2 - 14ab + 3b^2)$
(f) $ab(5a^2 + 7ab + 4b^2)(5a^2 - 7ab + 4b^2)$

4. (a) $\left(\frac{m^2}{n^2} + 1 + \frac{n^2}{m^2}\right)\left(\frac{m^2}{n^2} - 1 + \frac{n^2}{m^2}\right)$ (b) $\left(y^2 + 1 + \frac{1}{y^2}\right)\left(y^2 - 1 + \frac{1}{y^2}\right)$

(c) $\left(\frac{a^2}{b^2} + \frac{3a}{b} + 2\right)\left(\frac{a^2}{b^2} - \frac{3a}{b} + 2\right)$ (d) $\left(\frac{p^2}{q^2} + \frac{p}{q} + 1\right)\left(\frac{p^2}{q^2} - \frac{p}{q} + 1\right)$

(e) $\left(\frac{a^2}{b^2} + \frac{3a}{b} + 1\right)\left(\frac{a^2}{b^2} - \frac{3a}{b} + 1\right)$ (f) $\left(x^2 + 3 + \frac{1}{x^2}\right)\left(x^2 - 3 + \frac{1}{x^2}\right)$

5. (a) $(p + 3q - 6)(p - 3q - 4)$

(b) $[(p^2 + q + 3) - p^2 - q - 11]$

(c) $(a + b - 14)(a - b + 2)$

(d) $(x^2 + x - y - 3) - (x^2 - x + y - 3)$

(e) $-5x - 7y + 8) - 5x + 7y - 2)$

(f) $(7x^2 + 4y + 8z - 1)(7x^2 + 4y - 8z + 1)$

6. $x^2(x^2 + 3)(x^2 + 1)(x^2 - 3)(x + 1)(x - 1)$

Lesson 10

Highest Common Factor and Lowest Common Multiple

10.0 Review

Discuss with your nearest friends in your class and find the HCF and LCM of given algebraic expressions. Also, present it to your class:

$$2x^2 - 8y^2 \text{ and } 2x^4 + 16xy^3$$

Here, to find the HCF and LCM of given expressions we have to factorize the given expressions as;

$$\begin{aligned}\text{First Expression} &= 2x^2 - 8y^2 \\ &= 2(x^2 - 4y^2) \\ &= 2\{x^2 - (2y)^2\} \\ &= 2(x - 2y)(x + 2y)\end{aligned}$$

$$\begin{aligned}\text{Second Expression} &= 2x(x^3 + 8y^3) \\ &= 2x\{(x)^3 + (2y)^3\} \\ &= 2x(x + 2y)(x^2 - 2xy + 4y^2)\end{aligned}$$

$$\text{Now, HCF} = \text{Common Factor} = 2 \times (x + 2y) = 2(x + 2y)$$

$$\begin{aligned}\text{LCM} &= \text{common factors} \times \text{remaining factors} \\ &= 2 \times (x + 2y) \times (x - 2y) \times x \times (x^2 - 2xy + 4y^2) \\ &= 2x(x - 2y)(x^3 + 8y^3)\end{aligned}$$

10.1 Highest Common Factor

Activity 1

Take the algebraic expressions $x^2 - 4$ and $x^3 - 8$, discuss the following questions and conclude;

- What are the factors of the given expressions?
- What are the common factors on them?
- What are these common factors called?
- Present these factors in a Venn diagram.

Here, factors of the first expression $x^2 - 4$ are $(x + 2)$ and $(x - 2)$.

We should apply the following process in the factorization method:

- Taking common
- Express the given algebraic expressions in the form of a formula
- Factorize it

Factors of the second expression $x^3 - 8$ are $(x - 2)$ and $(x^2 + 2x + 4)$.

The common factor is the factor included in both expressions. So, the common factor is $(x - 2)$.

This common factor is the Highest Common Factor(HCF) in the given expressions.

Hence, HCF is $(x - 2)$

The product of common factors of given expression is called Highest Common Factor (HCF).

Example 1

Find HCF of $x^2 - 9$ and $x^3 + 27$ and present it in venn diagram:

Solution,

Here,

$$\begin{aligned}\text{First expression} &= (x^2 - 9) \\ &= (x + 3)(x - 3)\end{aligned}$$

$$\begin{aligned}\text{Second expression} &= x^3 + 27 \\ &= (x)^3 + (3)^3 \\ &= (x + 3)(x^2 - 3x + 9)\end{aligned}$$

$$\therefore \text{HCF} = \text{common factors} = (x + 3)$$

Example 2

Find HCF of following expressions:

- (a) $8x^3 + y^3$ and $16x^4 + 4x^2y^2 + y^4$
- (b) $p^3 - q^3$ and $p^3 + q^3$
- (c) $x^3y + y^4$, $x^4 + x^2y^2 + y^4$, $2x^3 - 2x^2y + 2xy^2$
- (d) $16a^4 - 4a^2 - 4a - 1$, $16a^4 + 16a^3 + 4a^2 - 1$, $16a^4 + 4a^2 + 1$

Solution,

Here,

(a) **First expression** $= 8x^3 + y^3$
 $= (2x)^3 + (y)^3$
 $= (2x + y)(4x^2 - 2xy + y^2)$

Second expression $= 16x^4 + 4x^2y^2 + y^4$
 $= (4x^2)^2 + (y^2)^2 + 4x^2y^2$
 $= (4x^2 + y^2)^2 - 2 \cdot 4x^2 \cdot y^2 + 4x^2y^2$ $[\because a^2 + b^2 = (a + b)^2 - 2ab]$
 $= (4x^2 + y^2)^2 - 4x^2y^2$
 $= (4x^2 + y^2)^2 - (2xy)^2$
 $= (4x^2 + y^2 + 2xy)(4x^2 + y^2 - 2xy)$ $[\because a^2 - b^2 = (a + b)(a - b)]$
 $= (4x^2 + 2xy + y^2)(4x^2 - 2xy + y^2)$

So, HCF $= (4x^2 - 2xy + y^2)$

(b) **First expression** $= p^3 - q^3$
 $= (p - q)(p^2 + pq + q^2)$

Second expression $= p^3 + q^3$
 $= (p + q)(p^2 - pq + q^2)$

Now, HCF = 1

Note: If the given expressions have no common factors, then HCF = 1.

(c) Here, first expression $= x^3y + y^4$
 $= y(x^3 + y^3)$
 $= y(x + y)(x^2 - xy + y^2)$

Second expression $= x^4 + x^2y^2 + y^4$

$$\begin{aligned}
&= (x^2)^2 + (y^2)^2 + x^2y^2 \\
&= (x^2 + y^2)^2 - 2x^2y^2 + x^2y^2 && [\because a^2 + b^2 = (a + b)^2 - 2ab] \\
&= (x^2 + y^2)^2 - x^2y^2 \\
&= (x^2 + y^2)^2 - (xy)^2 \\
&= (x^2 + y^2 + xy)(x^2 + y^2 - xy) && [\because a^2 - b^2 = (a + b)(a - b)] \\
&= (x^2 + xy + y^2)(x^2 - xy + y^2)
\end{aligned}$$

$$\begin{aligned}
\text{Third expression} &= 2x^3 - 2x^2y + 2xy^2 \\
&= 2x(x^2 - xy + y^2)
\end{aligned}$$

$$\text{So, HCF} = (x^2 - xy + y^2)$$

(d) Here, first expression = $16a^4 - 4a^2 - 4a - 1$

$$\begin{aligned}
&= 16a^4 - (4a^2 + 4a + 1) \\
&= 16a^4 - \{(2a)^2 + 2 \cdot 2a \cdot 1 + (1)^2\} \\
&= (4a^2)^2 - (2a + 1)^2 \\
&= (4a^2 + 2a + 1)(4a^2 - 2a - 1)
\end{aligned}$$

$$\begin{aligned}
\text{Second expression} &= 16a^4 + 16a^3 + 4a^2 - 1 \\
&= (4a^2)^2 + 2 \cdot 4a^2 \cdot 2a + (2a)^2 - 1 \\
&= (4a^2 + 2a)^2 - (1)^2 \\
&= (4a^2 + 2a + 1)(4a^2 + 2a - 1)
\end{aligned}$$

$$\begin{aligned}
\text{Third expression} &= 16a^4 + 4a^2 + 1 \\
&= (4a^2)^2 + (1)^2 + 4a^2 \\
&= (4a^2 + 1)^2 - 2 \cdot 4a^2 \cdot 1 + 4a^2 \\
&= (4a^2 + 1)^2 - 4a^2 \\
&= (4a^2 + 1)^2 - (2a)^2 \\
&= (4a^2 + 1 + 2a)(4a^2 + 1 - 2a) \\
&= (4a^2 + 2a + 1)(4a^2 - 2a + 1)
\end{aligned}$$

$$\text{So, HCF} = 4a^2 + 2a + 1$$

Example 3

Find HCF of the following expressions:

(a) $5m^3 - 20m$, $m^3 - 3m^2 - 10m$, $m^3 - m^2 - 2m + 8$

(b) $(a - b)^2 + 4ab$, $(a + b)^3 - 3ab(a + b)$, $a^2 + (2a + b)b$

Solution,

Here,

(a) First expression $= 5m^3 - 20m$
 $= 5m(m^2 - 4)$
 $= 5m\{(m)^2 - (2)^2\}$
 $= 5m(m + 2)(m - 2)$

Second expression $= m^3 - 3m^2 - 10m$
 $= m(m^2 - 3m - 10)$
 $= m\{m^2 - (5 - 2)m - 10\}$
 $= m(m^2 - 5m + 2m - 10)$
 $= m\{m(m - 5) + 2(m - 5)\}$
 $= m(m - 5)(m + 2)$

Third expression $= m^3 - m^2 - 2m + 8$
 $= m^3 + 8 - m^2 - 2m$
 $= (m)^3 + (2)^3 - m(m + 2)$
 $= (m + 2)(m^2 - 2m + 4) - m(m + 2)$
 $= (m + 2)(m^2 - 2m + 4 - m)$
 $= (m + 2)(m^2 - 3m + 4)$

So, HCF = $(m + 2)$

(b) Here,

$$\begin{aligned}\text{First expression} &= (a - b)^2 + 4ab \\ &= a^2 - 2ab + b^2 + 4ab \\ &= a^2 + 2ab + b^2 \\ &= (a + b)^2 \\ &= (a + b)(a + b)\end{aligned}$$

$$\begin{aligned}\text{Second expression} &= (a + b)^3 - 3ab(a + b) \\ &= (a + b)\{(a + b)^2 - 3ab\} \\ &= (a + b)(a^2 + 2ab + b^2 - 3ab) \\ &= (a + b)(a^2 - ab + b^2)\end{aligned}$$

$$\begin{aligned}\text{Third expression} &= a^2 + (2a + b)b \\ &= a^2 + 2ab + b^2 \\ &= (a + b)^2 \\ &= (a + b)(a + b)\end{aligned}$$

So, HCF = $(a + b)$

Exercise 10.1

- What do you mean by HCF of algebraic expression?
 - In what condition the HCF of algebraic expression becomes 1?
 - What is the common factors of the expression $4x^3y$ and $3z^{37}$?
- Find the Highest Common Factor (HCF) of following expressions:**
 - $(x + y)^2$ and $(x + y)(x - y)$
 - $(x - y)(x^2 + xy + y^2)$ and $(x^2 + xy + y^2)(x^2 - xy + y^2)$
 - $(2x - 3y)(4x^2 + 6xy + 9y^2)$ and $4xy(2x - 3y)(2x + 3y)$
 - $4a^3b(a - b)(a + b - 1)$ and $16a^2b^2(a + 2b)(a + b - 1)$
- Find the HCF of following algebraic expressions:**
 - $a^2 - ab$ and $a^3b - a^2b^2$
 - $3x^2 + 9x$ and $7x + 21$
 - $a^3 + 1$ and $a^4 + a^2 + 1$
 - $8x^3 + 27y^3$ and $16x^4 + 36x^2y^2 + 81y^4$
 - $m^3 + 1 + 2m^2 + 2m$ and $m^3 - 1$
 - $8(6x^4 - x^3 - 2x^2)$ and $12(2x^6 + 3x^5 + x^4)$
 - $a^2 + 4ab + 4b^2 - c^2$ and $a^2 - 4b^2 + ac - 2bc$
 - $x^4 + 4y^4$ and $2x^3y + 4xy^3 + 4x^2y^2$
 - $x^2 - 10x + 24 + 6y - 9y^2$ and $x^2 + 3xy - 6x$
 - $(1 - x^2)(1 - y^2) + 4xy$ and $1 - 2x + y - x^2y + x^2$
 - $8a^3 + 1$ and $16a^4 - 4a^2 + 4a - 1$
 - $2a^3 - a^2 + a - 2$ and $a^3 - a^2 + a - 1$
- Find the HCF of given expressions:**
 - $a^3 + b^3$, $a^3 - a^2b + ab^2$ and $a^4 + a^2b^2 + b^4$
 - $x^3 + 2x^2 + 2x + 1$, $x^3 - 1$ and $x^4 + x^2 + 1$
 - $x^3 - 4x$, $4x^3 - 10x^2 + 4x$ and $3x^4 - 8x^3 + 4x^2$
 - $y^2 + 2y - 8$, $y^2 - 5y + 6$ and $y^2 + 5y - 14$
 - $x^2 + 2x + 1$, $x^2 + 5x + 6$ and $2x^2 - 5x + 2$
 - $x^2 + 2x - 8$, $x^2 - 2x - 24$ and $x^2 + 5x + 4$

- (g) $x^3 + 2x^2 + 4x$, $x^4 + 4x^2 + 16$ and $x^3 - 8$
- (h) $8x^3 + 27y^3$, $16x^4 + 36x^2y^2 + 81y^4$ and $4x^3 - 6x^2y + 9xy^2$
- (i) $2x^3 - 54$, $24x^4 + 18x^2 + 162$ and $2x^2 + 6x + 18$
- (j) $9x^2 - 3y^2 - 8yz - 4z^2$, $4z^2 - 4y^2 - 9x^2 - 12xy$ and $9x^2 + 12xz + 4z^2 - 4y^2$
- (k) $2ax^2 + 2ax - 12a$, $3a^2x^2 - 7a^2x - 6a^2$ and $a^3x^2 + 4a^3x - 21a^3$
- (l) $x^3 + 64y^3$, $x^4 + 16x^2y^2 + 256y^4$ and $4x^3 - 16x^2y + 64y^2x$
- (m) $(a + b)^3 - 3ab(a + b)$, $a^4 + a^2b^2 + b^4$ and $a^4 - 2a^3b + a^2b^2 - b^4$
5. The area of three different rooms are $(x + 3)(x + 6)$, $(x^2 + 8x + 15)$ and $(x^2 + 7x + 12)$ square unit respectively. Find the breadth of the rooms.

Answers

2. (a) $x + y$ (b) $(x^2 + xy + y^2)$
 (c) $(2x - 3y)(2x + 3y)$ (d) $4a^2b(a + b - 1)$
3. (a) $a(a - b)$ (b) $(x + 3)$
 (c) $(a^2 - a + 1)$ (d) $(4x^2 - 6xy + 9y^2)$
 (e) $(m^2 + m + 1)$ (f) $4x^2(2x + 1)$
 (g) $(a + 2ab + c)$ (h) $(x^2 + 2xy + 2y^2)$
 (i) $(x + 3y - 6)$ (j) $(1 - x + y + xy)$
 (k) $(4a^2 - 2a + 1)$ (l) $a - 1$
4. (a) $(a^2 - ab + b^2)$ (b) $x^2 + x + 1$
 (c) $x(x - 2)$ (d) $(y - 2)$
 (e) 1 (f) $(x + 4)$
 (g) $(x^2 + 2x + 4)$ (h) $(4x^2 + 6xy + 9y^2)$
 (i) 2 (j) $(3x + 2y + 2z)$
 (k) $a(x - 3)$ (l) $(x^2 - 4xy + 16y^2)$
 (m) $a^2 - ab + b^2$
5. $(x + 3)$ unit

10.2 Lowest common multiple

Activity 1

Take two expressions $x^3 - 125y^3$ and $x^4 - 15x^2y^2 + 25y^4$ by each student. Factorize these statements. Observe the factors of each expression and find the answer to the following questions in your group:

- Write the common factors of given expressions.
- Find the factors other than the common factors.
- What is the product of common factors and remaining factors called?
- Analyze the result between the product of the factors of given algebraic expressions and the product of their HCF and LCM.

To find the common factors of the given expressions, we have to factorize them as:

$$\begin{aligned}\text{First expressions} &= x^3 - 125y^3 \\ &= (x)^3 - (5y)^3 \\ &= (x - 5y)(x^2 + 5xy + 25y^2)\end{aligned}$$

$$\begin{aligned}\text{Similarly, second expressions} &= x^4 + 25x^2y^2 + 625y^4 \\ &= (x^2)^2 + (25y^2)^2 + 25x^2y^2 \\ &= (x^2 + 25y^2)^2 - 2 \cdot x^2 \cdot 25y^2 + 25x^2y^2 \\ &= (x^2 + 25y^2)^2 - 25x^2y^2 \\ &= (x^2 + 25y^2)^2 - (5xy)^2 \\ &= (x^2 + 25y^2 + 5xy)(x^2 + 25y^2 - 5xy) \\ &= (x^2 + 5xy + 25y^2)(x^2 - 5xy + 25y^2)\end{aligned}$$

Observing the factors of two algebraic expression, we found,

$$\text{Common factors} = x^2 + 5xy + 25y^2$$

By second question, remaining factors $(x - 5y)$ and $(x^2 - 5xy + 25y^2)$.

By third question, the product of common factors and remaining factors is:

$$\begin{aligned}&= (x^2 + 5xy + 25y^2) \times (x - 5y) \times (x^2 - 5xy + 25y^2) \\ &= (x - 5y)(x^2 + 5xy + 25y^2)(x^2 - 5xy + 25y^2) \\ &= (x^3 - 125y^3)(x^2 - 5xy + 25y^2)\end{aligned}$$

The product of common factors and remaining factors is the LCM of given expressions.

The product of common factors and remaining factors of given algebraic expression is called Lowest Common Multiple. In short, it is written as LCM.

Activity 2

Take three algebraic expressions $(x - y)^2 + 4xy$, $(x + y)^3 - 3xy(x + y)$ and $x^2 + 2xy + y^2$. Find the LCM of the given expressions and present the result in your class. The work of one group is as follows:

$$\begin{aligned}\text{First expression} &= (x - y)^2 + 4xy \\ &= x^2 - 2xy + y^2 + 4xy \\ &= x^2 + 2xy + y^2 \\ &= (x + y)^2 = (x + y)(x + y)\end{aligned}$$

$$\begin{aligned}\text{Second expression} &= (x + y)^3 - 3xy(x + y) \\ &= (x + y) \{(x + y)^2 - 3xy\} \\ &= (x + y)(x^2 + 2xy + y^2 - 3xy) \\ &= (x + y)(x^2 - xy + y^2)\end{aligned}$$

$$\begin{aligned}\text{Third expression} &= x^2 + 2xy + y^2 \\ &= (x + y)^2 \\ &= (x + y)(x + y)\end{aligned}$$

$$\text{Common factors} = (x + y)(x + y)$$

$$\text{Remaining factors} = (x^2 - xy + y^2)$$

$$\text{LCM} = \text{common factors} \times \text{remaining factors} = (x + y)(x + y)(x^2 - xy + y^2)$$

To find the HCF of three expressions, the factors common to the two expressions are also common factors.

Example 1

Find the LCM of following expressions.

- (a) $a^3 - y^3$ and $a^4 + a^2y^2 + y^4$
(b) $x^2 - y^2 - 2y - 1$ and $x^2 - 1 + 2xy + y^2$
(c) $x^4 - 8xy^3$ and $3x^2 - 5xy - 2y^2$

Solution,

Here,

(a) First expression = $a^3 - y^3$
$$= (a)^3 - (y)^3 = (a - y)(a^2 + ay + y^2)$$

Second expression = $a^4 + a^2y^2 + y^4$
$$\begin{aligned} &= (a^2)^2 + (y^2)^2 + a^2y^2 \\ &= (a^2 + y^2)^2 - 2a^2y^2 + a^2y^2 \\ &= (a^2 + y^2)^2 - a^2y^2 \\ &= (a^2 + y^2)^2 - (ay)^2 \\ &= (a^2 + y^2 + ay)(a^2 + y^2 - ay) \\ &= (a^2 + ay + y^2)(a^2 - ay + y^2) \end{aligned}$$

Common factors = $(a^2 + ay + y^2)$

Remaining factors = $(a - y)(a^2 - ay + y^2)$

So, Lowest Common Multiples (LCM) = common factors \times remaining factors

$$\begin{aligned} &= (a^2 + ay + y^2) \times (a - y) \times (a^2 - ay + y^2) \\ &= (a - y)(a^2 + ay + y^2)(a^2 - ay + y^2) \end{aligned}$$

Let the factors of first expression by set A and factors of second expression by set B and present in venn diagram,

(b) First expression = $x^2 - y^2 - 2y - 1$
$$\begin{aligned} &= x^2 - (y^2 + 2y + 1) \\ &= (x)^2 - (y + 1)^2 \\ &= (x + y + 1)(x - y - 1) \end{aligned}$$

Second expression = $x^2 - 1 + 2xy + y^2$
$$\begin{aligned} &= (x^2 + 2xy + y^2) - 1 \\ &= (x + y)^2 - (1)^2 \end{aligned}$$

$$\text{Common factors} = (x + y + 1)$$

$$\begin{aligned}\text{Remaining factors} &= (x - y - 1)(x + y - 1) \\ &= (x + y + 1)(x + y - 1)\end{aligned}$$

$$\begin{aligned}\therefore \text{LCM} &= \text{common factors} \times \text{remaining factors} \\ &= (x + y + 1) \times (x - y - 1) \times (x + y - 1) \\ &= (x + y + 1)(x - y - 1)(x + y - 1)\end{aligned}$$

$$\begin{aligned}\text{(c) First expression} &= x^4 - 8xy^3 \\ &= x(x^3 - 8y^3) = x\{(x)^3 - (2y)^3\} \\ &= x(x - 2y)(x^2 + 2xy + 4y^2)\end{aligned}$$

$$\begin{aligned}\text{Second expression} &= 3x^2 - 5xy - 2y^2 \\ &= 3x^2 - (6 - 1)xy - 2y^2 \\ &= 3x^2 - 6xy + xy - 2y^2 \\ &= 3x(x - 2y) + y(x - 2y) \\ &= (x - 2y)(3x + y)\end{aligned}$$

$$\text{Common factors} = (x - 2y)$$

$$\text{Remaining factors} = x(x^2 + 2xy + 4y^2)(3x + y)$$

$$\begin{aligned}\therefore \text{LCM} &= \text{common factors} \times \text{remaining factors} \\ &= (x - 2y) \times x \times (3x + y) \times (x^2 + 2xy + 4y^2) \\ &= x(x - 2y)(3x + y)(x^2 + 2xy + 4y^2)\end{aligned}$$

Example 2

Find the LCM of following expressions:

- (a) $(x^2 + xy + y^2)^3$, $x^3 - y^3$ and $x^4 + x^2y^2 + y^4$
- (b) $8x^3 + 125y^3$, $4x^3 - 10x^2y + 25xy^2$ and $16x^4 + 100x^2y^2 + 625y^4$
- (c) $3y^3 + 14y^2 - 5y$, $y^4 + 125y$ and $y^5 + 25y^3 + 625y$

Solution,

Here,

$$\begin{aligned}\text{(a) First expression} &= (x^2 + xy + y^2)^3 \\ &= (x^2 + xy + y^2)(x^2 + xy + y^2)(x^2 + xy + y^2)\end{aligned}$$

$$\begin{aligned}
 \text{Second expression} &= x^3 - y^3 \\
 &= (x)^3 - (y)^3 \\
 &= (x - y)(x^2 + xy + y^2)
 \end{aligned}$$

$$\begin{aligned}
 \text{Third expression} &= x^4 + x^2y^2 + y^4 \\
 &= (x^2)^2 + (y^2)^2 + x^2y^2 \\
 &= (x^2 + y^2)^2 - 2 \cdot x^2y^2 + x^2y^2 \\
 &= (x^2 + y^2)^2 - x^2y^2 \\
 &= (x^2 + y^2)^2 - (xy)^2 \\
 &= (x^2 + y^2 + xy)(x^2 + y^2 - xy) \\
 &= (x^2 + xy + y^2)(x^2 - xy + y^2)
 \end{aligned}$$

$$\text{Common factors} = (x^2 + xy + y^2)$$

$$\text{Remaining factors} = (x^2 + xy + y^2)(x^2 + xy + y^2)(x - y)(x^2 - xy + y^2)$$

$$\begin{aligned}
 \therefore \text{LCM} &= \text{common factors} \times \text{remaining factors} \\
 &= (x^2 + xy + y^2) \times (x - y) \times (x^2 - xy + y^2) \times (x^2 + xy + y^2) \times (x^2 + xy + y^2) \\
 &= (x - y)(x^2 + xy + y^2)^3(x^2 - xy + y^2)
 \end{aligned}$$

$$\begin{aligned}
 \text{(b) First expression} &= 8x^3 + 125y^3 \\
 &= (2x)^3 + (5y)^3 \\
 &= (2x + 5y)(4x^2 - 10xy + 25y^2)
 \end{aligned}$$

$$\text{Second expression} = 4x^3 - 10x^2y + 25xy^2 = x(4x^2 - 10xy + 25y^2)$$

$$\begin{aligned}
 \text{Third expression} &= 16x^4 + 100x^2y^2 + 625y^4 \\
 &= (4x^2)^2 + (25y^2)^2 + 100x^2y^2 \\
 &= (4x^2 + 25y^2)^2 - 2 \cdot 4x^2 \cdot 25y^2 + 100x^2y^2 \\
 &= (4x^2 + 25y^2)^2 - 100x^2y^2 \\
 &= (4x^2 + 25y^2)^2 - (10xy)^2 \\
 &= (4x^2 + 25y^2 + 10xy)(4x^2 + 25y^2 - 10xy) \\
 &= (4x^2 + 10xy + 25y^2)(4x^2 - 10xy + 25y^2)
 \end{aligned}$$

$$\begin{aligned}
 \therefore \text{LCM} &= \text{common factors} \times \text{remaining factors} \\
 &= (4x^2 - 10xy + 25y^2) \times x \times (2x + 5y) \times (4x^2 + 10xy + 25y^2) \\
 &= x(2x + 5y)(4x^2 - 10xy + 25y^2)(4x^2 + 10xy + 25y^2)
 \end{aligned}$$

$$\begin{aligned}
 \text{(c) First expression} &= 3y^3 + 14y^2 - 5y \\
 &= y(3y^2 + 14y - 5) \\
 &= y\{3y^2 + (15 - 1)y - 5\} \\
 &= y(3y^2 + 15y - y - 5) \\
 &= y\{3y(y + 5) - 1(y + 5)\} \\
 &= y(y + 5)(3y - 1)
 \end{aligned}$$

$$\begin{aligned}
 \text{Second expression} &= y^4 + 125y \\
 &= y(y^3 + 125) \\
 &= y\{(y)^3 + (5)^3\} \\
 &= y(y + 5)(y^2 - 5y + 25)
 \end{aligned}$$

$$\begin{aligned}
 \text{Third expression} &= y^5 + 25y^3 + 625y = y(y^4 + 25y^2 + 625) \\
 &= y\{(y^2)^2 + (25)^2 + 25y^2\} \\
 &= y\{(y^2 + 25)^2 - 2 \cdot y^2 \cdot 25 + 25y^2\} \\
 &= y\{(y^2 + 25)^2 - 25y^2\} \\
 &= y\{(y^2 + 25)^2 - (5y)^2\} \\
 &= y\{(y^2 + 25 + 5y)(y^2 + 25 - 5y)\} \\
 &= y(y^2 + 5y + 25)(y^2 - 5y + 25)
 \end{aligned}$$

\therefore LCM = common factors \times remaining factors

$$\begin{aligned}
 &= y \times (y^2 - 5y + 25) \times (y + 5) \times (3y - 1) (y^2 + 5y + 25) \\
 &= y(y + 5)(3y - 1)(y^2 - 5y + 25)(y^2 + 5y + 25)
 \end{aligned}$$

Exercise 10.2

- Define LCM.
 - If two expressions are given, then what is the relationship between their LCM and HCF?
- Find the lowest common multiple (LCM) of given algebraic expressions:**
 - $2x(x+2)(x-2)$ and $4x^2(3x+7)(x-2)$
 - $3x^2y(x-y)(x^2+3xy+9y^2)$ and $10x(x^2+y^2)(x+y)(x-y)$
 - $(2x-y)(x^2+xy+y^2)(x^2-xy+y^2)$ and $25xy(2x-y)$
 - $8x^3y^2(a+b+1)(a-b+1)$ and $5x^3y(a+b+1)(a+b+2)$
- If HCF and LCM of two expressions are $(a+b)^2$ and $3a^2(a+b)(2a+b)$ respectively and the second expression is $3a(a+b)^2$, find the first expression.
- The two expressions are respectively $(x+5)$ and $(x+5)(x^2-5x+25)$ and HCF is $(x+5)$. Find the LCM of given expression.
- Find the LCM of following expression:**
 - x^2-x+1 and x^4+x
 - $4x+16$ and $5x+20$
 - $3x+27$ and $8x^3+72x^2$
 - $(x-y)^3$ and x^3-y^3
 - $(a+b)^3$ and a^3+b^3
 - x^4+4 and $2x^3-4x^2+4x$
 - a^4+a^2+1 and a^2-a+1
 - $x^4+x^2y^2+y^4$ and x^3-y^3
 - $1+4p+4p^2-16p^4$ and $1+2p-8p^3-16p^4$
 - x^3+x^2+x+1 and x^3-x^2+x-1
 - $y^4+(2b^2-a^2)y^2+b^4$ and $y^3-ay^2+b^2y$
 - $\frac{x^4}{y^4} + \frac{y^4}{x^4} + 1$ and $\frac{x^3}{y^3} + \frac{y^3}{x^3}$
- Find the LCM from following expressions:**
 - x^3+1 , $x^4-x^3+x^2$ and x^3-x^2+x
 - a^3+1 , a^4+a^2+1 and a^2+a+1
 - x^2-3x+2 , x^2-5x+6 and $x^2-8x+12$
 - $2x^3+16$, x^2+4x+4 and x^2+3x+2
 - x^6-1 , x^3-1 and x^4+x^2+1

- (f) $x^6 - 16x^4, x^5 + 6x^4 + 8x^3$ and $x^4 + 8x^3 + 16x^2$
 (g) $x^4 + 8x^2 + 144, x^3 + x(x + 12) + 3x^2$ and $x^3 + 12x + 4x^2$
 (h) $x^4 - 8x^2 + 196, x^3 + x(x + 14) + 5x^2$ and $2x^2 + 12x + 28$
 (i) $x^4 + 10x^2 + 169, x^3 + 4x^2 + 13x$ and $x^3 + x(x + 13) + 3x^2$
 (j) $(y + 3)^2 - 9y - 27, y^3 - 2y^2 - 15y$ and $y^5 - 13y^3 + 36y$.

7. Find LCM:

- (a) $m^2 - 10m + 24 + 6n - 9n^2, m^2 + 6mn + 9n^2 - 36$ and $m^2 + 3mn - 6m$
 (b) $x^4 - 8x^2 - 33 - 14y - y^2, x^4 + 2x^2y - 9 + y^2$ and $x^3 + xy + 3x$
 (c) $a^4 + b^2(2a^2 - 1) + b^4, a^3 - b(a + 1)(a - b) - b^3$ and $a^3 - b(a - 1)(a - b) - b^3$

Answers

2. (a) $4x^2(x - 2)(x + 2)(3x + 7)$
 (b) $30x^2y(x - y)(x + y)(x^2 + y^2)(x^2 + 3xy + 9y^2)$
 (c) $25xy(2x - y)(x^2 + xy + y^2)(x^2 - xy + y^2)$
 (d) $40x^3y^2(a + b + 1)(a - b + 1)(a + b + 2)$
3. $a(2a + b)(a + b)$
4. $(x + 5)(x^2 - 5x + 25)$
5. (a) $x(x + 1)(x^2 - x + 1)$ (b) $20(x + 4)$ (c) $24x^2(x + 9)$
 (d) $(x - y)^3(x^2 + xy + y^2)$ (e) $(a + b)^3(a^2 - ab + b^2)$
 (f) $2x(x^2 - 2x + 2)(x^2 + 2x + 2)$ (g) $(a^2 + a + 1)(a^2 - a + 1)$
 (h) $(x - y)(x^2 + xy + y^2)(x^2 - xy + y^2)$
 (i) $(1 + 2p)(1 - 2p)(1 + 2p + 4p^2)(1 + 2p - 4p^2)$
 (j) $(x + 1)(x - 1)(x^2 + 1)$
 (k) $y(y^2 + ay + b^2)(y^2 - ay + b^2)$
- (l) $\left(\frac{x}{y} + \frac{y}{x}\right)\left(\frac{x^2}{y^2} + 1 + \frac{y^2}{x^2}\right)\left(\frac{x^2}{y^2} - 1 + \frac{y^2}{x^2}\right)$
6. (a) $x^2(x + 1)(x^2 - x + 1)$
 (b) $(a + 1)(a^2 - a + 1)(a^2 + a + 1)$
 (c) $(x - 1)(x - 2)(x - 3)(x - 6)$
 (d) $2(x + 2)^2(x + 1)(x^2 - 2x + 4)$

(e) $(x^2 - 1)(x^4 + x^2 + 1)$

(f) $x^4(x^2 - 16)(x^2 + 6x + 8)$

(g) $x(x^2 + 4x + 12)(x^2 - 4x + 12)$

(h) $2x(x^2 + 6x + 14)(x^2 - 6x + 14)$

(i) $x(x^2 + 4x + 13)(x^2 - 4x + 13)$

(j) $y(y^2 - 9)(y^2 - 4)(y - 5)(y - 6)$

7. (a) $m(m + 3n - 6)(m - 3n - 4)(m + 3n + 6)$

(b) $x(x^2 + y + 3)(x^2 - y - 11)(x^2 + y - 3)$

(c) $(a - b)(a^2 + b^2 - b)(a^2 + b^2 + b)$

Lesson 11

Linear Equations

11.0 Review

The rate of a non-veg meal in a hotel is Rs. 200. Ronish needs Rs.50 additional to buy a non-veg meal other than the money he has. Express this statement can be expressed in mathematical language as, $x + \text{Rs. } 50 = \text{Rs. } 200$. Then, find the answer to the following questions in a group and answer.

- What are the variables and constants in the above statement?
- How much money does Ronish have at the beginning?
- Which mathematical symbols connect the left and right-hand sides of the statement?
- What is the power of x in the above mathematical sentence?

Discuss the above questions in a group and find the following conclusions:

In the first question, x is a variable, and Rs 50 and Rs 200 are two constants.

In the second question, Ronish has $(x) = \text{Rs } 200 - \text{Rs } 50 = \text{Rs } 150$ at the beginning.

In the third question, the left-hand and right-hand side of the expressions is connected by the equality ($=$) sign.

In the fourth question, the power of x is 1. So, the above mathematical sentence is the linear equation.

Therefore, we get $x = \text{Rs. } 150$ to solve the equation $x + \text{Rs } 50 = \text{Rs. } 200$.

11.1 Simultaneous linear equations with two variables

Activity 1

Take two equations with two variables:

$$5x + 2y = 12, 3x + 4y = 10$$

Present these two equations in a graph and find the point of intersections of given lines. Can we find the common point (point of intersection) using other methods? Discuss in your group. We use the method of solving the simultaneous equations with two variables by the graphical method in previous classes. Now, we will discuss other methods to solve the simultaneous linear equations.

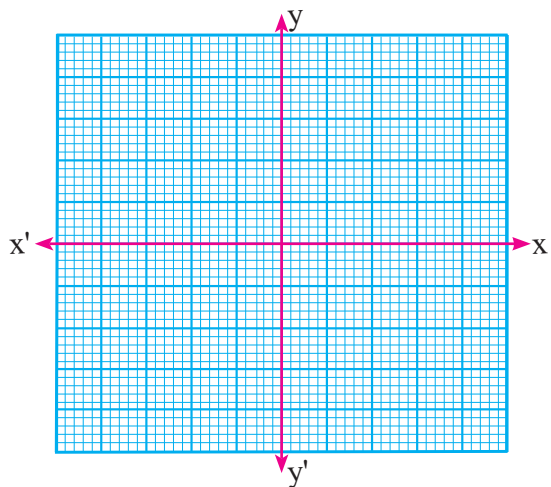

The first-degree equation is called a linear equation. Both the equations are linear, so, it gives straight lines. The solution to the equations gives the value of two variables x and y , satisfying both equations. If the variables of both equations give a fixed value, then these equations are called simultaneous linear equations. In simultaneous linear equations, there are two variables. So, these equations are called simultaneous linear equations with two variables.

11.2 Methods of solving simultaneous linear equations with two variables

Activity 2

Milan and Aashish have to share three balls. The possibilities for sharing are presented below:

Let, the number of balls for Milan = x

Number of balls for Aashish = y

Now, present the possibilities in the table;

x	3	2	1	0
y	0	1	2	3

In all the conditions, Milan and Aashish got a total of three balls.

So, $x + y = 3$ (i)

If the number of balls with Aashish is equal to four times the number of balls with Milan minus two,

$y = 4x - 2$ (ii)

We can present it in the table as,

x	1	2	0
y	2	6	-2

The two lines $x + y = 3$ and $y = 4x - 2$ are intersected at point $(1, 2)$ is the solution of the above equations (i) and (ii). Because point $(1, 2)$ satisfy both the equations.

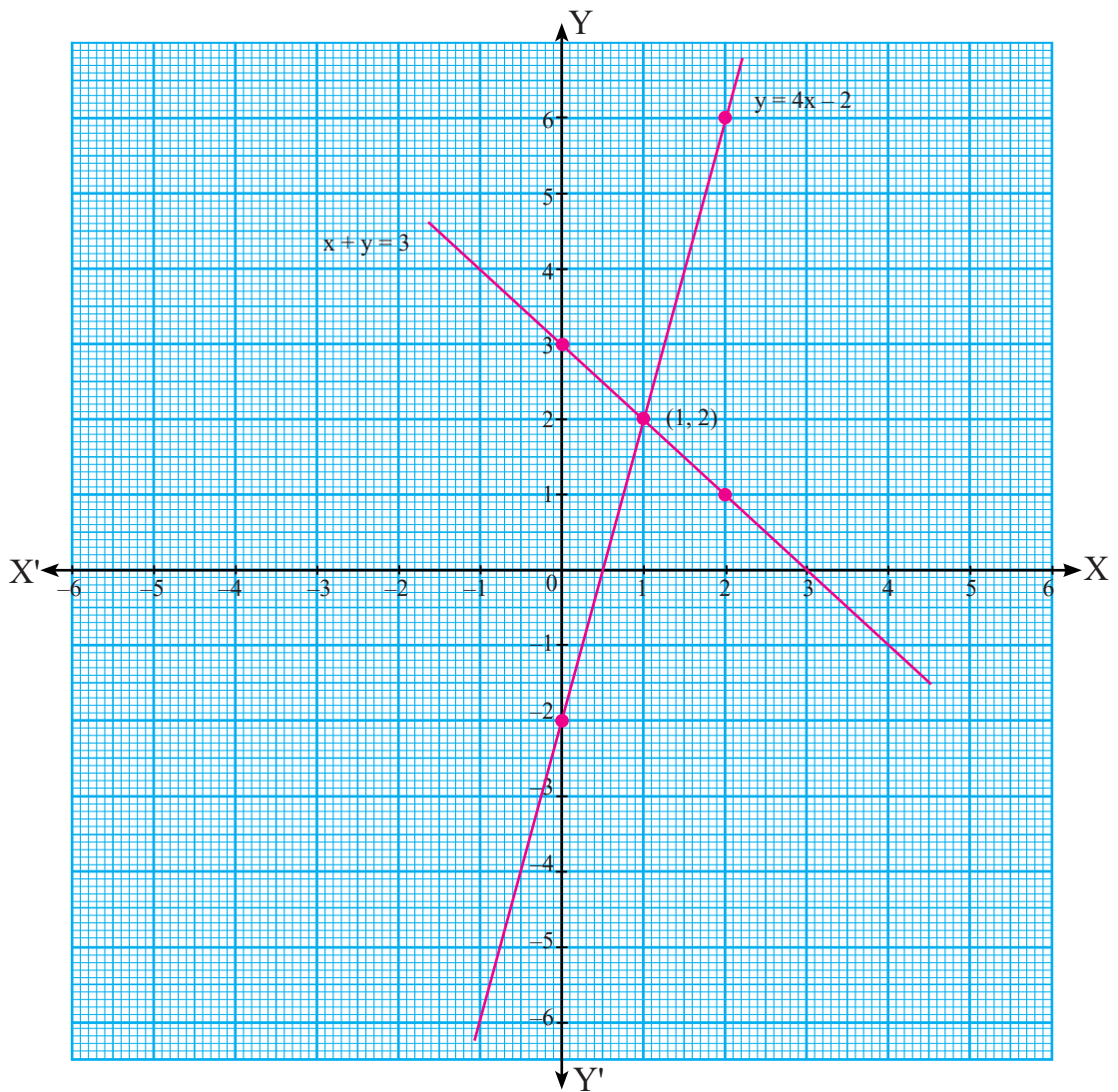

11.2.1 Substitution method

Activity 3

Take a simultaneous linear equation of two variables. i.e

$$5x + 2y = 240 \dots\dots\dots (i)$$

$$3x + 4y = 200 \dots\dots\dots (ii)$$

To solve these equations by substitution method and find the value of variables, discuss the following questions in the group and answer these questions.

- (a) From equation (i) what is the value of x in the form of y ?
- (b) Find the value of y in the form of x from equation (i).
- (c) How can we find the value of y by replacing the value of x from equation (i) with the value of x in equation (ii)? We can get the following conclusion discussing the above questions:

Here,

- (a) Express the value of y in the form of x from equation (i),

$$5x + 2y = 240$$

or, $5x = 240 - 2y$

$$x = \frac{240 - 2y}{5}$$

- (b) Likewise, express the value of x in the form of y from (i),

$$2y = 240 - 5x$$

or, $y = \frac{240 - 5x}{2}$

- (c) For question (c), observe the following steps,

Now, replace the value of x in equation (ii),

$$3\left(\frac{240 - 2y}{5}\right) + 4y = 200$$

or, $\frac{720 - 6y + 20y}{5} = 200$

or, $720 + 14y = 200 \times 5$

or, $14y = 1000 - 720$

or, $14y = 280$

or, $y = \frac{280}{14}$

$\therefore y = 20$

Now, replace the value of y in equation (ii),

or, $3x + 4 \times 20 = 200$

We can replacing the value of y in equation (i) or, (ii) in each case, the value of x and y becomes same.

$$\text{or, } 3x = 200 - 80$$

$$\text{or, } 3x = 120$$

$$\text{or, } x = \frac{120}{3}$$

$$x = 40$$

Note: Both the equations (i) and (ii) are valid if we replacing the value of x and y . Put $x = 40$ and $y = 20$ in both equations and check the results:

Put the values of x and y in equation (i) and check,

$$5x + 2y = 240$$

$$\text{or, } 5 \times 40 + 2 \times 20 = 240$$

$$\text{or, } 200 + 40 = 240$$

$$\text{or, } 240 = 240$$

$$\therefore \text{ LHS} = \text{RHS}$$

Put the value of x and y in equation (ii) and check,

$$3x + 4y = 200$$

$$\text{or, } 3 \times 40 + 4 \times 20 = 200$$

$$\text{or, } 120 + 80 = 200$$

$$\text{or, } 200 = 200$$

$$\therefore \text{ LHS} = \text{RHS}$$

So, the value of x and y satisfies both the equations.

11.2.2 Elimination method

Activity 4

Bipana pays Rs 100 for 4 small and 3 large-size copies, and Ramila pays Rs. 90 for 5 small and 2 large-size copies. Answer the following questions from the group discussion.

- Write the above statements in mathematical sentences.
- How can we find the unit price of large and small size copies by the elimination method?
- How can we make the coefficient of any one variable same after converting the above statements into mathematical sentences?
- Can we solve these equations by the replacement method as well?
- Does the result become the same using another method?

We can get the following conclusion discussing the above questions:

According to the first question,

Let the price of small copies is Rs. x and the price of large copies is Rs. y ; we can make equation from given conditions as:

$$4x + 3y = 100 \dots (i)$$

$$5x + 2y = 90 \dots\dots (ii)$$

Multiplying equation (i) by 2 and equation (ii) by 3, to replace value of y ,

$$[4x + 3y = 100] \times 2$$

$$8x + 6y = 200 \dots\dots\dots (iii)$$

$$\text{and } [5x + 2y = 90] \times 3$$

$$15x + 6y = 270 \dots\dots\dots (iv)$$

\therefore Make same coefficient of any variable by multiplying fixed numbers on both equations. Performed addition if the signs are different and subtraction if the signs are same.

Subtracting equation (iv) from equation (iii),

$$15x + \cancel{6y} = 270$$

$$8x + \cancel{6y} = 200$$

$$\begin{array}{r} - \\ - \\ \hline 7x = 70 \end{array}$$

$$\text{or, } x = \frac{70}{7}$$

$$\therefore x = 10$$

\therefore The coefficient of y in both equations are equal, and same in sign and subtraction is performed to eliminate.

Again, replacing the value of x in equation (ii),

$$5x + 2y = 90$$

$$\text{or, } 5 \times 10 + 2y = 90$$

$$\text{or, } 2y = 90 - 50$$

$$\text{or, } 2y = 40$$

$$y = \frac{40}{2}$$

$$\therefore y = 20$$

Hence, the price of small copies is Rs. 10 per pieces and the price of large copies is Rs. 20 per pieces.

We can use replacement method to solve the equations. The value of x and y becomes same, if we use any method to solve the equations.

To solve the equations by elimination method, the coefficient of x on both equations should be made the same if we eliminate x and the coefficient of y on both equations should be made the same if we eliminate y .

Then, the sign of the variables should be different for the variable to be eliminated.

The method of finding the value of one variable by eliminating another variable in simultaneous linear equations is called elimination method.

Example 1

Solve the simultaneous equations and check the result using elimination method.

$$11x + 17y - 67 = 0 \text{ and } 17x + 11y - 73 = 0$$

Solution,

Here, given equations are:

$$11x + 17y - 67 = 0 \text{ (i)}$$

$$17x + 11y - 73 = 0 \text{ (ii)}$$

Multiplying equation (i) by 11 and equation (ii) by 17, then subtracting (ii) from (i),

$$121x + 187y - 737 = 0$$

$$289x + 187y - 1241 = 0$$

$$\begin{array}{r} - \quad - \quad + \\ \hline -168x + 504 = 0 \end{array}$$

$$\text{or, } -168x = -504$$

$$\text{or, } x = \frac{-504}{-168} = 3$$

$$\therefore x = 3$$

Again, replacing the value of x in equation (i),

$$11x + 17y - 67 = 0$$

$$\text{or, } 11 \times 3 + 17y - 67 = 0$$

$$\text{or, } 33 + 17y = 67$$

$$\text{or, } 17y = 67 - 33$$

$$\text{or, } y = \frac{34}{17}$$

$$\therefore y = 2$$

Now put $x = 3$ and $y = 2$ and check the result from equation (i),

$$11x + 17y - 67 = 0$$

$$\text{or, } 11 \times 3 + 17 \times 2 - 67 = 0$$

$$\text{or, } 33 + 34 - 67 = 0$$

$$\text{or, } 67 - 67 = 0$$

$$\text{or, } 0 = 0$$

$$\therefore \text{ LHS} = \text{RHS}$$

Again from equation (ii),

$$17x + 11y - 73 = 0$$

$$\text{or, } 17 \times 3 + 11 \times 2 - 73 = 0$$

$$\text{or, } 51 + 22 - 73 = 0$$

$$\text{or, } 73 - 73 = 0$$

$$0 = 0$$

$$\therefore \text{ LHS} = \text{RHS}$$

The value of x and y satisfy both the equations. So, the result is correct.

Exercise 11.1

1. Solve the following simultaneous linear equations using substitution method:

(a) $3x + 5y = 31$ and $2x - y = 12$

(b) $5x + 6y = 27$ and $3x + 4y = 17$

(c) $3x - 2y = 11$ and $x + 3y = 11$

(d) $3x - 2y = 8$ and $x + 2y = 8$

(e) $4x - 3y + 1 = 0$ and $3x + 2y - 12 = 0$

(f) $5x - y + 1 = 0$ and $2x - 5y + 51 = 0$

(g) $9x - 8y = 12$ and $2x + 3y = 17$

(h) $y = 5x - 23$ and $3x - 2y = 4$

(i) $2x - y = 7$ and $x + y = 5$

(j) $3x + 2y = 15$ and $5x - 3y - 25 = 0$

2. Solve the following pair of simultaneous linear equations and check the result using eliminations method.

(a) $x + y = 16$

$$x - y = -4$$

(c) $5x - 2y = 2$

$$2x + 3y = 16$$

(e) $9x - 8y = 12$

$$2x + 3y = 17$$

(b) $3x - 2y = 4$

$$5x - y = 23$$

(d) $2x + 5y + 7 = 0$

$$2x - 2y = 14$$

(f) $3x + 4y = 17$

$$5x + 6y = 27$$

(g) $7x + 8y = -1$	(h) $4x - 16 = 3y$
$10x + 15y = -5$	$5y = 12 - 3x$
(i) $3x - 3y + 6 = 0$	(j) $3x = 4y + 18$
$4y - 2 - 2x = 0$	$5x = 7y + 31$

3. Solve the following pairs of simultaneous linear equations:

(a) $3x + 4y = 2$	(b) $2x + 5y = 120$
$5x + 3y + 4 = 0$	$8x - 9y + 100 = 0$

(c) $\frac{6x}{5} + \frac{7y}{5} = 1$	(d) $\frac{x}{2} + \frac{y}{3} = 6$
$\frac{7x}{3} + \frac{8y}{3} = 2$	$\frac{3x}{8} + 1 = \frac{2y}{3}$

Answers

- | | | |
|------------------------|----------------------|----------------------|
| 1. (a) $x = 7, y = 2$ | (b) $x = 3, y = 2$ | (c) $x = 5, y = 2$ |
| (d) $x = 4, y = 2$ | (e) $x = 2, y = 3$ | (f) $x = 2, y = 11$ |
| (g) $x = 4, y = 3$ | (h) $x = 6, y = 7$ | (i) $x = 4, y = 1$ |
| (j) $x = 5, y = 0$ | | |
| 2. (a) $x = 6, y = 10$ | (b) $x = 6, y = 7$ | (c) $x = 2, y = 4$ |
| (d) $x = 4, y = -3$ | (e) $x = 4, y = 3$ | (f) $x = 3, y = 2$ |
| (g) $x = 1, y = -1$ | (h) $x = 4, y = 0$ | (i) $x = -3, y = -1$ |
| (j) $x = 2, y = -3$ | | |
| 3. (a) $x = -2, y = 2$ | (b) $x = 10, y = 20$ | (c) $x = 2, y = -1$ |
| (d) $x = 8, y = 6$ | | |

11.2.3 Word problems related to simultaneous equation

Activity 1

The sum of present age of a teacher and a student is 36 years. The age of teacher is three times the age of his student. Find the present age of the teacher and his students discussing in your group.

The conclusion of one group is:

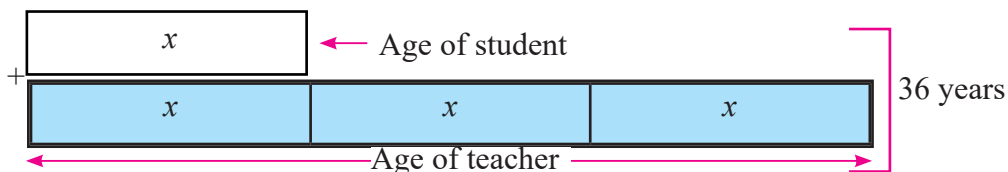

$$4x = 36$$

$$x = \frac{36}{4}$$

$$x = 9$$

So, age of student (x) = 9 years

$$\text{Age of teacher } (3x) = 3 \times 9 = 27 \text{ years}$$

Hence, present age of teacher = 27 years

present age of students = 9 years

The conclusion of second group (Alternative method)

Let, present age of teacher = x years

present age of student = y years

From the first condition,

$$x + y = 36$$

$$x = 36 - y \text{ (i)}$$

From the second condition,

$$x = 3y \text{ (ii)}$$

From the equation (i) and (ii)

$$36 - y = 3y$$

or, $36 = 4y$

or, $y = \frac{36}{4}$

$$\therefore y = 9$$

Replacing the value of y in equation (ii),

$$x = 3 \times 9 = 27$$

Hence, present age of teacher = 27 years

present age of student = 9 years

The conclusion of third group

Let, present age of student = x years

present age of teacher = $3x$ years

By question,

$$x + 3x = 36$$

or, $4x = 36$

or, $x = \frac{36}{4}$
 $x = 9$

So, present age of student = 9 years

present age of teacher = 3×9 years = 27 years.

Example 1

If the sum of opposite angles of a parallelogram is 150° and their difference is 48° , find the measurement value of angles.

Solution,

Here, opposite angles are x and y . (by figure)

From first condition, $x + y = 150^\circ$

$$x = 150^\circ - y \dots\dots\dots (i)$$

From the second condition,

$$x - y = 48^\circ \dots (ii) \quad [\because \text{When } x > y]$$

From the equation (i) and (ii),

$$150^\circ - y - y = 48^\circ$$

or, $150^\circ - 2y = 48^\circ$

or, $150^\circ - 48^\circ = 2y$

or, $102^\circ = 2y$

$$y = \frac{102^\circ}{2} = 51^\circ$$

put, $y = 51^\circ$ in equation (i), we get

$$x = 150^\circ - 51^\circ = 99^\circ$$

So, the angles are 99° and 51° .

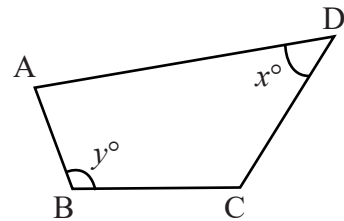

Alternative Method

Here, by question, one angle is 48° more than the other angle.

$$\text{or, } x + 48 + x = 150$$

$$\text{or, } 2x = 150 - 48$$

$$\text{or, } x = 51^\circ$$

So, small angle is $= x = 51^\circ$

Other angle is $= x + 48 = 51 + 48 = 99^\circ$

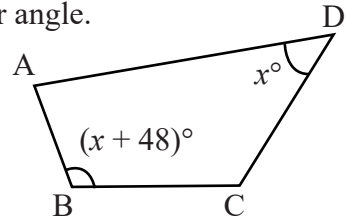

Example 2

Manish and Sima bought equal number of copies with same shape and size at the beginning of class 9. At the end of the session, Manish and Sima finished 25 and 31 copies respectively and number of copies remained with Manish is two times the copies remained with Sima. Find the number of copies that Sima and Manish buy at the beginning:

Solution,

Here,

Suppose, number of copies with Manish at beginning $= x$

Number of copies with Sima $= y$

From the first condition,

$$x = y \dots\dots\dots (i)$$

From the second condition,

$$x - 25 = 2(y - 31)$$

$$\text{or, } x - 25 = 2y - 62$$

$$\text{or, } x = 2y - 62 + 25$$

$$x = 2y - 37 \dots\dots\dots (ii)$$

Replacing the value of x in equation (ii) from (i),

$$y = 2y - 37$$

$$\text{or, } 37 = 2y - y$$

$$\text{or, } y = 37$$

Putting value of y in equation (i),

$$x = 37$$

So, number of copies with Sima at beginning $(y) = 37$

Number of copies with Manish at the beginning $(x) = 37$

Solving by model drawing method,

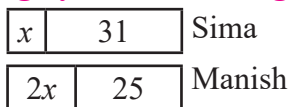

$$2x + 25 = x + 31$$

$$\text{or, } 2x - x = 31 - 25$$

$$\text{or, } x = 6$$

So, number of copies with Sima at the beginning is $x + 31 = 6 + 31 = 37$.

Number of copies with Manish at the beginning = 37

Alternative Method

Let, number of copies with Sima and Manish at the beginning =

x

The conditions after finishing 25 by Sima and 31 copies by Manish is,

$$2(x - 31) = x - 25$$

$$\text{or, } 2x - 62 = x - 25$$

$$\text{or, } 2x - x = 62 - 25$$

$$\text{or, } x = 37$$

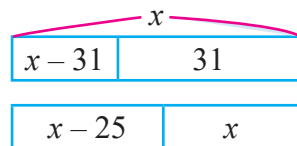

So, number of copies with Sima and Manish at the beginning is = 37.

Example 3

The present age of a mother is 3 times as her son has now. After 12 years The age of mother will be one year less than the two times of her son's age. Find the present age of mother and his son:

Solution,

Here, present age of mother = x years

present age of son = y years

From the first condition,

$$x = 3y \text{ (i)}$$

From the second condition,

$$x + 12 = 2(y + 12) - 1$$

$$\text{or, } x + 12 = 2y + 24 - 1$$

$$\text{or, } x = 2y + 23 - 12$$

$$\text{or, } x = 2y + 11 \text{ (ii)}$$

Replacing the value of x in equation (i) we have,

$$3y = 2y + 11$$

$$\text{or, } 3y - 2y = 11$$

$$\therefore y = 11$$

Putting the value of y in equation (i), we get,

$$x = 3y = 3 \times 11 = 33$$

Hence, present age of mother (x) = 33 years

and present age of son (y) = 11 years

Alternative Method

Let age of son = x years

age of mother = $3x$ years

From first condition,

$$\{(x + 12) \times 2\} - 1 = 3x + 12$$

$$\text{or, } 2x + 23 = 3x + 12$$

$$\therefore x = 11$$

So, age of son (x) = 11 years

age of mother ($3x$) = 33 years

Alternative Method

Now

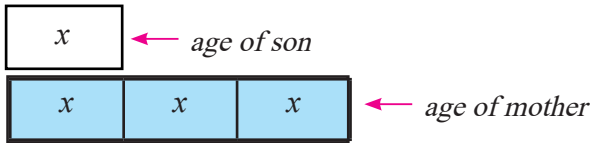

12 years hence

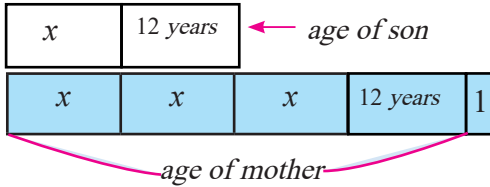

According to the question, the age of mother in 12 years time will be 1 year less than 2 times of his son's age. So, added 1 to make the mother's age 2 times than his son.

$$\text{Now, } 2(x + 12) = 3x + 12 + 1$$

$$\text{or, } 2x + 24 = 3x + 13$$

$$\text{or, } x = 11$$

Hence, present age of son = $x = 11$ years

$$\text{present age of mother} = 3x = 3 \times 11 = 33 \text{ years}$$

Example 4

The result of a fraction multiplying its numerator by 4 and subtracting 2 from denominator becomes 2. The result becomes $\frac{9}{7}$ if 15 is added on the numerator and 2 is subtracted from two times of the denominator. Find the fraction:

Solution,

Here, the fraction is $\frac{x}{y}$ where, x is numerator and y is denominator.

From the first condition,

$$\frac{x \times 4}{y - 2} = 4$$

$$\text{or, } 4x = 2(y - 2)$$

$$\text{or, } x = \frac{2(y - 2)}{4} = 4$$

$$\text{or, } x = \frac{y-2}{2} \dots\dots\dots (i)$$

From the second condition,

$$\frac{x+15}{2y-2} = \frac{9}{7}$$

$$\text{or, } 7x + 105 = 18y - 18$$

$$\text{or, } 7x = 18y - 18 - 105$$

$$\text{or, } 7x = 18y - 123$$

$$x = \frac{18y + 123}{7} \dots\dots\dots (ii)$$

Putting the value of x in equation (ii) we get,

$$\frac{y-2}{2} = \frac{18y+123}{7}$$

$$\text{or, } 7y - 14 = 36y - 246$$

$$\text{or, } 246 - 14 = 36y - 7y$$

$$\text{or, } 232 = 29y$$

$$\text{or, } y = \frac{232}{29} = 8$$

Putting the value of y in equation (i) then,

$$x = \frac{y-2}{2} = \frac{8-2}{2} = \frac{6}{2} = 3$$

So, the required fraction is $= \frac{x}{y} = \frac{3}{8}$

Example 5

The digit in ones place of two digits number is 3 times the digit in tens place. The sum of the number formed by interchanging its digit and the starting number is 88. Then find the starting number:

Solution,

Here, let two digits number is $= 10x + y$, where x and y are digits in tens and ones places respectively.

From the first condition,

$$3x = y$$

$$\text{or, } y = 3x \dots\dots (i)$$

From second condition,

$$(10x + y) + (10y + x) = 88$$

$$\text{or, } 10x + y + 10y + x = 88$$

$$\text{or, } 11x + 11y = 88$$

$$\text{or, } 11(x + y) = 88$$

$$\text{or, } x + y = 8 \dots\dots\dots \text{(ii)}$$

Put the value of x in equation (ii) we have,

$$\text{or, } x + 3x = 8$$

$$\text{or, } 4x = 8$$

$$\text{or, } x = \frac{8}{4} = 2$$

Put the value of x in equation (i),

$$y = 3x = 3 \times 2 = 6$$

Hence the starting number = $10x + y = 10 \times 2 + 6 = 26$.

Alternative Method

Sum of the starting number and the number formed by interchanging its digits is 88.

Let the possible numbers are 17 and 71, 26 and 62, 35 and 53 and 44 and 44.

From first condition,

The digit in ones place is 3 times the digit in tens place. So, the number 26 only satisfy the condition.

So, required number = 26.

Example 6

The price of 6 kg apples and 5 kg mangos is Rs. 560. Likewise, the price of 9 kg apples and 7 kg mangos is Rs. 820. Find the price of 1 kg apple and 1 kg mango each:

Solution,

Here,

Let the price of 1 kg apple is Rs. x and price of 1 kg mango is Rs. y ,

From the first condition,

$$6x + 5y = 560 \dots\dots\dots \text{(i)}$$

From the second condition,

$$9x + 7y = 820 \dots\dots\dots (ii)$$

Multiplying equation (i) by 3 and equation (ii) by 2 and subtracting (ii) from (i),

$$\begin{array}{r} 18x + 15y = 1680 \\ 18x + 14y = 1640 \\ \hline + y = 40 \end{array}$$

Putting the value of y in equation (i),

$$6x + 5y = 560$$

$$\text{or, } 6x + 5 \times 40 = 560$$

$$\text{or, } 6x = 560 - 200$$

$$\text{or, } x = \frac{360}{6} = 60$$

So, price of 1 kg apple is Rs. 60 and price of 1 kg mango is Rs. 40.

A rule for declaring some winners is made in a essay competition of a school.

Example 7

Total participants of the competition is 63. Each of the winner in that competition get Rs. 100 and each participant gets Rs. 25. The total distributed amount on that competition was Rs. 3000. Find the nuber of winners and number of participants:

Solution,

Here,

Let total number of winners is x and total number of participants only is y .

From the first condition,

$$x + y = 63$$

$$x = 63 - y \dots\dots\dots (i)$$

From the second condition,

$$100x + 25y = 3000 \dots (iii)$$

Putting the value of x in equation (ii), we get,

$$100(63 - y) + 25y = 3000$$

$$\text{or, } 6300 - 100y + 25y = 3000$$

$$\text{or, } 6300 - 3000 = 75y$$

$$\text{or, } 3300 = 75y$$

$$y = \frac{3300}{75} = 44$$

from equation (i),

$$x = 63 - 44 = 19$$

Hence, total number of winner is 19 and total number of participants only is 44.

Alternative Method

63	
$63 - x$	x
$\times 25$	$\times 100$

$$=? = 3,000$$

$$25(63 - x) + 100x = 3,000$$

$$\text{or, } 1575 - 25x + 100x = 3,000$$

$$\text{or, } 75x = 3,000 - 1575$$

$$\text{or, } 75x = 1425$$

$$\text{or, } x = 19$$

Hence, number of winners = $x = 19$

$$\text{number of participants only} = 63 - x = 63 - 19 = 44$$

Exercise 11.2

- How can we write three times and more than 1 the sum of two positive integers x and y ?
 - If the present age of Ram and Sita are x and y years respectively, write what their ages in 10 years later will be.
 - The present age of the two brothers is 15 and 11 years respectively. Write what their ages were in ten years ago.
 - How can we represent the two-digit number with y and x in ones and tens places respectively? What is the opposite number of the given number?
- The sum of two positive integers is 128 and their difference is 16. Find the numbers.
- A number is 5 times the other. Find the numbers if the sum of them is 72.
- The sum of two acute angles of a triangle is 105° and their difference is 15° . Find the angles.
- Bishal and Sumita buy an equal number of chocolate at the same price. After eating 5 and 12 chocolates by Bishal and Sumita respectively, Bishal has two times and less than two chocolates than the Susmita has. Find the number of chocolates they have at in the beginning.
- Five years ago, the age of father was 5 times as old as his son. At present, the sum of their ages is 46 years. Find their present ages.
- 15 years ago, a father was 4 times as old as his daughter. After five years he will be twice as old as his daughter. Find their present ages.
- One year after the mother will be 4 times as old as her son. Two years ago the age of the mother was three times the age of her son will be after four years. Find their present ages.
- Three years ago, the age of Ramesh and Nimesh are in the ratio of 4:3. Three years after the ratio of their ages will be 11:9. Find their present ages.
- Ten years ago, the ratio of the age of the father and his son was 11:3. Five years after the age of father will be 10 years older than two times the age of his son. Find after how many years the age of the son will be equal to the present age of his father.

11. The sum of numerator and denominator is equal to three less than two times the denominator of a fraction. Find the fraction if 1 is subtracted from its numerator and denominator the numerator will be half of its denominator.
12. A two-digit number is three times the sum of its digits. If 45 is added to the number, the digits interchange their places. Find the number.
13. Find a two-digit number if the sum of the number and the number formed by interchanging its digit is 121 and their difference is 27.
14. The sum of the digits of a number between 10 and 100 is 9. The seven times the number is equal to the four times the number formed by interchanging its digits. Compare the digits of the number in percentage.
15. The total cost of 5 kg of onion and 7 kg of sugar is Rs 810. If the cost of 5 kg of onion is the same as the cost of 2 kg of sugar, find the cost of per kg onion and sugar.
16. A rural municipality provides rectangular land for a school. The ratio of length and breadth of the ground is 11:4. The rural municipality needs Rs. 75,000 for fencing wire of costs Rs 100 per meter for covering one round of the ground. Find the length and breadth of the ground.
17. The breadth of the playground of a school is one-third of its length. If the perimeter of the playground is 32 meters then find their length and breadth.
18. Sambridi goes to Rastra Bank to exchange Rs. 2,000 into paper notes of Rs 50 and Rs 100. The Bank provides only 25 paper notes, find how many paper notes of each category she found.

Project Work

Go to a nearby shop and ask how much the cost of half a dozen or a dozen or a full carton of any two of the goods of daily consumption. Make simultaneous equation based on these price and the unit price of those goods. What is the difference in the price of a unit if a person buys large quantity of goods and just a unit of goods or 1 kg? Prepare a report based on this.

Answers

1. (a) $3(x + y) + 1$ (b) $(x + 10)$ year and $(y + 10)$ year
(c) $(15 - m)$ year and $(11 - m)$ year (d) $10x + y, 10y + x$
2. 72, 56 3. 12, 60 4. 60, 45
5. 21, 21 6. 35 year, 11 year 7. 55 year, 25 year
8. 47 year 11 year 9. 19 year, 15 year 10. 40 year
11. $\frac{4}{7}$ 12. 27 13. 74
14. 100 % bigger or 50% smaller
15. Onion Rs. 36 per kg Sugar Rs. 90 per kg
16. 275 m, 100 m
17. 12 m, 4 m
18. 10 of Rs. 50 and 15 of Rs. 100

12.0 Review

The distance between the Earth and the Sun is 1,49,60,00,00,000 km. Likewise, the velocity of light is 30,00,00,000 m/s. Based on this fact, discuss the following questions and present the conclusions in your class:

- How can we write the distance between the Earth and the Sun in short form?
- How can we express the velocity of light in short form?
- Which format is used to write large numbers in short form?

12.1 Indices

Activity 1

Make different groups in your class with appropriate numbers. Take one square cardboard and one solid cube to each group and discuss the following questions and present the conclusions in class:

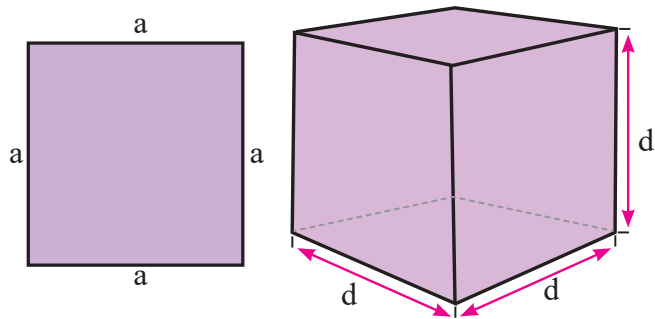

- What is the area of square cardboard?
- What is the volume of the cube? How can we calculate?
- Write the base and index from area and volume on (a) and (b).

The area of square cardboard = $a \times a = a^2$ where a is base and 2 is the index. Likewise, the volume of cube = $d \times d \times d = d^3$ where d is the base and 3 is the index.

If any number or variable is multiplied by the same number or variable two or more than two times, this multiplication can be expressed in an index. Likewise, if a is multiplied by n times then

$$a \times a \times a \times \dots (n \text{ times}) = a^n$$

12.2 Laws of indices

(a) Multiplication Law of indices

$a^m \times a^n = a^{m+n}$ where m and n are positive integers.

(b) Division law of Indices

$$\frac{a^m}{a^n} = a^{m-n} \text{ where } m > n$$

$$a^m \div a^n = \frac{1}{a^{n-m}} \text{ where } n > m$$

(c) Power law of indices

$$(a^m)^n = a^{m \times n}, (ab)^m = a^m b^m, \left(\frac{a}{b}\right)^m = \frac{a^m}{b^m}$$

(d) Law of Negative Indices

$$a^{-m} = \frac{1}{a^m}$$

$$\text{or, } a^m = \frac{1}{a^{-m}}$$

(e) Law of zero index

$$a^0 = 1, b^0 = 1, x^0 = 1, (abx)^0 = 1$$

(f) Root law of indices

$$\sqrt[n]{a^m} = a^{\frac{m}{n}}$$

12.3 Simplification of problems related to indices

Activity 2

Discuss the following questions and present the conclusions.

- What is the difference between 10^4 and $\frac{1}{10 \times 10 \times 10 \times 10}$?
- Does $(6)^3$ and $(6)^{-3}$ have the same values?
- Does $\sqrt[3]{64}$ and $\sqrt{64}$ give the same value?

In the first question, in 10^4 , 10 is the base, and 4 is the index. In $\frac{1}{10^4} = 10^{-4}$, 10 is the base and the index is -4

In the second question, $(6)^3 = 216$ and $6^{-3} = \frac{1}{6^3} = \frac{1}{216}$ don't have the same value.

In the third question $\sqrt[3]{64} = (4^3)^{\frac{1}{3}} = 4$ and $\sqrt{64} = (8^2)^{\frac{1}{2}} = 8$. So, it has different values.

$a^m \neq \frac{1}{a^m}$ similarly a^m and $(a)^{-m}$ gives different values. $\sqrt[n]{a^m}$ and $\sqrt[m]{a^n}$ also gives different results.

Example 1

Find the value of :

(a) $(16)^{\frac{3}{2}}$ (b) $\left(\frac{27}{64}\right)^{\frac{-2}{3}}$ (c) $\sqrt[3]{\sqrt{64}}$

Solution,

Here,

(a) $(16)^{\frac{3}{2}} = (4^2)^{\frac{3}{2}} = 4^{2 \times \frac{3}{2}} = 4^3 = 64$

(b) $\left(\frac{27}{64}\right)^{\frac{-2}{3}} = \left(\frac{3^3}{4^3}\right)^{\frac{-2}{3}} = \frac{3^{3 \times \frac{-2}{3}}}{4^{3 \times \frac{-2}{3}}} = \frac{3^{-2}}{4^{-2}} = \frac{4^2}{3^2} = \frac{16}{9}$

(c) $\sqrt[3]{\sqrt{64}} = \sqrt[3]{\sqrt{8^2}} = \sqrt[3]{8} = \sqrt[3]{2^3} = 2^{\frac{3}{3}} = 2$

Example 2

Simplify:

(a) $\left(\frac{27}{8}\right)^{\frac{1}{3}} \times \left\{ \left(\frac{243}{32}\right)^{\frac{1}{5}} \div \left(\frac{2}{3}\right)^{-2} \right\}$

(b) $(8x^3 y^9)^{\frac{1}{3}} \div (16x^4 y^{12})^{\frac{1}{4}}$

(c) $\sqrt{(x+y)^{-3}} \times (x+y)^{\frac{2}{3}}$

Solution,

Here,

$$\begin{aligned} \text{(a)} \quad & \left(\frac{27}{8}\right)^{\frac{1}{3}} \times \left\{ \left(\frac{243}{32}\right)^{\frac{1}{5}} \div \left(\frac{2}{3}\right)^{-2} \right\} && \left[\left\{ \left(\frac{a}{b}\right)^n = \left(\frac{b}{a}\right)^{-n} \right\} \right] \\ & = \left(\frac{3}{2}\right)^{3 \times \frac{1}{3}} \times \left\{ \left(\frac{3}{2}\right)^{5 \times \frac{1}{5}} \div \left(\frac{3}{2}\right)^2 \right\} = \frac{3}{2} \times \left\{ \frac{3}{2} \times \left(\frac{2}{3}\right)^2 \right\} = \frac{3}{2} \times \frac{3}{2} \times \left(\frac{3}{2}\right)^{-2} \\ & = \left(\frac{3}{2}\right)^{1+1-2} = \left(\frac{3}{2}\right)^0 = 1 \quad [\because a^0 = 1] \end{aligned}$$

$$\begin{aligned} \text{(b)} \quad & (8x^3y^9)^{\frac{1}{3}} \div (16x^4y^{12})^{\frac{1}{4}} \\ & = \{2^3 x^3 y^9\}^{\frac{1}{3}} \div \{2^4 x^4 y^{12}\}^{\frac{1}{4}} = 2^{3 \times \frac{1}{3}} x^{3 \times \frac{1}{3}} \div 2^{4 \times \frac{1}{4}} x^{4 \times \frac{1}{4}} y^{12 \times \frac{1}{4}} \\ & = 2xy^3 \div 2xy^3 = \frac{2xy^3}{2xy^3} = 2^{1-1} x^{1-1} y^{3-3} = 2^0 x^0 y^0 = 1 \times 1 \times 1 = 1 \end{aligned}$$

$$\begin{aligned} \text{(c)} \quad & \sqrt{(x+y)^{-3}} \times (x+y)^{\frac{2}{3}} && [\because \sqrt[n]{a^m} = a^{\frac{m}{n}}] \\ & = (x+y)^{-\frac{3}{2}} \times (x+y)^{\frac{2}{3}} = (x+y)^{-\frac{3}{2} + \frac{2}{3}} = (x+y)^{\frac{-9+4}{6}} = (x+y)^{\frac{-5}{6}} = \frac{1}{(x+y)^{\frac{5}{6}}} \end{aligned}$$

Example 3

Simplify:

$$\text{(a)} \quad \left(\frac{x^a}{x^b}\right)^{a+b} \times \left(\frac{x^b}{x^c}\right)^{b+c} \times \left(\frac{x^c}{x^a}\right)^{c+a}$$

$$\text{(b)} \quad \left(\frac{x^l}{x^m}\right)^{l^2+lm+n^2} \times \left(\frac{x^m}{x^n}\right)^{m^2+mn+n^2} \times \left(\frac{x^n}{x^l}\right)^{n^2+nl+l^2}$$

Solution,

Here,

$$(a) \left(\frac{x^a}{x^b}\right)^{a+b} \times \left(\frac{x^b}{x^c}\right)^{b+c} \times \left(\frac{x^c}{x^a}\right)^{c+a}$$

$$= (x^{a-b})^{a+b} \times (x^{b-c})^{b+c} \times (x^{c-a})^{c+a} \left[\because \frac{x^m}{x^n} = x^{m-n} \right]$$

$$= x^{a^2-b^2} \times x^{b^2-c^2} \times x^{c^2-a^2} \left[\because (a-b)(a+b) = a^2 - b^2 \right]$$

$$= x^{a^2-b^2+b^2-c^2+c^2-a^2} \left[\because x^m \times x^n = x^{m+n} \right]$$

$$= x^0 = 1$$

$$(b) \left(\frac{x^l}{x^m}\right)^{l^2+lm+m^2} \times \left(\frac{x^m}{x^n}\right)^{m^2+mn+n^2} \times \left(\frac{x^n}{x^l}\right)^{n^2+nl+l^2}$$

$$= (x^{l-m})^{l^2+lm+m^2} \times (x^{m-n})^{m^2+mn+n^2} \times (x^{n-l})^{n^2+nl+l^2}$$

$$\left[\because x^m \div x^n = x^{m-n} \right]$$

$$= x^{(l-m)(l^2+lm+m^2)} \times x^{(m-n)(m^2+mn+n^2)} \times x^{(n-l)(n^2+nl+l^2)}$$

$$\left[\because (x^m)^n = x^{mn} \right]$$

$$= x^{(l^3-m^3)} \times x^{(m^3-n^3)} \times x^{(n^3-l^3)} \left[\because a^3 - b^3 = (a-b)(a^2+ab+b^2) \right]$$

$$= x^{l^3-m^3+m^3-n^3+n^3-l^3} \left[\because x^m \times x^n \times x^p = x^{m+n+p} \right]$$

$$= x^0 = 1$$

$$\left[\because a^0 = 1 \right]$$

Example 4

Prove that:

$$(a) \sqrt{\frac{bc}{x^{b/c}}} \times \sqrt{\frac{ca}{x^{c/a}}} \times \sqrt{\frac{ab}{x^{a/b}}} = 1$$

$$(b) \frac{1}{1+a^{x-y}+a^{z-y}} + \frac{1}{1+a^{y-z}+a^{x-z}} + \frac{1}{1+a^{z-x}+a^{y-x}} = 1$$

Solution,

Here,

$$\begin{aligned} \text{(a) L.H.S} &= \sqrt[bc]{\frac{x^{b/c}}{x^{c/b}}} \times \sqrt[ca]{\frac{x^{c/a}}{x^{a/c}}} \times \sqrt[ab]{\frac{x^{a/b}}{x^{b/a}}} \\ &= \left(\frac{x^{b/c}}{x^{c/b}}\right)^{1/bc} \times \left(\frac{x^{c/a}}{x^{a/c}}\right)^{1/ac} \times \left(\frac{x^{a/b}}{x^{b/a}}\right)^{1/ab} \quad \left[\because \sqrt[n]{a^m} = a^{\frac{m}{n}}\right] \\ &\quad \left[\because (x^m)^n = x^{m \times n}\right] \\ &= \frac{x^{b/c \times 1/bc}}{x^{c/b \times 1/bc}} \times \frac{x^{c/a \times 1/ca}}{x^{a/c \times 1/ca}} \times \frac{x^{a/b \times 1/ab}}{x^{b/a \times 1/ab}} \\ &= \frac{x^{1/c^2}}{x^{1/b^2}} \times \frac{x^{1/a^2}}{x^{1/c^2}} \times \frac{x^{1/b^2}}{x^{1/a^2}} \quad \left[\because \frac{a^m}{a^n} = a^{m-n}\right] \\ &= x^{1/c^2 - 1/b^2} \times x^{1/a^2 - 1/c^2} \times x^{1/b^2 - 1/a^2} \quad \left[\because a^0 = 1\right] \\ &= x^{1/c^2 - 1/b^2 + 1/a^2 - 1/c^2 + 1/b^2 - 1/a^2} \\ &= x^0 = 1 = \text{R.H.S.} \end{aligned}$$

(b) L.H.S

$$\begin{aligned} &= \frac{1}{1 + a^{x-y} + a^{z-y}} + \frac{1}{1 + a^{y-z} + a^{x-z}} + \frac{1}{1 + a^{z-x} + a^{y-x}} \quad \left[\because a^{m-n} = \frac{a^m}{a^n}\right] \\ &= \frac{1}{1 + \frac{a^x}{a^y} + \frac{a^z}{a^y}} + \frac{1}{1 + \frac{a^y}{a^z} + \frac{a^x}{a^z}} + \frac{1}{1 + \frac{a^z}{a^x} + \frac{a^y}{a^x}} \\ &= \frac{1}{\frac{a^y + a^x + a^z}{a^y}} + \frac{1}{\frac{a^z + a^y + a^x}{a^z}} + \frac{1}{\frac{a^x + a^z + a^y}{a^x}} \\ &= \frac{a^y}{a^y + a^x + a^z} + \frac{a^z}{a^y + a^z + a^x} + \frac{a^x}{a^y + a^z + a^x} \\ &= \frac{a^y + a^z + a^x}{a^y + a^z + a^x} = 1 = \text{R.H.S} \end{aligned}$$

Example 5

Simplify:

$$\frac{\left(p^2 - \frac{1}{q^2}\right)^x \times \left(p - \frac{1}{q}\right)^{y-x}}{\left(q^2 - \frac{1}{p^2}\right)^y \times \left(q + \frac{1}{p}\right)^{x-y}}$$

Solution,

Here,

$$\begin{aligned} & \frac{\left(p^2 - \frac{1}{q^2}\right)^x \times \left(p - \frac{1}{q}\right)^{y-x}}{\left(q^2 - \frac{1}{p^2}\right)^y \times \left(q + \frac{1}{p}\right)^{x-y}} \\ &= \frac{\left(p + \frac{1}{q}\right)^x \left(p - \frac{1}{q}\right)^x \times \left(p - \frac{1}{q}\right)^{y-x}}{\left(q + \frac{1}{p}\right)^y \left(q - \frac{1}{p}\right)^y \times \left(q + \frac{1}{p}\right)^{x-y}} \\ &= \frac{\left(p + \frac{1}{q}\right)^x \left(p - \frac{1}{q}\right)^{x+y-x}}{\left(q + \frac{1}{p}\right)^{y+x-y} \left(q - \frac{1}{p}\right)^y} \\ &= \frac{\left(\frac{pq+1}{q}\right)^x \left(\frac{pq-1}{q}\right)^y}{\left(\frac{pq+1}{p}\right)^x \left(\frac{pq-1}{p}\right)^y} \\ &= \left(\frac{pq+1}{q} \times \frac{p}{pq+1}\right)^x \times \left(\frac{pq-1}{q} \times \frac{p}{pq-1}\right)^y \\ &= \left(\frac{p}{q}\right)^x \times \left(\frac{p}{q}\right)^y \\ &= \left(\frac{p}{q}\right)^{x+y} \end{aligned}$$

Example 6

If, $a + b + c = 0$ then prove that,

$$\frac{1}{1+x^a+x^{-b}} + \frac{1}{1+x^b+x^{-c}} + \frac{1}{1+x^c+x^{-a}} = 1$$

Solution,

Here,

$$a + b + c = 0$$

or, $a + b = -c$ (i)

$$\begin{aligned} \text{L.H.S} &= \frac{1}{1+x^a+x^{-b}} + \frac{1}{1+x^b+x^{-c}} + \frac{1}{1+x^c+x^{-a}} \\ &= \frac{1}{1+x^a+\frac{1}{x^b}} + \frac{1}{1+x^b+x^{a+b}} + \frac{1}{1+x^c+x^{-a}} \quad [\because \text{From equation (i)}] \\ &= \frac{1}{\frac{x^b+x^{a+b}+1}{x^b}} + \frac{1}{1+x^b+x^{a+b}} + \frac{1}{1+x^c+x^{-a}} \\ &= \frac{x^b}{x^b+1+x^{a+b}} + \frac{1}{x^b+1+x^{a+b}} + \frac{x^{a+b}}{x^{a+b}(1+x^c+x^{-a})} \\ & \qquad \qquad \qquad [\because \text{Multiply } x^{a+b} \text{ n}] \\ &= \frac{x^b+1}{x^b+1+x^{a+b}} + \frac{x^{a+b}}{x^{a+b}+x^{a+b+c}+x^{a+b-a}} \\ &= \frac{x^b+1}{x^b+1+x^{a+b}} + \frac{x^{a+b}}{x^{a+b}+1+x^b} \quad [\because x^{a+b+c} = x^0 = 1] \\ &= \frac{x^b+1}{x^b+1+x^{a+b}} + \frac{x^{a+b}}{x^b+1+x^{a+b}} \\ &= \frac{x^b+1+x^{a+b}}{x^b+1+x^{a+b}} = 1 = \text{R.H.S.} \end{aligned}$$

Exercise 12.1

1. Find the value of:

- (a) $3^5 \times 3^{-5}$ (b) $9^4 \times \frac{1}{9^3}$ (c) $5^3 \times \frac{1}{5^2}$
- (d) $(64)^{\frac{2}{3}}$ (e) $\left(\frac{81}{3}\right)^{\frac{1}{3}}$ (f) $\sqrt[3]{\frac{1}{125}}$
- (g) $\left(\frac{27}{64}\right)^{-\frac{2}{3}}$ (h) $\left\{\left(\frac{216}{125}\right)^{-\frac{1}{3}}\right\}^2$ (i) $\left(\frac{1}{128}\right)^{\frac{1}{7}} + \left(\frac{1}{64}\right)^{\frac{1}{6}}$
- (j) $\left(\frac{1}{16}\right)^{\frac{1}{4}} \times (8)^{\frac{4}{3}}$ (k) $\left(\frac{1}{3}\right)^{-3} + \left(\frac{1}{3}\right)^{-1} + \left(\frac{1}{2}\right)^{-3} + \left(\frac{1}{8}\right)^0$

2. Simplify:

- (a) $(125 m^3 \div 27b^{-3})^{-\frac{2}{3}}$ (b) $(64a^3 \div 125b^{-3})^{-\frac{2}{3}}$
- (c) $x^{a-b} \times x^{b-c} \times x^{c-a}$ (d) $x^{b^2 - c^2} \times x^{c^2 - a^2} \times x^{a^2 - b^2}$
- (e) $x^{ab} \times x^{bc} \times x^{ca} \times x^{-ab} \times x^{-bc} \times x^{-ca}$ (f) $\frac{x^{2m+3n} \times x^{3m+6n}}{x^{2m+3n} \times x^{4m-4n}}$
- (g) $\frac{a^{9n+3} \times a^{-4n}}{a^{2n+10} \times a^{3n-7}}$ (h) $\frac{7^{n+1} \times 7n^2 - 1}{7n^2 - n \times 7^{2n+2}}$

3. Find the value of:

- (a) $\left(\frac{27}{8}\right)^{-\frac{1}{3}} \left[\left(\frac{81}{16}\right)^{\frac{1}{4}} \div \left(\frac{4}{25}\right)^{-\frac{1}{2}}\right]$ (b) $\left(\frac{25}{16}\right)^{-\frac{1}{3}} \left[\left(\frac{125}{64}\right)^{\frac{1}{3}} \div \left(\frac{8}{27}\right)^{-\frac{1}{3}}\right]$
- (c) $\left(\frac{27}{8}\right)^{\frac{1}{3}} \left[\left(\frac{243}{32}\right)^{\frac{1}{5}} \div \left(\frac{2}{3}\right)^{-2}\right]$ (d) $\frac{3^4 \times 27^3 \times 9^5}{81^6 \times 3^3 \times 9^{-2}}$
- (e) $\frac{2^4 \times 8^3 \times 4^5}{16^6 \times 2^3 \times 4^{-2}}$

4. Simplify:

- (a) $\frac{1}{1+x^{a-b}} + \frac{1}{1+x^{b-a}}$ (b) $\frac{1}{1-a^{x-y}} + \frac{1}{1-a^{y-x}}$

$$(c) \frac{(x^{a+b})^2 \times (x^{b+c})^2 \times (x^{c+a})^2}{(x^a \cdot x^b \cdot x^c)^4}$$

$$(d) \frac{(a^{x+y})^3 \times (a^{y+z})^3 \times (a^{z+x})^3}{(a^x \cdot a^y \cdot a^z)^6}$$

$$(e) \frac{27^{3a+1} \times (243)^{\frac{-4a}{5}}}{9^{a+5} \times 3^{3a-7}}$$

$$(f) \frac{(32)^{\frac{2n}{5}} \times 2^{2n+1}}{4^{n+1} \times 2^{2(n-2)}}$$

5. Simplify:

$$(a) \left(\frac{x^b}{x^{-a}}\right)^{b-a} \times \left(\frac{x^a}{x^{-c}}\right)^{a-c} \times \left(\frac{x^c}{x^{-b}}\right)^{c-b}$$

$$(b) \left(\frac{x^{-b}}{x^{-a}}\right)^{a+b} \times \left(\frac{x^{-c}}{x^{-b}}\right)^{c+b} \times \left(\frac{x^{-a}}{x^{-c}}\right)^{c+a}$$

$$(c) \left(\frac{x^m}{x^{-n}}\right)^{m^2 - mn + n^2} \times \left(\frac{x^n}{x^{-l}}\right)^{n^2 - nl + l^2} \times \left(\frac{x^l}{x^{-m}}\right)^{l^2 - ml + m^2}$$

$$(d) \left(\frac{x^{a+b}}{x^c}\right)^{a-b} \times \left(\frac{x^{b+c}}{x^a}\right)^{b-c} \times \left(\frac{x^{c+a}}{x^b}\right)^{c-a}$$

$$(e) a + b\sqrt{x^a - b^2} \times b + c\sqrt{x^b - c^2} \times c + a\sqrt{x^c - a^2}$$

$$(f) \left(\frac{x^{a^2 + b^2}}{x^{-ab}}\right)^{a-b} \times \left(\frac{x^{b^2 + c^2}}{x^{-bc}}\right)^{b-c} \times \left(\frac{x^{c^2 + a^2}}{x^{-ca}}\right)^{c-a}$$

$$(g) \left(\frac{x^b}{x^c}\right)^{\frac{1}{bc}} \times \left(\frac{x^c}{x^a}\right)^{\frac{1}{ca}} \times \left(\frac{x^a}{x^b}\right)^{\frac{1}{ab}} \quad (h) \left\{ (a^x \cdot a^y)^{x-y} \left(\frac{a^y}{a^z}\right)^{y+z} \right\} \times \left(\frac{a^z}{a^x}\right)^{z+x}$$

6. Prove that:

$$(a) \sqrt[bc]{\frac{x^b}{x^c}} \times \left(\frac{x^c}{x^a}\right)^{\frac{1}{ca}} \times \sqrt[ab]{\frac{x^a}{x^b}} = 1$$

$$(b) \sqrt[ca]{\frac{x^a}{x^b}} \times \sqrt[ab]{\frac{x^b}{x^c}} \times \sqrt[bc]{\frac{x^c}{x^a}} = 1$$

$$(c) \sqrt[bc]{\frac{x^{b/c}}{x^{c/b}}} \times \sqrt[ca]{\frac{x^{c/a}}{x^{a/c}}} \times \sqrt[ab]{\frac{x^{a/b}}{x^{b/a}}} = 1$$

$$(d) \frac{1}{1+x^{a-b}+x^{c-b}} + \frac{1}{1+x^{b-c}+x^{a-c}} + \frac{1}{1+x^{c-a}+x^{b-c}} = 1$$

$$(e) \frac{\left(p + \frac{1}{q}\right)^m \times \left(p - \frac{1}{q}\right)^m}{\left(q + \frac{1}{p}\right)^m \times \left(q - \frac{1}{p}\right)^m} = \left(\frac{p}{q}\right)^{2m}$$

$$(f) \frac{\left(x^2 + \frac{1}{y^2}\right)^a \times \left(x - \frac{1}{y}\right)^{b-a}}{\left(y^2 + \frac{1}{x^2}\right)^b \times \left(y + \frac{1}{x}\right)^{a-b}} = \left(\frac{x}{y}\right)^{a+b}$$

$$(g) \frac{\left(a^2 - \frac{1}{b^2}\right)^x \times \left(a - \frac{1}{b}\right)^{y-x}}{\left(b^2 - \frac{1}{a^2}\right)^y \times \left(b + \frac{1}{a}\right)^{x-y}} = \left(\frac{a}{b}\right)^{x+y}$$

7. If, $p^3 + q^3 + r^3 = 1$, prove that:

$$\left(\frac{x^p}{x^{-q}}\right)^{p^2 - pq + q^2} \times \left(\frac{x^q}{x^{-r}}\right)^{q^2 - qr + r^2} \times \left(\frac{x^r}{x^{-p}}\right)^{r^2 - rp + p^2} = x^2$$

8. If, $x^2 + y^2 + z^2 = 2(xy + yz + zx)$, then prove that:

$$\left(\frac{a^x}{a^y}\right)^{x-y} \times \left(\frac{a^y}{a^z}\right)^{y-z} \times \left(\frac{a^z}{a^x}\right)^{z-x} = 1$$

9. If, $g + h + f = 0$ then, prove that:

$$\frac{1}{1+m^g+m^{-h}} + \frac{1}{1+m^h+m^{-f}} + \frac{1}{1+m^f+m^{-g}} = 1$$

10. If, $r + s + t = 0$ then, prove that:

$$\frac{1}{1+x^r+x^{-s}} + \frac{1}{1+x^s+x^{-t}} + \frac{1}{1+x^t+x^{-r}} = 1$$

11. If, $xyz = 1$ then, prove that:

$$\frac{1}{1+x+y^{-1}} + \frac{1}{1+y+z^{-1}} + \frac{1}{1+z+x^{-1}} = 1$$

Answer

- | | | | |
|----|--------------------------|---------------------------|--------------------------|
| 1. | (a) 1 | (b) 9 | (c) 5 |
| | (d) 16 | (e) 3 | (f) $\frac{1}{5}$ |
| | (g) $\frac{16}{9}$ | (h) $\frac{25}{36}$ | (i) 1 |
| | (j) 8 | (k) 39 | |
| 2. | (a) $\frac{9}{25m^2b^2}$ | (b) $\frac{25}{16a^2b^2}$ | (c) 1 |
| | (d) 1 | (e) 1 | (f) x^{10n-m} |
| | (g) 1 | (h) $\frac{1}{49}$ | |
| 3. | (a) $\frac{2}{5}$ | (b) $\frac{2}{3}$ | (c) 1 |
| | (d) 1 | (e) 1 | |
| 4. | (a) 1 | (b) 1 | (c) 1 |
| | (d) 1 | (e) 1 | (f) 8 |
| 5. | (a) 1 | (b) 1 | (c) $x^{2(x^3+m^3+n^3)}$ |
| | (d) 1 | (e) 1 | (f) 1 |
| | (g) 1 | (h) 1 | |

Mixed Exercise**1. Factorize the following expressions:**

- | | |
|----------------------------------|--|
| (a) $216a^3 + \frac{1}{8}$ | (b) $8x^3 - 125y^3$ |
| (c) $(x + 2)^3$ | (d) $(x - 3)^3$ |
| (e) $16m^4 - 65m^2n^2 + 49n^4$ | (f) $9x^4 - \frac{2x^2}{y^2} + \frac{1}{9y^4}$ |
| (g) $64 - 144a + 108a^2 - 27a^3$ | (h) $a^4 - 5a^2b^2 + 4b^4$ |

2. Find Highest Common Factor (HCF) of the given expressions:

- (a) $x^2 + 2x - 8 - y^2 - 6y, x^2 + 2xy + y^2 - 16, x^2 + xy + 4x$
(b) $9(a + b)^2 + a + b - 8, a^2 + 2ab + b^2 - 1, a^2 + ab + a$
(c) $x^2 - 10x + 24 + 6y - 9y^2, x^2 + 6xy + 9y^2 - 36$ and $x^2 + 3xy - 6x$
(d) $\frac{x^4}{y^4} + 1 + \frac{y^4}{x^4}, \frac{x^3}{y^3} + \frac{y^3}{x^3}$ र $\frac{x^3}{y^2} - x + \frac{y^2}{x^2}$

3. Find Lowest Common Multiple (LCM) of the given expression:

- (a) $a^5 + 2a^4 - 9a^3 - 18a^2, a^5 - 2a^4 + 8a^2 - 4a^3, a^4 - 4a^2$
(b) $x^4 - 8x^2 - 33 - 14y - y^2, (x^2 + y^2)^2 - 9, x^3 + xy + 3x$
(c) $x^2 + 2xy + y^2 - z^2, y^2 + 2yz + z^2 - x^2, z^2 + 2zx + x^2 - y^2$
(d) $a(a + c) - b(b + c), b(a + b) - c(c + a) c(b + c) - a(a + b)$
4. The HCF and LCM of two algebraic expressions are $2u + 5v$, and $3u(2u + 5v)(2u - 5v)$ respectively and if one of the expressions is $4u^2 - 25v^2$, then find the other expression.

5. Find HCF and LCM of the given expression:

- (a) $(p + 3)^3, p^2 + 6p + 9, 2p^3 + 18p^2 + 54p + 54$
(b) $q^2 - 6q - 40 + 14r - r^2, q^2 - 2qr + r^2 - 16, q^2 - qr + 4r$

6. Solve the following pair of linear equations by replacement method:

- (a) $2x + 3y = 8, 3x + 2y = 7$
(b) $\frac{2}{3}x + 2y = 1, \frac{x}{3} - \frac{y}{3} = 1$
(c) $5x - 2y = 10, 4x - 3y = -6$

7. Solve the following pair of linear equations by elimination method:

- (a) $\frac{x}{6} - y = -6$
 $\frac{3x}{4} - 1 = y$
- (b) $\frac{x + y}{2} = \frac{3x - 5y}{4}$
 $\frac{x - 3y}{2} = \frac{x - 1}{3}$

8. The present age of A is 2 times and 4 years more than the present age of B. The present age of B is $\frac{2}{5}$ times and 2 years more than the present age of A. Find the difference between the present age of A and B.
9. The ratio of the present age of Ram and Harish is 5:7. Before 8 years, the ratio between their age was 7:13, then find their present age.
10. Find a two-digit number where the digit of one's place is three times the digit of the tens place and if 36 is added to that number, the place value of the digits interchanged.
11. Bikash plans to establish a new office. He asks the price of the table and chair in a shop. If the price of three tables and two chairs is Rs. 1900 and the price of two tables and four chairs is Rs 1,800, then calculate the price of one table and four chairs.

12. Simplify:

$$\left(\frac{x^m}{x^n}\right)^{m-p+n} \times \left(\frac{x^n}{x^p}\right)^{n-m+p} \times \left(\frac{x^p}{x^m}\right)^{p-n+m}$$

13. Simplify:

$$\frac{1}{1+x^{p-q}+x^{p-r}} + \frac{1}{1+x^{q-p}+x^{q-r}} + \frac{1}{1+x^{r-p}+x^{r-q}}$$

14. Simplify:

$$\frac{\left(9x^2 - \frac{1}{9y^2}\right)^{3x} \left(3x - \frac{1}{3y}\right)^{3y-3x}}{\left(9y^2 - \frac{1}{9x^2}\right)^{3y} \cdot \left(3y + \frac{1}{3y}\right)^{3x-3y}}$$

15. If, $\frac{1}{ab} + \frac{1}{bc} + \frac{1}{ca} = 0$, prove that:

$$(1+x^a+x^{-b})^{-1} + (1+x^b+x^{-c})^{-1} + (1+x^c+x^{-a})^{-1} = 1$$

Answers

1. (a) $\left(6a + \frac{1}{2}\right)(36a^2 - 3a + \frac{1}{4})$
 (b) $(2x - 5y)(4x^2 + 10xy + 25y^2)$
 (c) $(x + 2)(x + 2)(x + 2)$
 (d) $(x - 3)(x - 3)(x - 3)$
 (e) $(4m^2 + 3mn - 7n^2)(4m^2 - 3mn - 7n^2)$
 (f) $\left(3x^2 - \frac{1}{3y^2}\right)\left(3x^2 - \frac{1}{3y^2}\right)$
 (g) $(4 - 3a)(4 - 3a)(4 - 3a)$
 (h) $(a - 2b)(a + 2b)(a + b)(a - b)$
2. (a) $(x + y + 4)$ (b) $(a + b + 1)$
 (c) $x + 3y - 6$ (d) $\left(\frac{x^2}{y^2} - 1 + \frac{y^2}{x^2}\right)$
3. (a) $a^2(a + 2)(a - 2)^2(a^2 - 9)$
 (b) $x(x^2 + y + 3)(x^2 - y - 11)(x^2 + y - 3)$
 (c) $(x + y + z)(x + y - z)(y + z - x)(z + x - y)$
 (d) $(a + b + c)(a - b)(b - c)(c - a)$
4. $2u^2 + 15uv$
5. (a) $\text{HCF} = (p + 3)^2$ $\text{LCM} = 2(p + 3)^3$
 (b) $\text{HCF} = (q - r + 4)$ $\text{LCM} = q(q - r + 4)(q + r - 10)(q - r - 4)$
6. (a) $x = 1, y = 2$
 (b) $x = 2, y = -1$
 (c) $x = 6, y = 10$
7. (a) $x = 12, y = 8$ 8. 22 years
9. 15 years, 21 years
10. The number of Binya searches = 62
11. Rs. 500, Rs. 200 12. 1 13. 1
14. $\left(\frac{x}{y}\right)^{3(x+y)}$

13.0 Review

Draw a pair of triangles in a sheet of paper. Measure all the sides and angles of these triangles and tabulate them. What types of triangles are formed in terms of sides and angles? How can we differentiate whether these triangles are congruent or similar or not? Discuss within pair and write the conclusion. Present the pair task in news print paper with figure in the classroom.

13.1 Properties of triangles and their verification

Divide the students in proper groups on the basis of class size. Draw a pair of triangles by each set of students, such as: equilateral, isosceles, right angled, and scalene.

Activity 1

Verify experimentally that if any side of a triangle is produced the exterior angle so formed is equal to the sum of the two opposite interior angles.

(I) Paper cutting

Draw a figure in a paper and cut it as shown below. Put the two pieces of opposite interior angles in the exterior angle of a triangle. Then present the relation between the exterior angle and the sum of its opposite interior angles of the triangle in your class.

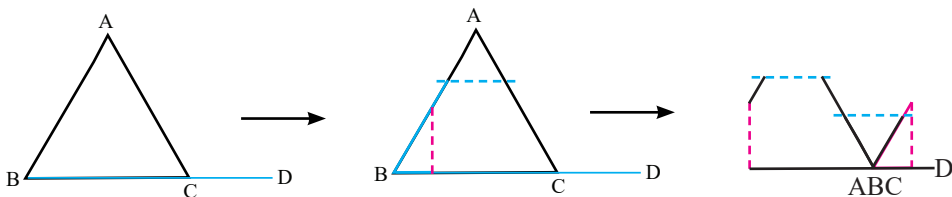

(II) Measuring angles

Draw the figures in your copy as shown below:

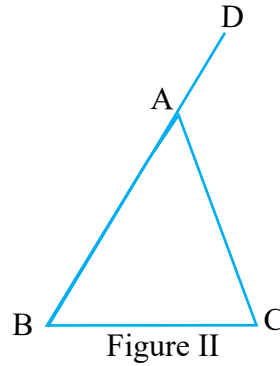
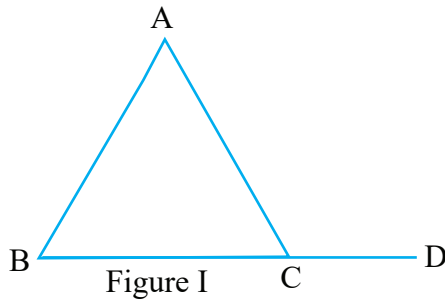

Measure the angles using protractor and tabulate them as shown in the following table.

Figure	Opposite interior angles		Exterior angles	Sum of two opposite interior angles	Results
I.	$\angle ABC =$	$\angle BAC =$	$\angle ACD =$	$\angle ABC + \angle BAC =$	
II.	$\angle ABC =$	$\angle ACB =$	$\angle CAD =$	$\angle ABC + \angle ACB =$	

Present the results in your class based on the above table.

Conclusion: If any side of a triangle is produced, the exterior angle so formed is equal to the sum of the two opposite interior angles.

Example 1

Find the value of x from the following figure:

Solution

Here,

$$x = 50^\circ + 65^\circ$$

$$= 115^\circ$$

$$\therefore x = 115^\circ$$

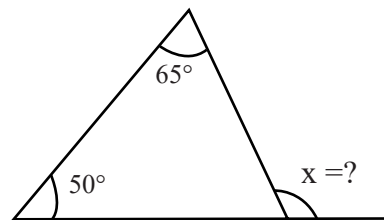

[\because An exterior angle of a triangle is equal to the sum of two opposite interior angles.]

Example 2

Find the value of x from the following figure:

Solution

Here,

From figure, $\angle SPR = (8x + 25)^\circ$

$$\angle PQR = (2x + 10)^\circ \text{ \& } \angle PRQ = (5x + 20)^\circ$$

We know that, $\angle PQR + \angle PRQ = \angle SPR$

$$\text{or, } (2x + 10) + (5x + 20) = (8x + 25)$$

$$\text{or, } 2x + 10 + 5x + 20 = 8x + 25$$

$$\text{or, } 7x + 30 = 8x + 25$$

$$\text{or, } x = 30 - 25 = 5$$

$$\text{Therefore, } \angle SPR = 8x + 25 = 8 \times 5 + 25 = 40 + 25 = 65^\circ$$

$$\text{or, } \angle PQR = 2x + 10 = 2 \times 5 + 10 = 10 + 10 = 20^\circ$$

$$\text{and } \angle PRQ = 5x + 20 = 5 \times 5 + 20 = 25 + 20 = 45^\circ$$

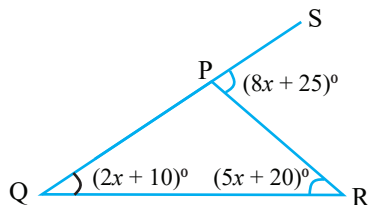

Example 3

The exterior angle of a triangle is 125° and the two opposite interior angles are in the ratio 3:2, then find all interior angles of the triangle.

Solution

Here, exterior angle = 125°

Let us assume that the two non-adjacent interior angles be $3x$ and $2x$.

Now, $3x + 2x = 125^\circ$ [\because An exterior angle of a triangle is equal to the sum of two opposite interior angles.]

$$\text{or, } 5x = 125^\circ$$

$$\text{or, } x = \frac{125^\circ}{5} = 25^\circ$$

Then, the three angles of the triangle are:

$$\text{First angle} = 3x = 3 \times 25^\circ = 75^\circ$$

$$\text{Second angle} = 2x = 2 \times 25^\circ = 50^\circ$$

$$\text{Third angle} = 180^\circ - 125^\circ = 55^\circ$$

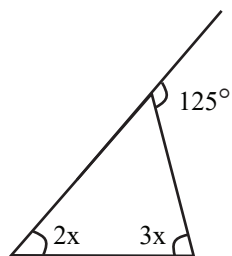

Exercise 13.1

1. Write the reason whether the following statements are true or false.

- (a) There are two right angles in a triangle.
- (b) There are all acute angles in a triangle.
- (c) If the value of an exterior angle of a triangle is 130° , then the adjacent angle is also obtuse angle.
- (d) If interior angle is acute angle, then the adjacent exterior angle is obtuse angle.

2. Find the value of x and y from the following figures:

(a)

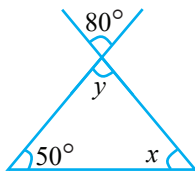

(b)

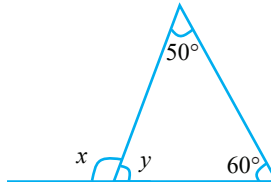

(c)

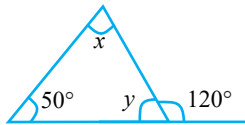

(d)

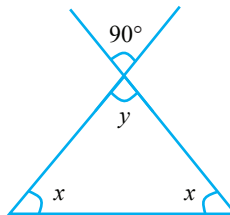

3. Find the value of x , y , z and a from the following figures:

(a)

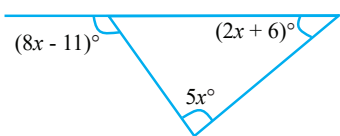

(b)

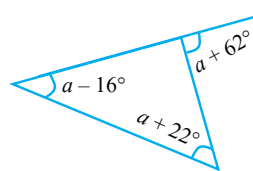

(c)

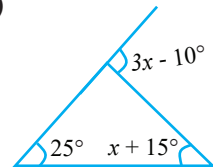

(d)

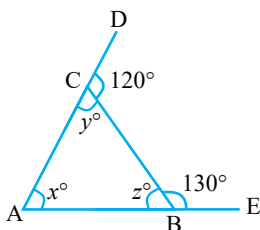

(e)

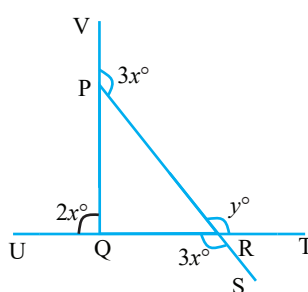

(f)

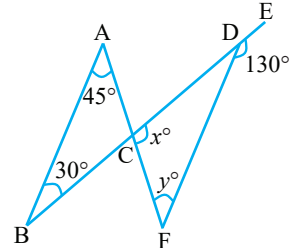

4. The exterior angle of a triangle is 120° and the ratio of two opposite interior angles are 3:2, then find the measurement of all the interior angles of the triangle.
5. What is the measurement value of $\angle ACE$, if $\angle BAC : \angle ABC : \angle ACB = 2:1:1$ and $\angle ABC = \angle ECD$ in the given figure?

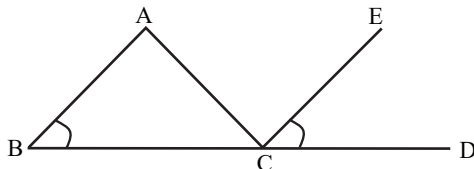

Answer

1. Show the answer to your teacher.
2. (a) $x = 50^\circ, y = 80^\circ$ (b) $x = 110^\circ, y = 70^\circ$ (c) $x = 70^\circ, y = 60^\circ$
 (d) $x = 45^\circ, y = 90^\circ$
3. (a) 17° (b) 56° (c) 25°
 (d) $x = 70^\circ, y = 60^\circ, z = 50^\circ$ (e) $45^\circ, 135^\circ$ (f) $x = 105^\circ, y = 25$
4. $40^\circ, 60^\circ, 80^\circ$ 5. 90°

13.2 Verification of properties of isosceles triangle

Divide the suitable groups and draw a pair of isosceles triangle by each groups. Measure the sides and angles of both isosceles triangles using scale and protractor. Find the relationship of between sides and angles, and draw the conclusion. Discuss in your group and present the conclusion in the class.

Activity 1

- (a) **Verify experimentally that the bisector of vertical angle of an isosceles triangle is perpendicular to the base and bisects it.**

(I) **Folding paper**

Take a rectangular sheet of paper. Fold the paper by overlapping the adjacent sides and make square. Then, fold the square piece of paper diagonally and cut it. It formors an isosceles triangle shown as in the following figure.

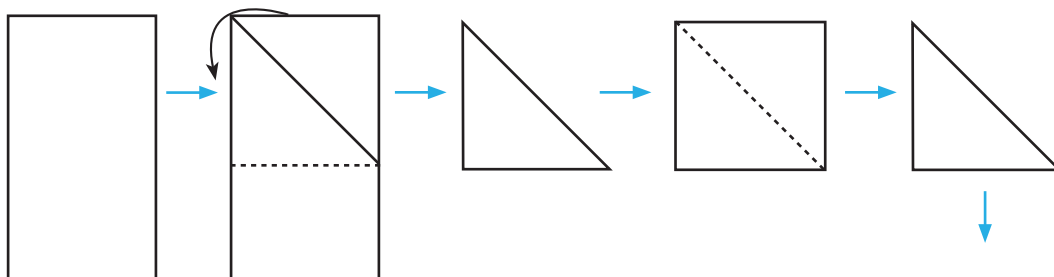

Again, fold the isosceles triangular piece of paper ABC as shown in figure and measure the sides and angles formed.

- (a) BD and CD
(b) $\angle BDA$ and $\angle CDA$

Draw the conclusion and present in the class.

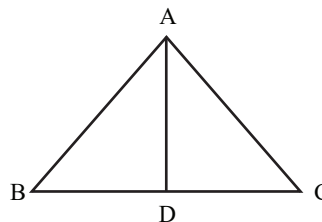

(II) **Measuring sides and angles**

Divide the class in a suitable group. Draw two different size isosceles triangles ABC in each group.

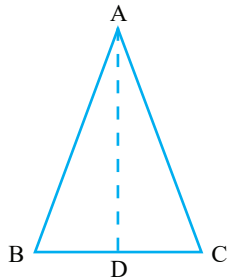

Figure I

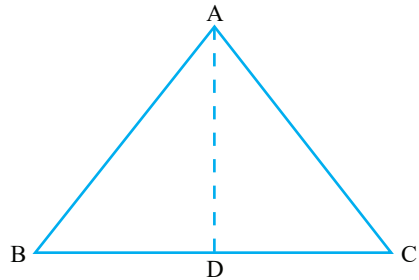

Figure II

Draw angle bisector of vertex A using compass or protractor. The angle bisector AD meets opposite side BC at point D.

Now, measure the angles $\angle ADB$ and $\angle ADC$ and sides BD and CD; and tabulate them as shown in the following table.

Figure	$\angle ADB$	$\angle ADC$	BD	DC	Results
I.					
II.					

Conclusion: The bisector of vertical angle of an isosceles triangle is perpendicular to the base and bisects it.

Activity 2

(b) **Verify experimentally that the perpendicular bisector of base bisects the vertical angle of isosceles triangle.**

Draw two different size isosceles triangles ABC in each group with your friend.

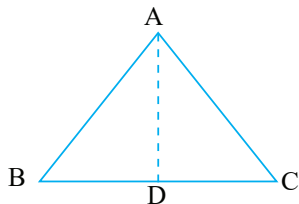

Figure I

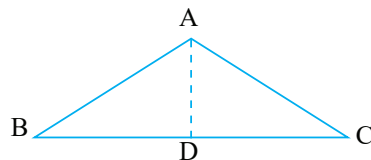

Figure II

Draw perpendicular bisector of base BC using compass. The perpendicular bisector cut at point D of base BC.

Now, measure the angles $\angle BAD$ and $\angle CAD$; and tabulate them as shown in the following table.

Figure	$\angle BAD$	$\angle CAD$	Result
I.			
II.			

Conclusion: Perpendicular bisector of base bisects the vertical angle of isosceles triangle.

Example 1

Find the value of x from the given figure:

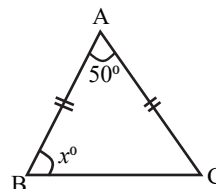

Solution

Here, $\angle BAC = 50^\circ$, $AB = AC$

Since, the base angles of isosceles triangle are equal.

$$\angle ABC = \angle ACB = x$$

$$\angle ABC + \angle ACB + \angle BAC = 180^\circ$$

$\left[\because \text{Sum of interior angle of triangle} \right]$

$$\text{or, } x + x + 50^\circ = 180^\circ$$

$$\text{or, } 2x = 130^\circ$$

$$\text{or, } x = \frac{130^\circ}{2}$$

$$\text{or, } x = 65^\circ$$

Example 2

Find the value of x from the given figure:

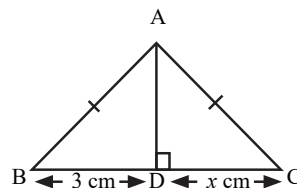

Solution:

Here, $AB = AC$, $AD \perp BC$, $DC = x$ cm, $BD = 3$ cm.

In the isosceles triangle ABC, the perpendicular bisects the base BC into two equal parts.

Thus, $BD = DC$

$$\text{or, } 3 \text{ cm} = x \quad \therefore x = 3 \text{ cm}$$

Example 3

If $PQ = PR$ and $\angle BAR = \angle PRQ$ in the given figure, then find the value of $\angle APQ$.

Solution

Here, $PQ = PR$ and $\angle BAR = \angle PRQ$

$$\therefore \angle PRQ = 63^\circ$$

Now, in isosceles triangle PQR

$$\therefore \angle PRQ = \angle PQR = 63^\circ$$

In $\triangle PQR$, $\angle APQ = \angle PRQ + \angle PQR = 63^\circ + 63^\circ = 126^\circ$

$$\therefore \angle ARQ = 126^\circ$$

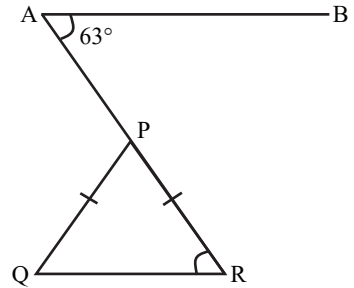

Exercise 13.2

1. Find the value of x from the following figures:

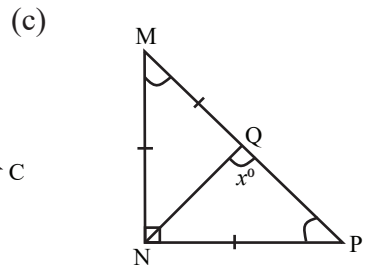
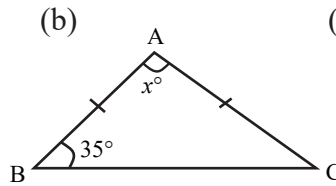
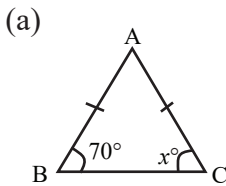

2. Find the value of x° , y° and z° from the given figures:

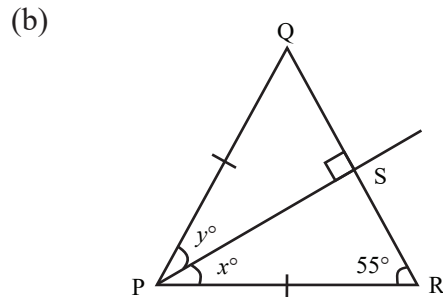
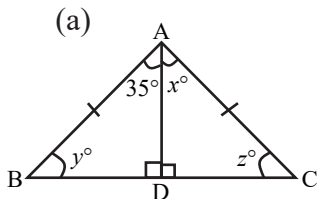

3. Find the value of x and y from the given figures:

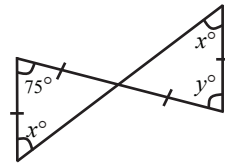
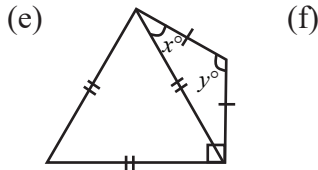
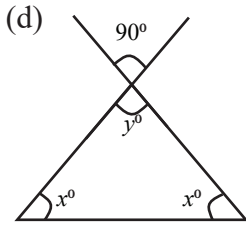
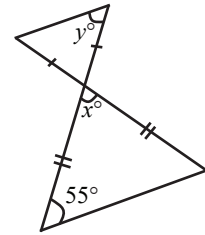
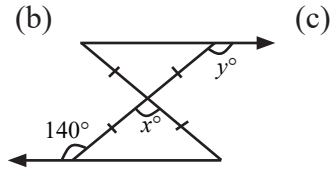
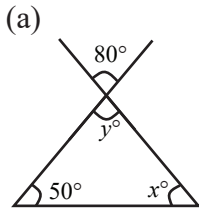

4. In the below figure, if $XY = 3y$, $XZ = 7x$, $XP = 9x$ and $XQ = 13 + 2y$, then find the value of x and y .

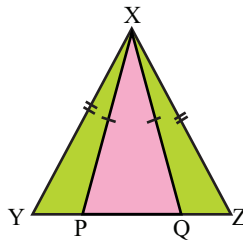

5. If triangle ABC and BCD are isosceles triangle, then find the value of $\angle BDE$ from the below figure.

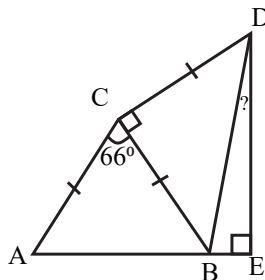

6. Two equal length of wire are tied at the ground from the top of a pole. If the length of the wire is 13m and height of the pole is 12m, then

- (a) Find the distance between the pole and wire in the ground
 (b) Are the area of $\triangle ABC$ and $\triangle ABD$ equal? Justify.

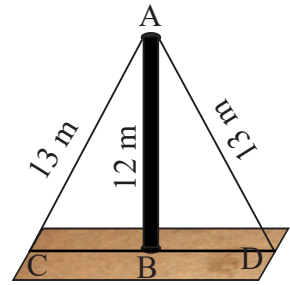

Answer

- | | | |
|---|------------------------------------|-------------------|
| 1. (a) 70° | (b) 110° | (c) 112.5° |
| 2. (a) $x = 35^\circ, y = 55^\circ, z = 55^\circ$ | (b) $x = 35^\circ, y = 35^\circ$ | |
| 3. (a) $x = 50^\circ, y = 80^\circ$ | (b) $x = 100^\circ, y = 140^\circ$ | |
| (c) $x = 70^\circ, y = 55^\circ$ | (d) $x = 45^\circ, 90^\circ$ | |
| (e) $x = 30^\circ, 120^\circ$ | (f) $x = 52.5^\circ, 75^\circ$ | |
| 4. $x = 3, y = 7$ | | |
| 5. 12° | | |
| 6. 5 m | | |

13.3 Relation among sides and angles of triangle

Activity 1

Divide the class in a suitable group. Collect three sticks and connect the ends of each stick to form a triangle by each group.

Are all the figures of each group triangle? If the triangle is formed then what type of triangle is it? If not, why the figure not a triangle? Discuss the results and present the conclusion in the class.

The type of triangle depends on the length of the sides of the triangle.

(a) Relation between the sum of any two sides of a triangle and the third side

Activity 2

Experimentally verify that the sum of any two sides of a triangle is greater than the third side.

- Divide the class into a suitable group.
- Draw a different shape and size triangle by each student.

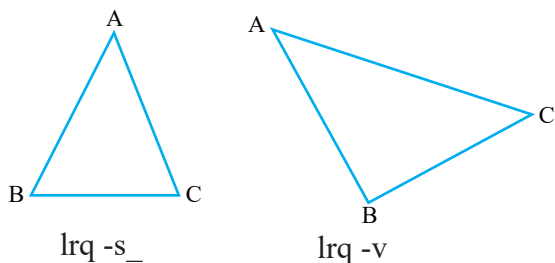

- Measure all the sides of the triangle and tabulate the sum of any two sides as shown in the following table:

Figure	AB	BC	AC	AB + AC	AB + BC	BC + AC	Results
I.							
II.							

- Discuss and draw the conclusion in your group, and write the conclusion.

Conclusion: The sum of any two sides of a triangle is greater than the third side.

If the sum of any two sides of a triangle is equal or less than the third side, then what may be the result?

Relation between the sides and angles of a triangle

Activity 3

Experimentally verify that the angle opposite to the longer side is greater than the angle opposite to the shorter side

(I) Using Machaon Strip

Make a triangle ABC using Mechano strip by each group.

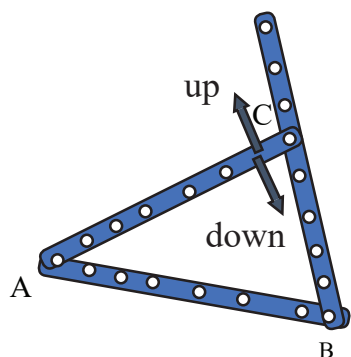

Figure I

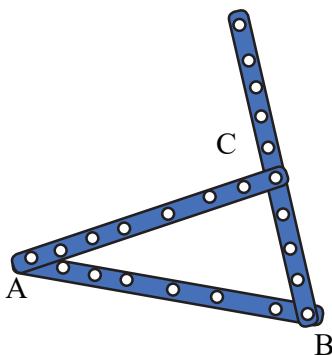

Figure II

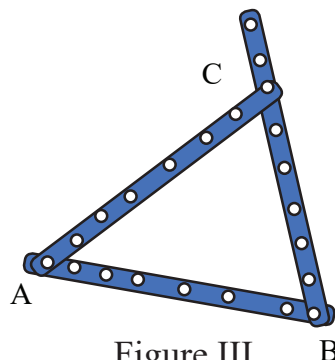

Figure III

Move the point C of the triangle ABC down as shown in the above figure II.

Move the point C of the triangle ABC up as shown in the above figure III.

Measure the $\angle CAB$ and side BC in both cases, and tabulate them as follows:

Figure	AB	AC	BC	$\angle CAB$	Relation of BC and $\angle CAB$	Result
I.						
II.						
III.						

Draw the conclusion from the above table about the relation between an angle and its opposite side.

(II) Measuring sides and angles

Draw the figure of three types of triangles according to the angle (acute, right and obtuse angled triangle).

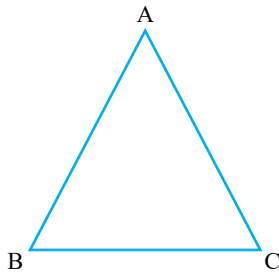

Figure I

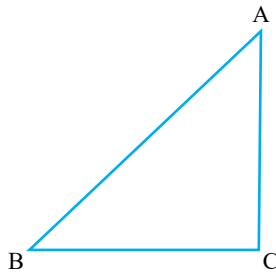

Figure II

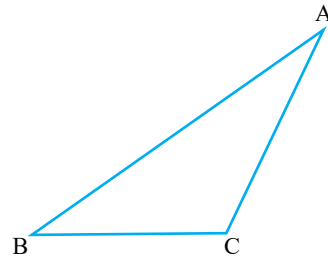

Figure III

Measure all the angles and their opposite sides and tabulate them as follows:

Figure	AB	$\angle ACB$	BC	$\angle BAC$	AC	$\angle ABC$	Result
I.							
II.							
III.							

Conclusion: The angle opposite to the longer side is greater than the angle opposite to the shorter side.

Example 1

In triangle ABC, $\angle BAC = 50^\circ$ and $\angle ABC = 60^\circ$ then find the longest and shortest side of the triangle ABC.

Solution

Here, $\angle BAC = 50^\circ$, $\angle ABC = 60^\circ$

We know that, $\angle BAC + \angle ABC + \angle ACB = 180^\circ$

$$\text{or, } 50^\circ + 60^\circ + \angle ACB = 180^\circ$$

$$\text{or, } 110^\circ + \angle ACB = 180^\circ$$

$$\text{or, } \angle ACB = 180^\circ - 110^\circ$$

$$\text{or, } \angle ACB = 70^\circ$$

$\left[\because \text{Sum of interior angle of triangle.} \right]$

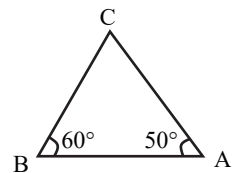

Hence, the longest side is AB and shortest side is BC which are the opposite sides of angles 70° and 50° respectively.

Exercise 13.3

1. Measure all the sides of triangle ABC, and find the largest and smallest angle of the triangle based on the length of the sides.

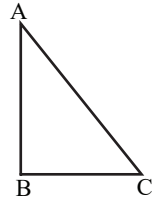

2. Measure all the angles of triangle ABC, and find the longest and shortest sides of the triangle based on the size of the angles.

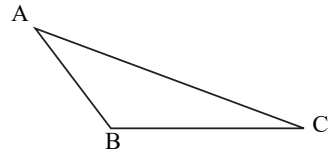

3. The measurements of three sides of a triangle are 5 cm, 6 cm and x . If x is the longest side, then which one is the correct answer among the following options?

(a) 11 cm (b) < 11 cm (c) > 11 cm (d) ≤ 11 cm

4. If $\angle ABC > \angle DBC$, then prove that $AC > BC$ from the given figure.

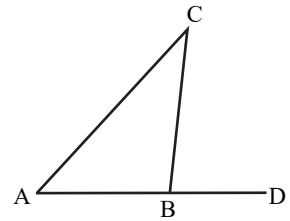

5. Prove that $PQ + QR + RS > SP$ in the given figure.

[Hints: Join points P and R]

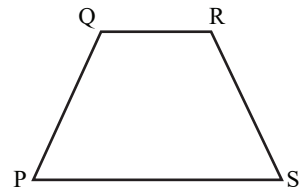

Answer

- 1 - 2. Show to your teacher
 3. (b) < 11
 4. 13 cm
 5 - 6. Show to your teacher

13.4 Similar triangles

Activity 1

Observe the following figures and discuss.

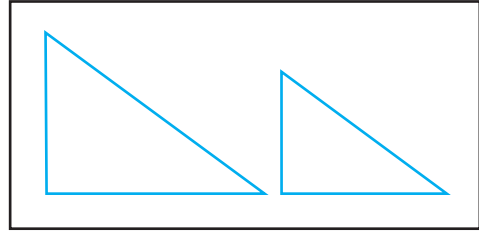
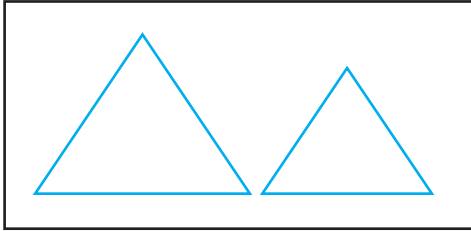

- What types of above pair figures?
- Are the sides of each pair figures equal?
- Similarly, are the angles of each pair figures equal?

The given pair figures are same shape but not same size. Such types of figures are called similar figures.

The geometrical figure which are in same shape are called the similar figures.

In similar triangles, equal angles are said to be corresponding angles and opposite sides of equal angles are said to be corresponding sides.

Given triangles ABC and DEF are similar, and angles A , B and C are equal with D , E and F respectively. Then the angles A , B and C are corresponding angles with D , E and F respectively. Similarly, the sides AB , BC and AC are corresponding sides of DE , EF and DF respectively.

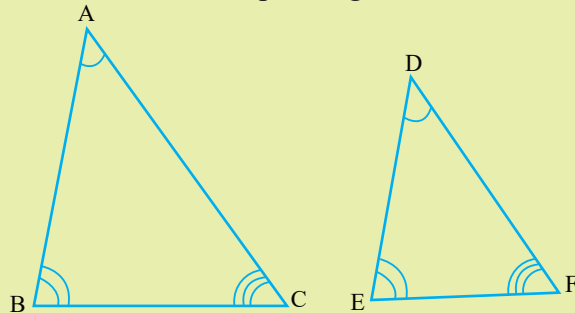

Activity 2

Draw two triangles in a cardboard as shown in the figure.

Cut the cardboard to make triangle with a help of scissor.

Overlap the corresponding vertices of these two triangles and observe. If all the vertices are completely overlapped, then we can say that the corresponding angles are equal. Thus, the two triangles are similar.

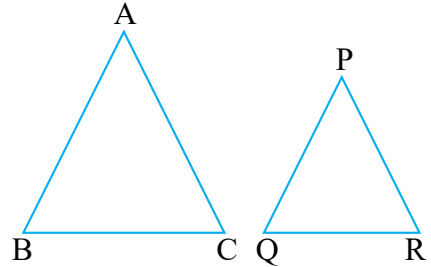

All three angles of a triangle are equal with all the three angles of another triangle, then the two triangles are similar. In the given triangles ABC and PQR, $\angle A$ and $\angle P$, $\angle B$ and $\angle Q$, $\angle C$ and $\angle R$ are corresponding angles.

If corresponding angles of two triangles are equal, then the triangles are similar.

Relation of corresponding angles of similar triangles

Activity 3

Take a triangle ABC. Draw a parallel line EF with BC using set square.

There are two triangles ABC and AEF. Are the triangles ABC and AEF similar? Measure the sides AB, BC and AC of triangle ABC, and the sides AE, EF and AF of triangle AEF.

And then, find the value of ratio:

$\frac{AE}{AB}$, $\frac{EF}{BC}$, $\frac{AF}{AC}$ and the relation of sides; and discuss in class.

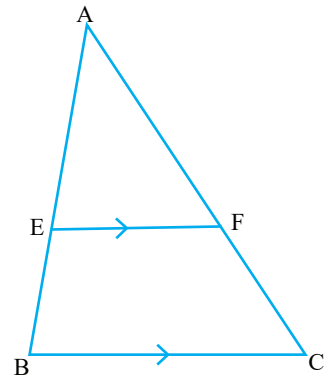

If two triangles are similar to each other, then the ratio of corresponding sides are equal.

In the above figure $\frac{AE}{AB} = \frac{EF}{BC} = \frac{AF}{AC}$. It can also be written as $\frac{AB}{AE} = \frac{BC}{EF} = \frac{AC}{AF}$.

Theorem 1

Line drawn parallel to the any side of a triangle cuts the remaining two sides in the same ratio.

Here,

Given: Line XY is drawn parallel to the base BC of a triangle ABC and meets the points E and F of sides AB and AC respectively.

To prove: $\frac{AE}{EB} = \frac{AF}{FC}$

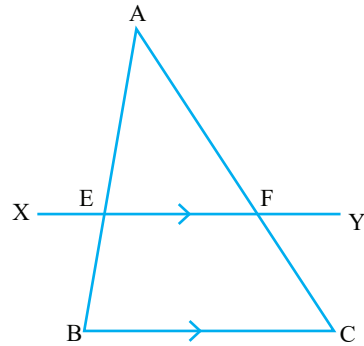

Proof:

	Fact		Reason
1.	$\triangle ABC$ and $\triangle AEF$	1.	
(i)	$\angle ABC = \angle AEF$ (A)	(i)	Corresponding angles ($XY \parallel BC$)
(ii)	$\angle ACB = \angle AFE$ (A)	(ii)	Corresponding angles ($XY \parallel BC$)
(iii)	$\angle BAC = \angle EAF$ (A)	(iii)	Common angle
2.	$\triangle ABC \sim \triangle AEF$	2.	All the corresponding angles of two triangles are equal to each other
3.	$\frac{AB}{AE} = \frac{AC}{AF}$ $\text{or, } \frac{AE + EB}{AE} = \frac{AF + FC}{AF}$ $\text{or, } \frac{AE}{AE} + \frac{EB}{AE} = \frac{AF}{AF} + \frac{FC}{AF}$ $\text{or, } 1 + \frac{EB}{AE} = 1 + \frac{FC}{AF}$ $\text{or, } \frac{EB}{AE} = \frac{FC}{AF}$ $\text{or, } \frac{AE}{EB} = \frac{AF}{FC}$	3.	The ratio of corresponding sides of similar triangles

Proved

Example 1

Given triangles, PQR and PST are similar. If PQ = 8 cm, PR = 6 cm and PT = 4 cm, then

- Find the length of side PS.
- If ST = 6 cm, then find the length of side QR.

Solution

Here, the triangles PQR and PST are similar.

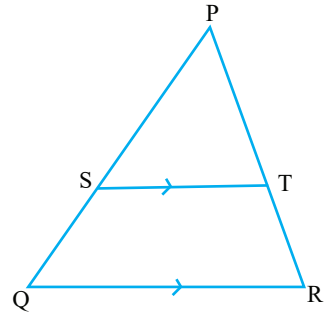

Thus,

$$\frac{PQ}{PS} = \frac{PR}{PT} = \frac{QR}{ST}$$

$$\text{or, } \frac{8 \text{ cm}}{PS} = \frac{6 \text{ cm}}{4 \text{ cm}} = \frac{QR}{6 \text{ cm}}$$

- From first and second ratio

$$\frac{8 \text{ cm}}{PS} = \frac{6 \text{ cm}}{4 \text{ cm}}$$

$$\text{or, } PS = \frac{8 \text{ cm} \times 4 \text{ cm}}{6 \text{ cm}} = 5.34 \text{ cm}$$

- From second and third ratio

$$\frac{6 \text{ cm}}{4 \text{ cm}} = \frac{QR}{6 \text{ cm}}$$

$$\text{or, } QR = \frac{6 \text{ cm} \times 6 \text{ cm}}{4 \text{ cm}} = 9 \text{ cm}$$

Example 2

In the given figure $XY \parallel QR$, the ratio of PX and XQ is $5:4$ and $PR = 7.2$ cm, then what is the value of PY ?

Solution

From the figure, $XY \parallel QR$, $PX : XQ = 5 : 4$ and $PR = 7.2$ cm

Then $PY = ?$

Let, $PY = x$

Thus, $YR = 7.2$ cm $- x$ cm

We know that, $\frac{PX}{XQ} = \frac{PY}{YR}$

$$\text{or, } \frac{5}{4} = \frac{x}{7.2 - x}$$

$$\text{or, } 36 - 5x = 4x$$

$$\text{or, } 9x = 36$$

$$\therefore x = PY = 4 \text{ cm}$$

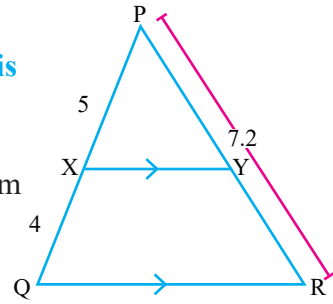

Alternative method

$$\frac{PX}{PQ} = \frac{PY}{PR}$$

$$\text{or, } \frac{5}{9} = \frac{PY}{7.2}$$

$$\text{or, } 9PY = 36$$

$$\text{or, } 9PY = 36$$

$$\text{or, } PY = 4 \text{ cm}$$

[ΔPXY and ΔPQR are similar triangles]

Example 3

The height of Dipika is 1.2 meter. She stands in front of the light pole of 3.9 m height. If the length of the shadow of the pole is 6.5 m, then find the length of shadow of Dipika at that time.

Solution

Let AB be a height of pole, CD be the height of Dipika

BE be the length of shadow of pole and DE be the length of the shadow of Dipika.

Then, $AB = 3.9$ m, $BE = 6.5$ m, $CD = 1.2$ m, $ED = ?$

ΔCDE and ΔABE are similar.

[\because Both right angled triangle and $\angle E$ is common]

$$\text{or, } \frac{AB}{CD} = \frac{BE}{DE}$$

[\because Ratio of corresponding angles of similar triangles]

$$\text{or, } \frac{3.9}{1.2} = \frac{6.5}{DE}$$

$$\text{or, } 3.9 DE = 6.5 \times 1.2$$

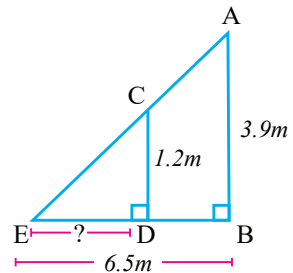

$$\text{or, } DE = \frac{6.5 \times 1.2}{3.9} = 2 \text{ m}$$

Hence, the length of the shadow of Dipika is 2 meter.

Exercise 13.4

- In triangle $BC \parallel DE$, $AD: BD = 2: 3$ and $EC = 12 \text{ cm}$, then what is the value of AE ?
- In triangle XYZ , if $YZ \parallel PQ$, $XQ: QZ = 3.5$ and $PY = 7.5 \text{ cm}$, then find the value of XY .

- Find the value of x from the given figure:

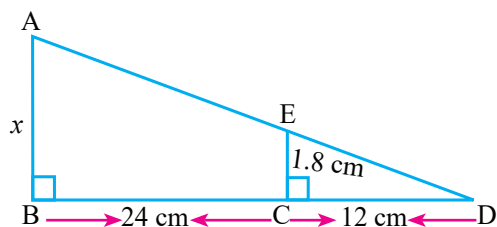

- The angles made by two ladders are the same in the given figure. Find the length of the smaller ladder.

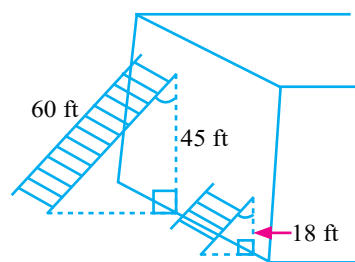

- (a) Find the height of tree from the adjoining figure?

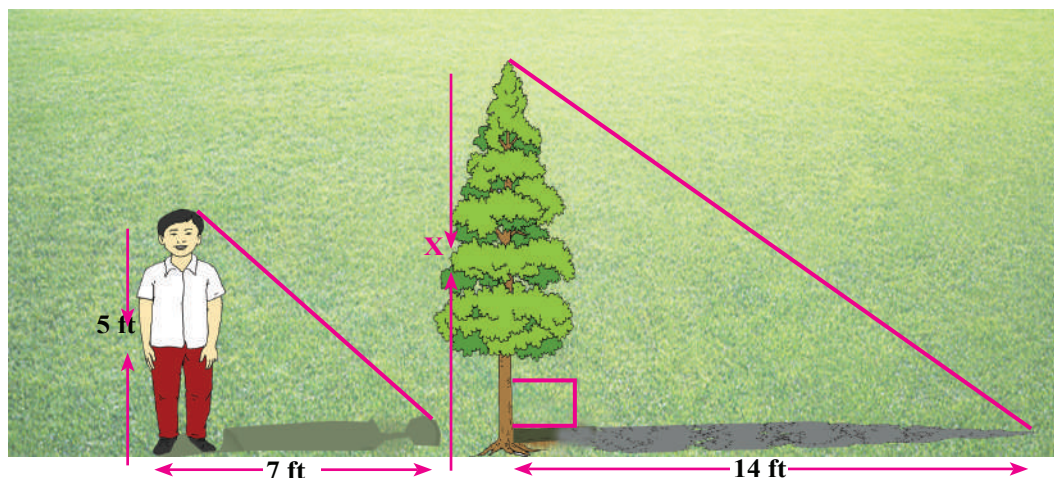

- b) If the length of the shadow of a pole of height 20 m is 30m, then what is the height of the another pole whose length of shadow is 7.5 m.

6. Angel put a mirror on the ground in between him and a tree of his school ground. He moves here and there until he saw the whole tree. At this time, how can we find the height of the tree discussing your friends?

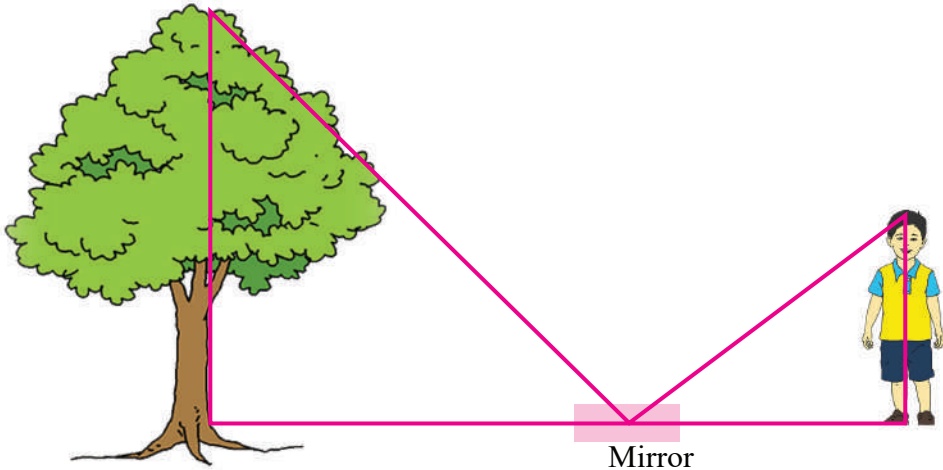

Project work

Divide all the students in a suitable group. Stand on the playground and take the height and length of your shadow with the help of your friends. At the same time, measure the length of the shadow of a pole standing on the playground. Find the height of the pole from this information and present the result in your class.

Answer

1. 8 cm
2. 12 cm
3. 5.4 cm
4. 24 ft
5. (a) 10 ft
- (b) 5 m
6. Show to your teacher

14.0 Review

Activity 1

- Divide the students in a appropriate group.
- Prepare a parallelogram using Metacard in each group.
- Cut the parallelogram in the middle part as shown in the figure below.

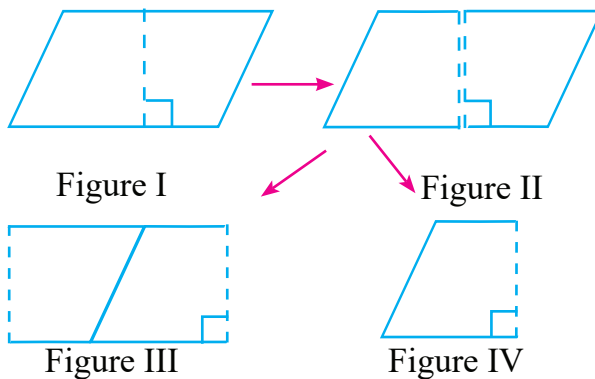

- Join the two pieces of parallelogram as shown in Figure III. What type of figure is made? Discuss and draw the conclusion about the sides and angles.
- Again, overlap the two pieces of Figure II as shown in Figure IV. What is the relation of angles between the Figure I and Figure IV? Draw the conclusion in your group.

14.1 Verification of properties of parallelogram

Activity 2

Hang the figures in your classroom wall in different places as given below. Observe the figures by each student in the bench one by one. Draw the conclusion; and write the conclusion in your copy based on the name, sides, and angles. Discuss in your bench, write the properties of each figure with separate figure, and present in your class.

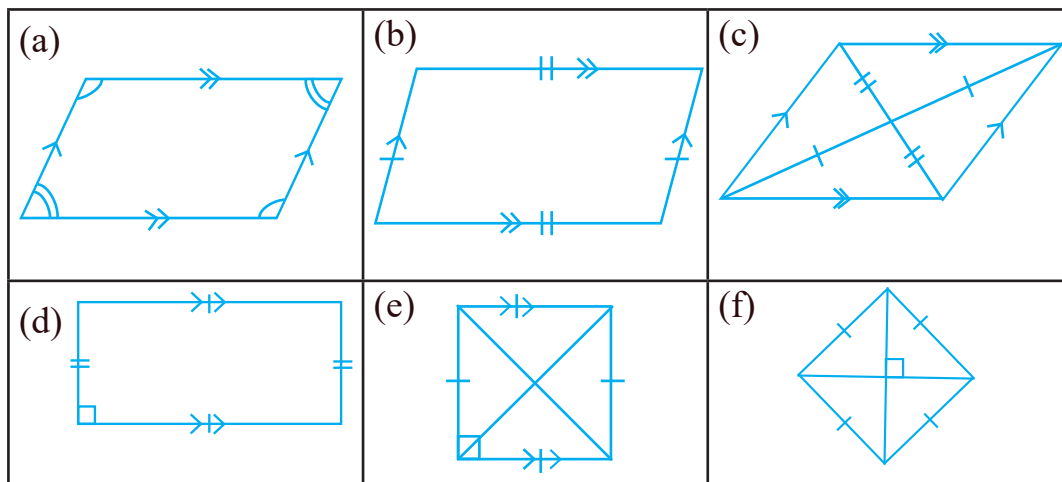

Theorem 1

The line segments joining the ends towards same side of two equal and parallel line segments are also equal and parallel to each other.

Given: Two line segments $AB = CD$ and $AB \parallel CD$.

Points A and C, with B and D are joining.

To prove, $AC = BD$ and $AC \parallel BD$

Construction: Join points B and C

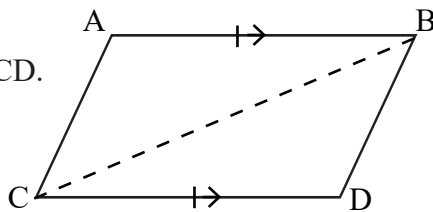

Proof:

	Statements		Reasons
1.	In $\triangle ABC$ and $\triangle BCD$	1.	
(i)	$AB = CD$ (S)	(i)	Given
(ii)	$\angle ABC = \angle BCD$ (A)	(ii)	Alternate angles $AB \parallel CD$
(iii)	$BC = BC$ (S)	(iii)	Common side
2.	$\triangle ABC \cong \triangle BCD$	2.	SAS axiom
3.	$AC = BD$	3.	Corresponding sides of congruent triangles
4.	$\angle ACB = \angle CBD$	4.	Corresponding angles of congruent triangles are equal
5.	$AC \parallel BD$	5.	Alternate angles
6.	$AC = BD$ and $AC \parallel BD$	6.	From statements 3 and 6

Proved that

Theorem 2

The line joining the opposite ends of two equal and parallel line segments bisect each other.

Given: Line segments $PQ = RS$, $PQ \parallel RS$ in which opposite ends P and S , and Q and R are joined. Line segments PS and QR intersect at point O .

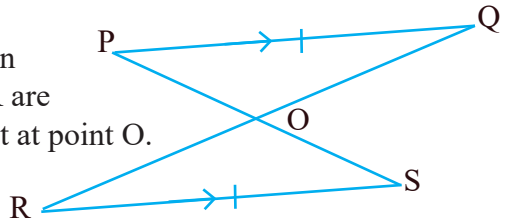

To prove: $PO = OS$ and $QO = OR$ or PS and QR are bisect each other.

Proof:

S. No.	Statements	S. No.	Reasons
1.	In $\triangle POQ$ and $\triangle ROS$	1.	
(i)	$\angle OPQ = \angle OSR$ (A)	(i)	Alternate angles $PQ \parallel RS$
(ii)	$PQ = RS$ (S)	(ii)	Given
(iii)	$\angle PQO = \angle SRO$ (A)	(iii)	Alternate angles $PQ \parallel RS$
2.	$\triangle POQ \cong \triangle ROS$	2.	ASA axiom
3.	$PO = OS, QO = OR$	3.	Corresponding sides of congruent triangles

Proved

Theorem 3

The opposite sides and angles of a parallelogram are equal.

Given: $ABCD$ is a parallelogram in which $AB \parallel DC$ and $AD \parallel BC$.

To prove:

- $AB = DC, AD = BC$
- $\angle ABC = \angle ADC, \angle DAB = \angle BCD$

Construction: Join the points B and D .

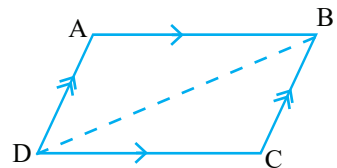

Proof

S. No.	Statements	S. No.	Reasons
1.	In $\triangle ABD$ and $\triangle BCD$	1.	
(i)	$\angle ABD = \angle BDC$ (A)	(i)	AB//DC Alternate angles
(ii)	BD = BD (S)	(ii)	Common sides
(iii)	$\angle ADB = \angle DBC$ (A)	(iii)	AD//BC Alternate angles
2.	$\triangle ABD \cong \triangle BCD$	2.	ASA axiom
3.	AB = DC and AD = BC	3.	Corresponding sides of congruent triangles
4.	$\angle DAB = \angle BCD$ $\angle ABD = \angle BDC$ $\angle ADB = \angle DBC$	4.	Corresponding angles of congruent triangles
5.	$\angle ABD + \angle DBC =$ $\angle BDC + \angle ADB$	5.	Equal axiom
6.	$\angle ABC = \angle ADC$	6.	From statement 5
7.	AB = DC, AD = BC and $\angle ABC = \angle ADC$, $\angle DAB =$ $\angle BCD$	7.	From statements 3, 4 and 6

Proved

Theorem 4

The quadrilateral having opposite sides equal is a parallelogram.

Given: In quadrilateral ABCD, AB = CD and AD = BC.

To prove: ABCD is a parallelogram.

That is, AB//CD and AD//BC

Construction: Join the points A and C

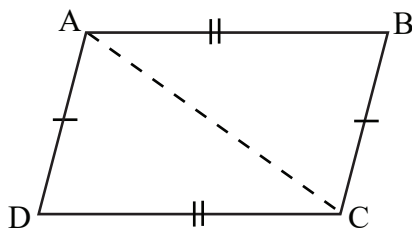

Proof:

S. No.	Statements	S. No.	Reasons
1.	In $\triangle ABC$ and $\triangle ACD$	1.	
(i)	$AB = CD$ (S)	(i)	Given
(ii)	$AD = BC$ (S)	(ii)	Given
(iii)	$AC = AC$ (S)	(iii)	Given
2.	$\triangle ABC \cong \triangle ACD$	2.	SSS axiom
3.	$\angle ACB = \angle DAC$ $\angle BAC = \angle ACD$	3.	Corresponding angles of congruent triangles
4.	$AB \parallel CD, AD \parallel BC$	4.	Being equal alternate angles

Proved

Theorem 5

The quadrilateral having opposite angles equal is a parallelogram.

Given: In quadrilateral ABCD $\angle ABC = \angle ADC$ and $\angle DAB = \angle BCD$

To prove: ABCD is a parallelogram.

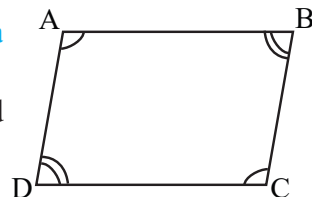

Proof:

S. No.	Statements	S. No.	Reasons
1.	$\angle ABC + \angle BCD + \angle CDA + \angle DAB = 360^\circ$	1.	The sum of interior angles of quadrilateral
2.	$\angle ABC + \angle BCD + \angle ABC + \angle BCD = 360^\circ$ or, $2\angle ABC + 2\angle BCD = 360^\circ$ or, $\angle ABC + \angle BCD = 180^\circ$	2.	Being $\angle ABC = \angle CDA$ and $\angle DAB = \angle BCD$
3.	$AB \parallel CD$	3.	Being sum of co-interior angles
4.	Similarly $\angle BCD + \angle CDA = 180^\circ$	4.	Reasons like: 1, 2, 3
5.	$BC \parallel AD$	5.	Being sum of co-interior angles
6.	$AB \parallel CD, BC \parallel AD$	6.	From statements 3 and 5
7.	ABCD is a parallelogram	7.	From statement 6

Proved

Theorem 6

The diagonals of a parallelogram bisect to each other.

Given: PQRS is a parallelogram in which the diagonals PR and QS bisect in O.

To prove: $PO = OR$ and $SO = OQ$

Proof:

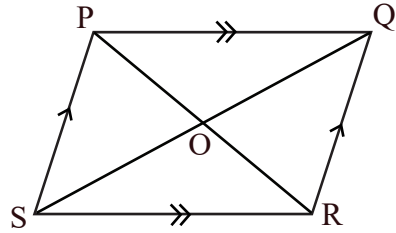

S. No.	Statements	S. No.	Reasons
1.	In $\triangle POQ$ and $\triangle ROS$	1.	
(i)	$\angle OPQ = \angle ORS$ (A)	(i)	Alternate angles $PQ \parallel SR$
(ii)	$PQ = RS$ (S)	(ii)	Opposite sides of parallelogram
(iii)	$\angle OQP = \angle OSR$ (A)	(iii)	Alternate angles $PQ \parallel SR$
2.	$\triangle POQ \cong \triangle ROS$	2.	ASA axiom
3.	$PO = OR, QO = OS$	3.	Corresponding sides of congruent triangles

Proved

Theorem 7 (Converse of Theorem 6)

If the diagonals of a quadrilateral bisect each other, the quadrilateral is a parallelogram.

Given: In quadrilateral ABCD, $AO = OC$ and $DO = OB$

To prove: ABCD is a parallelogram.

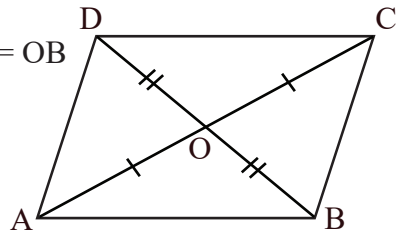

Proof:

S. No.	Statements	S. No.	Reasons
1.	In $\triangle AOB$ and $\triangle DOC$	1.	
(i)	$AO = OC$ (S)	(i)	Given
(ii)	$\angle AOB = \angle COD$ (A)	(ii)	Vertically opposite angles
(iii)	$OB = OD$ (S)	(iii)	Given
2.	$\triangle AOB \cong \triangle DOC$	2.	SAS axiom
3.	$AB = DC$	3.	Corresponding sides of congruent triangles
4.	$\angle OBA = \angle ODC$	4.	Corresponding angles of congruent triangles
5.	$AB \parallel DC$	5.	Alternate angles
6.	$AD \parallel BC, AD = BC$	6.	$AB \parallel DC$ and $AB = DC$
7.	ABCD is a parallelogram	7.	Opposite sides are equal and parallel

Proved

Example 1

Find the value of x and y from the given figure:

Solution

We have,

$$(i) \angle BAE + \angle EDC = 180^\circ$$

$$[\because AB \parallel CD \text{ Co-interior angles}]$$

$$\text{or, } \angle EDC = 180^\circ - \angle BAE = 180^\circ - 116^\circ = 64^\circ$$

$$\angle DCE = \angle DEC = y \quad [\because DE = DC]$$

$$(ii) \angle DEC + \angle ECD + \angle EDC = 180^\circ \quad [\because \text{Interior angles of } \triangle CDE]$$

$$\text{or, } y + \angle ECD + 64^\circ = 180^\circ$$

$$\text{or, } y + y = 180^\circ - 64^\circ \quad [\because CD = DE]$$

$$\text{or, } 2y = 116^\circ$$

$$y = 58^\circ$$

$$\angle BCD = \angle BAD \quad [\because \text{Opposite angles } \square ABCD]$$

$$\text{Again, } x + y = 116^\circ$$

$$\text{or, } x = 116^\circ - y = 116^\circ - 58^\circ = 58^\circ$$

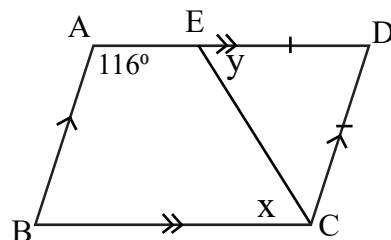

Example 2

From the given rhombus PQRS, find the value of angle PSR:

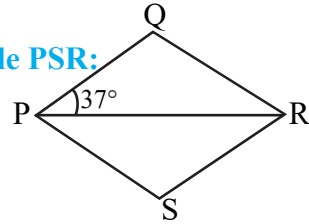

Solution

Here $\angle QPR = \angle QRP = 37^\circ$

[\because In rhombus PQRS, $PR = RQ$]

$\angle QPR + \angle QRP + \angle PQR = 180^\circ$ [\because Interior angles of a triangle PQR]

or, $37^\circ + 37^\circ + \angle PQR = 180^\circ$

or, $\angle PQR = 180^\circ - 74^\circ = 106^\circ$

Again, $\angle PSR = \angle PQR = 106^\circ$ [\because Opposite angles of rhombus]

Thus, $\angle PSR = 106^\circ$

Exercise 14

1. What may be the value of x and y for being the parallelogram of each of the following:

(a) A parallelogram with side lengths $2x$ and x .	(b) A parallelogram with side lengths x and y , and an angle of 118° .	(c) A parallelogram with angles $(y-10)^\circ$, $(5x-10)^\circ$, and $(12x-14)^\circ$.
(d) A parallelogram with diagonal lengths $3x+5$ and $8x$.	(e) A parallelogram with diagonal lengths $3x-11$ and $x+5$.	(f) A parallelogram with diagonal lengths $2x-1$ and $x+5$.

2. Find the value of x and y from the given figure:

(a) A parallelogram ABCD with angle A = 120° and angle C = x .	(b) A parallelogram ABCD with angle A = 54° , angle E = 68° , and angles y and x .
--	---

3. **ABCD is a rhombus. If $\angle DAC = 34^\circ$, then find the value of $\angle DAB$, $\angle ABC$, $\angle BCA$ and $\angle CDA$.**

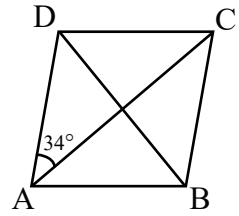

4. If opposite angles of a parallelogram are $(63 - 3x)^\circ$ and $(4x - 7)^\circ$ then find the value of all angles of the parallelogram.

5. **In the given parallelogram MNOP, $MN = OP$ and $PM = ON$ then prove that MNOP is a parallelogram.**

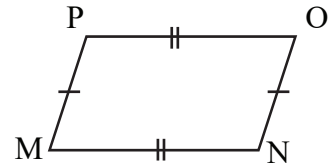

6. **PQRS is a parallelogram. Points X and Y are the midpoint of Sides PQ and RS then prove that PXYR is a parallelogram.**

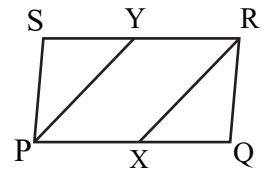

7. **In the given figure $AD = EF$, $AD \parallel EF$, $EF = BC$, $EF \parallel BC$ and
Then prove that ABCD is a parallelogram.**

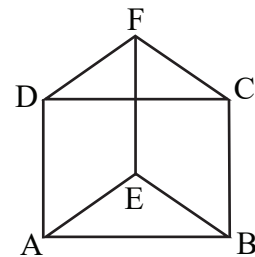

8. In a quadrilateral SLOW, $SL = LO = OW = SW$ then prove that the quadrilateral SLOW is a parallelogram.
9. MOAT is a quadrilateral in which diagonals MA and OT intersect at point R and $MR = RA$ with $TR = OR$. Then prove that quadrilateral MOAT is a parallelogram.

Project work

Divide the students in a suitable group. Go to your school play ground and make a parallelogram and diagonals with a help of rope by each group. Observe the parallelogram and measure the opposite sides and diagonals. Find the relation of opposite sides and parts of diagonals, and present the result in your class.

Answer

1. (a) 60° (b) $x = 56^\circ, y = 62^\circ$ (c) $x = 12^\circ, y = 140^\circ$
(d) $x = 1$ (e) $x = 8$ (f) $x = 6$ 2. (g) 60
(h) $58^\circ, 54^\circ$ 3. $112^\circ, 112^\circ, 68^\circ, 68^\circ$
4. 33° and 147° 5-9. Show to your teacher

15.0 Review

Divide the students having 6/6 students in each group. Name each student: 1, 2, 3, 4, 5, and 6 of each group. Take the specified quadrilateral as naming 1, 2, 3, 4, 5, and 6 by each students from the teacher as shown in the following figure.

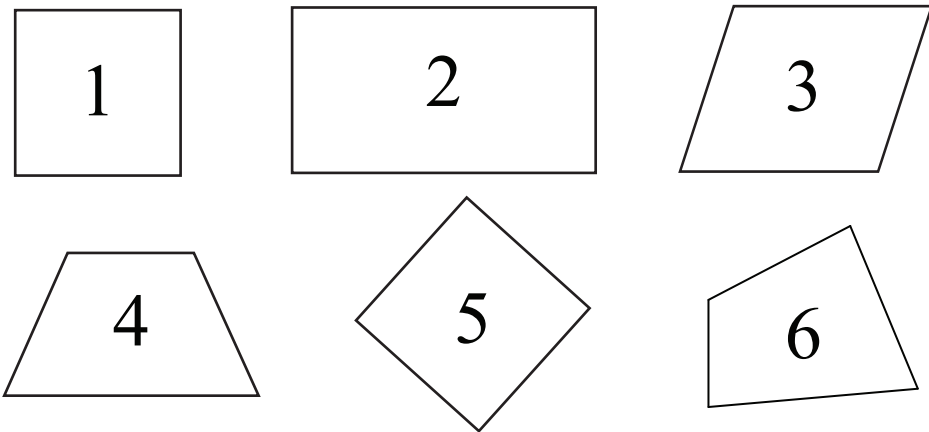

Now, divide the whole students in 6 new groups having the same number, i.e 1/1, 2/2, 3/3, and so on will sit in the new group. Study the quadrilateral of your own group and answer the following questions.

- a) What is the name of your group quadrilateral?
- b) What are the properties of the quadrilateral?

Discuss and draw the common conclusion in new your group.

After drawing the conclusion in your new group, present the result in of all 6 types of quadrilaterets your own old group one. Finally, discuss about the result in the class.

15.1 Construction of scalene quadrilateral

(a) When the measure of four sides and a diagonal are given

Construct a quadrilateral ABCD having $AB = 4.8$ cm, $BC = 4.3$ cm, $CD = 3.6$ cm, $AD = 4.2$ cm and diagonal $AC = 6$ cm.

Solution

At first, draw a rough figure of quadrilateral ABCD.

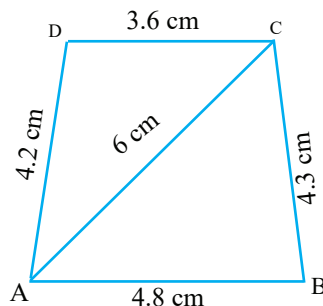

Steps

1. Draw straight line $AB = 4.8$ cm.
2. Cut from point A with an arc 6 cm
3. Cut from point B with an arc 4.3 cm and name the intersecting point C.
4. Join points B and C, and A and C.
5. Again, cut from point A with an arc 4.2 cm.
6. Cut from point C with an arc 3.6 cm and name the intersecting point D.
7. Join points A and D, and then C and D.

Then the required quadrilateral ABCD is constructed.

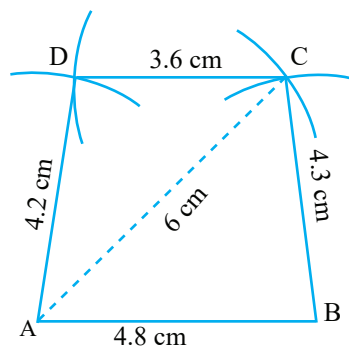

(b) When two adjacent sides and three angles are given

Construct a quadrilateral PQRS of measurement $PQ = 4.5$ cm, $\angle PQR = 120^\circ$, $QR = 3.8$ cm, $\angle QRS = 105^\circ$ and $\angle QPS = 60^\circ$

Solution

First of all, draw a rough figure of quadrilateral PQRS on the basis of given information.

Steps

1. Draw line segment $QR = 3.8$ cm.
2. Draw an angle $\angle RQX = 120^\circ$ at point Q using compass.
3. Cut from point Q with an arc 4.5 cm at point P.
4. Draw an angle of $\angle QRY = 105^\circ$ at point R.
5. Again, draw an angle of $\angle QPZ = 60^\circ$ at point P in which line RY and PZ intersect at point S.

Then the required quadrilateral is PQRS.

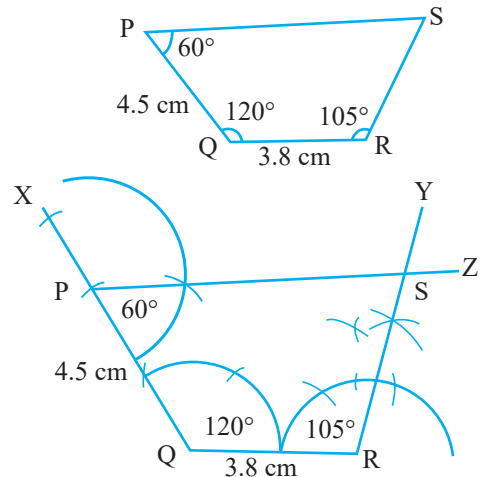

(c) When three sides and two angles are given

Construct a quadrilateral PQRS having $QR = 6$ cm, $RS = 5$ cm, $PS = 5.7$ cm, $\angle S = 105^\circ$, $\angle R = 120^\circ$

Solution

At first, draw a rough figure of quadrilateral PQRS based on the given information.

Steps

1. Draw line segment $RS = 5$ cm.
2. Draw two angles of 120° and 105° at points R and S respectively.
3. Cut from point R with an arc 6 cm at point Q.
4. Cut from point S with an arc 5.7 cm at point P.
5. Now, join points P and Q.
Then the required quadrilateral is PQRS.

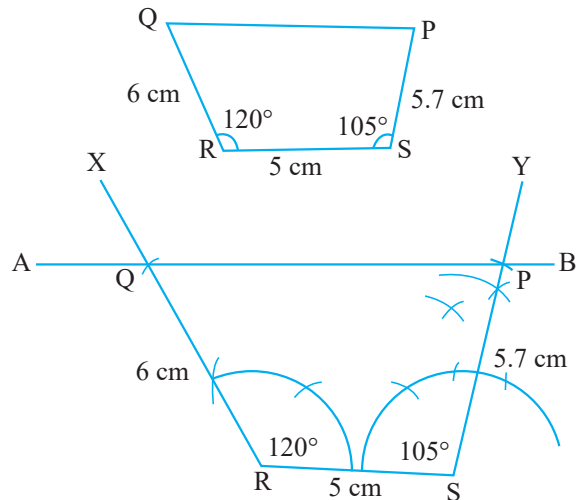

Exercise 15.1

Construct quadrilaterals from the following information.

1. Construct quadrilateral ABCD having $AB = AD = 3$ cm, $BC = 2.5$, $AC = 4$ cm and $BD = 5$ cm.
2. Construct a quadrilateral MNOP having $MO = MP = 6$ cm, $NO = 7.5$ cm, $OP = 5$ cm and $NP = 10$ cm
3. Construct a quadrilateral PQRS having $PQ = 3.5$ cm, $QR = 2.5$ cm, $RS = 4$ cm, $\angle Q = 75^\circ$ and $\angle R = 120^\circ$
4. Construct quadrilateral ABCD having $AB = 3.6$ cm, $BC = 3.3$ cm, $AD = 2.7$ cm diagonals $AC = 4.6$ cm $BD = 4$ cm
5. Construct a quadrilateral PQRS having $PQ = 5$ cm, $QR = 6.5$ cm, $\angle P = \angle R = 100^\circ$ and $\angle S = 75^\circ$
6. Construct a quadrilateral ABCD having $AB = 3.8$ cm, $BC = 3.4$ cm, $CD = 4.5$ cm, $AD = 5$ cm and $\angle B = 60^\circ$

Answer

Show the construction to your teacher.

15.2 Construction of trapezium

(a) When length of three sides and measurement of an angle are given

Construct a trapezium ABCD having $AB \parallel CD$, $AB = 8$ cm, $BC = 6$ cm, $CD = 4$ cm and $\angle ABC = 60^\circ$

Solution

At first, draw a rough figure of trapezium ABCD based on the given information.

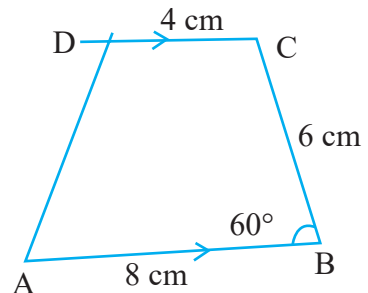

Steps

1. Draw a line segment AB of length.
2. Draw an angle $ABX = 60^\circ$ and cut from point B with an arc 6 cm.
3. Again, draw an angle $BCY = 120^\circ$ at point C using compass.
4. Cut with an arc $CD = 4$ cm from point C.
5. Now, join points A and D.

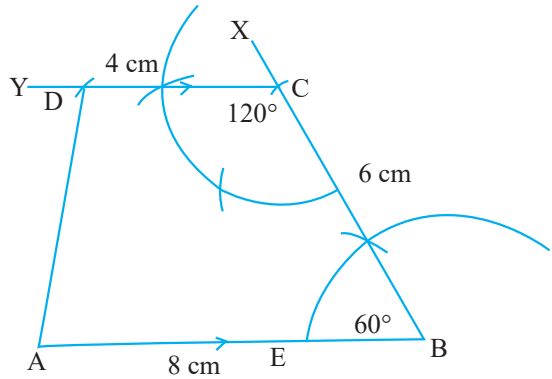

Therefore, the required trapezium is ABCD.

(b) When all the four sides are given and the parallel sides are marked

Construct a trapezium ABCD having $AB = 7$ cm, $BC = CD = 4$ cm, $DA = 5$ cm and $AB \parallel CD$.

Solution

Draw a rough diagram of trapezium ABCD from the given information.

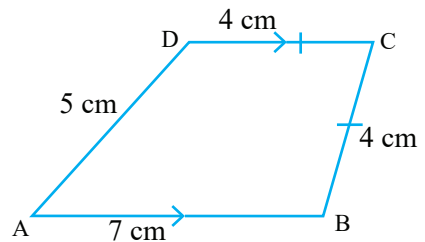

Steps

1. Draw a line segment $AB = 7$ cm.
2. Draw lines $AE = DC = 4$ cm in which point E lies on line segment AB.
3. Cut from point E with an arc 5 cm.
4. Again, cut from point B with an arc 4 cm that meet the point C.
5. Cut from point C with an arc 4 cm.
6. Again, cut from point A with an arc 5 cm that meet the point D.
7. Join B and C, C and D and D and A.

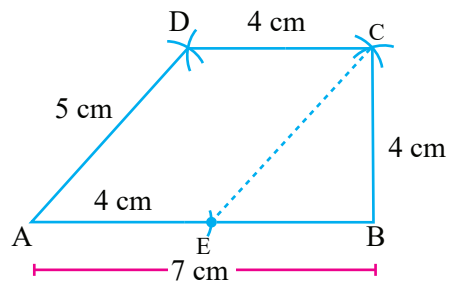

Therefore, the required trapezium is ABCD.

(c) When three sides and one diagonal are given

Construct a trapezium having $AB = 10$ cm, $BC = 6$ cm, $AC = 8$ cm and $AB \parallel CD$

Solution

Draw a rough diagram of trapezium based on the given information.

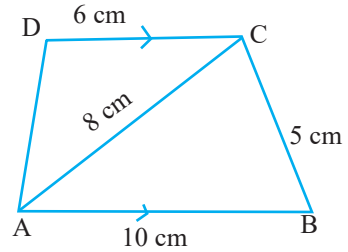

Steps

1. Draw a line segment $AB = 10$ cm.
2. Cut from points A and B with an arc of 8 cm and 5 cm respectively and intersect at point C. Draw lines $AE = DC = 4$ cm.
3. Join the points A and C and B and C.
4. Draw equal angles $\angle BAC$ and $\angle ACX$ with the help of compass.
5. Cut from point C with an arc 6 cm that meet at point D.
6. Join the points D and A.

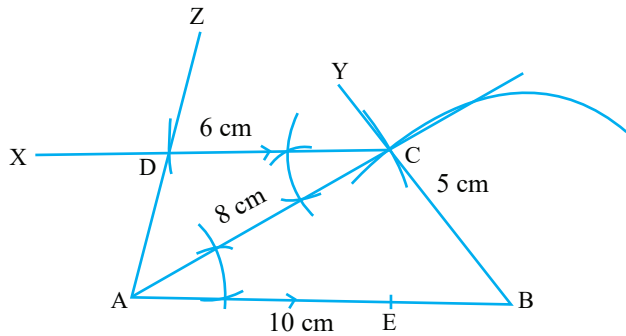

Therefore, the required trapezium is ABCD.

(d) When two sides and two angles are given

Construct a trapezium ABCD having $AB = 7$ cm, $BC = 6$ cm $\angle BAD = 90^\circ$ and $\angle ABC = 75^\circ$

Solution

Draw a rough diagram of trapezium ABCD from the given information.

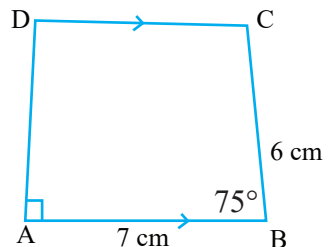

Steps

1. Draw a line segment $AB = 7$ cm
2. Draw angles $BAX = 90^\circ$ and $ABY = 75^\circ$ at points A and B respectively.
3. Cut from point B with an arc 6 cm at point C
4. Draw an angle 105° at point C that cut at point D.

Therefore, the required trapezium is ABCD.

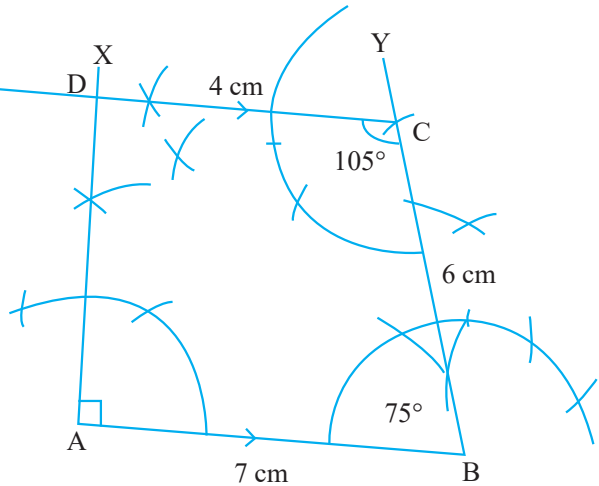

Exercise 15.2

Construct trapeziums from the following information:

1. Construct a trapezium ABCD having $AB = 6$ cm, $BC = 4$ cm, $CD = 3.2$ cm, $\angle B = 75^\circ$ and $DC \parallel AB$
2. Construct a trapezium ABCD having $AB \parallel DC$, $AB = 7$ cm, $BC = 5$ cm, $AD = 6.5$ cm and $\angle B = 60^\circ$
3. Construct a trapezium ABCD having $AB \parallel CD$, $AB = 8$ cm, $BC = 6$ cm, $CD = 4$ cm and $\angle C = 120^\circ$
4. Construct a trapezium PQRS having $PQ = 10$ cm, $QR = 4$ cm, $RS = 6$ cm and $SP = 3$ cm with $PQ \parallel SR$

Answer

Show your construction to your teacher.

15.3 Construction of rhombus

(a) When the length of two diagonals are given

Construct a rhombus ABCD having diagonals $AC = 8.6$ cm and $BD = 6.2$ cm.

Solution

Rough diagram

Draw a rough rhombus from the given information.

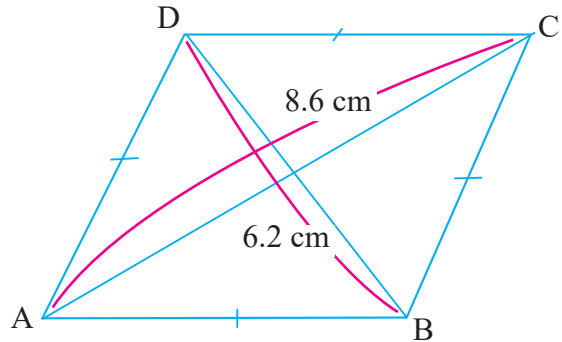

Steps

1. Draw a line segment AC having length 8.6 cm.
2. And then, draw perpendicular bisector PQ of line AB.

The intersecting point of PQ and AB is O.

3. Cut from point O with an arc 3.1 cm (half of BD) into both sides at points B and D as well cut from point O with an arc 4.3 cm (half of AC) into both sides at points A and C.
4. Join the points A and B, B and C, C and D, and A and D respectively.

Therefore, the required rhombus is ABCD.

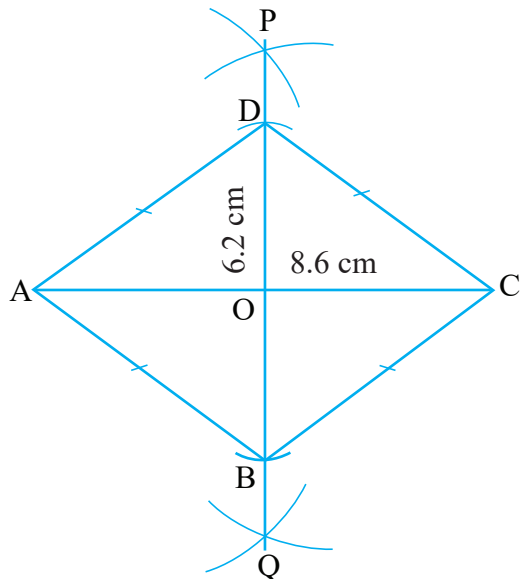

(b) When a side length and an vertex angle are given

Construct a rhombus PQRS having side $PQ = 5.3$ cm and vertex angle $\angle PQR = 45^\circ$.

Solution

Rough diagram

First of all, draw a rough diagram according to the given information.

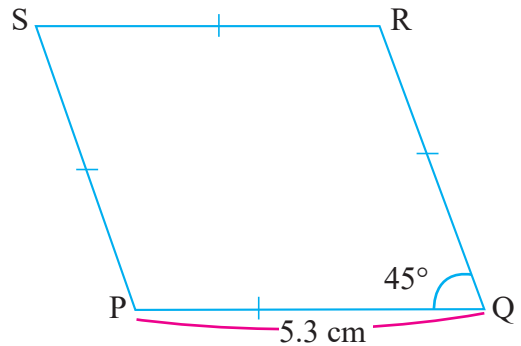

Steps

1. Draw a line segment PQ of length 5.3 cm.
2. Draw an angle $\angle PQR = 45^\circ$ at point Q .
3. Cut at point R from point Q with an arc 5.3 cm.
4. Again, cut from the points P and R with the same arc 5.3 cm that intersect at point S .
5. Joining the points P and S , and R and S with a help of scale.

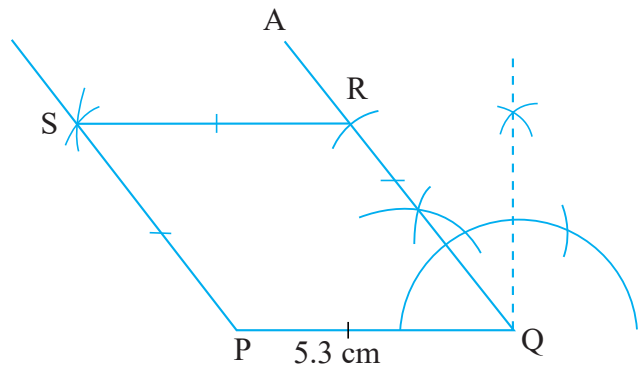

Therefore, the required rhombus is PQRS.

(c) A side length and length of a diagonal are given

Construct a rhombus EFGH having a side $EF = 5.5$ cm and diagonal $EG = 7$ cm.

Solution

Rough diagram

At first, draw a rough diagram of rhombus EFGH based on the given information.

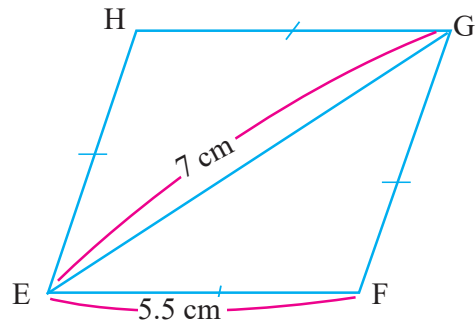

Steps

1. Draw a line segment $EG = 7$ cm.
2. Draw a perpendicular bisector PQ of the line EG using compass.
3. Cut from point E with an arc 5.5 cm towards OP and OQ , and name the intersecting points H and F respectively.
4. Joining the points E and F , F and G , G and H , and H and E using scale.

Therefore, the required rhombus is EFGH.

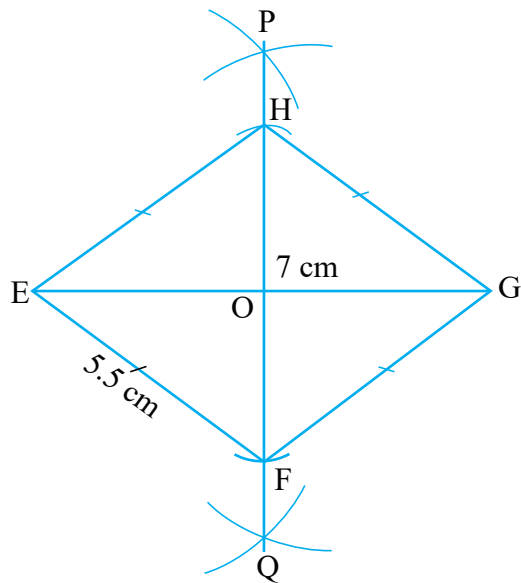

(d) A side length and an angle between the side and diagonal are given

Construct a rhombus ABCD having side AB = 4.7 cm and $\angle CAB = 60^\circ$.

Solution

Rough diagram

Draw a rough diagram of rhombus ABCD based on the given information.

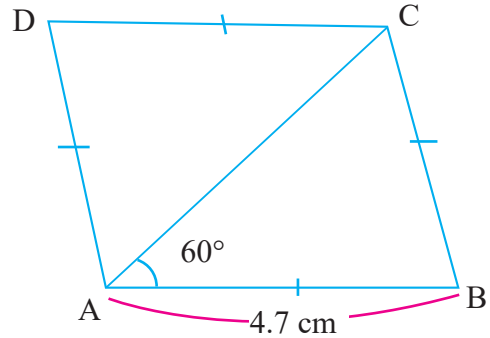

Steps

1. Draw line segment AB having length 4.7 cm.
2. Draw an angle $\angle PAB = 60^\circ$ at point A.
3. Cut from the point A with an arc 4.7 cm at point C of the line AP using compass.
4. Again, cut with the same arc from point A towards up and cut from point C towards left those intersect at a point D.
5. Join the points B and C, C and D, and A and D.

Therefore, the required rhombus is ABCD.

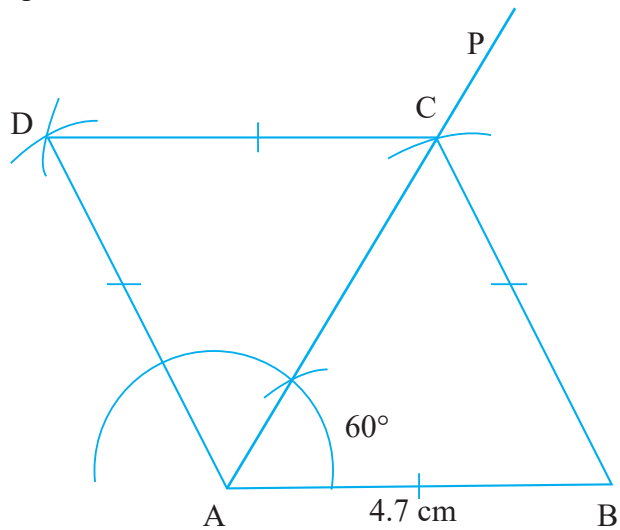

Exercise 15.3

Construct rhombus from the following conditions.

1. (a) Rhombus PQRS having diagonal $PR = 9.4$ cm and $QS = 7.2$ cm
(b) Rhombus WXYZ having diagonal $WY = 6.6$ cm and $XZ = 4.8$ cm
(c) Rhombus ABCD having diagonal $AC = 5.9$ cm and $BD = 6.8$ cm
2. (a) Rhombus EFGH having side $EF = 6.3$ cm and vertex $\angle E = 75^\circ$
(b) Rhombus ABCD having side $BC = 5.5$ cm and vertex $\angle C = 60^\circ$
(c) Rhombus IJKL having side $IJ = 5.1$ cm and vertex $\angle I = 105^\circ$
(d) Rhombus WXYZ having side $WX = 6.2$ cm and vertex $\angle Y = 45^\circ$
3. (a) Rhombus ABCD having side $AB = 5.8$ cm and diagonal $BD = 7.3$ cm
b) Rhombus PQRS having side $QR = 4.3$ cm and diagonal $PR = 6.5$ cm
c) Rhombus EFGH having side $EF = 5.1$ cm and diagonal $EG = 8.2$ cm
4. (a) Rhombus ABCD having side $AB = 5.3$ cm and $\angle ABD = 30^\circ$
(b) Rhombus PQRS having side $QR = 6.1$ cm and $\angle PQR = 75^\circ$
(c) Rhombus EFGH having side $GH = 4.6$ cm and $\angle GEF = 60^\circ$
(d) Rhombus WXYZ having side $WX = 5.6$ cm and $\angle WXZ = 45^\circ$

Answer

Show the construction to your teacher.

16.0 Review

Make a pair with your nearby friend, and discuss and identify about the different parts of circle based on the following figure. Present the result in your class.

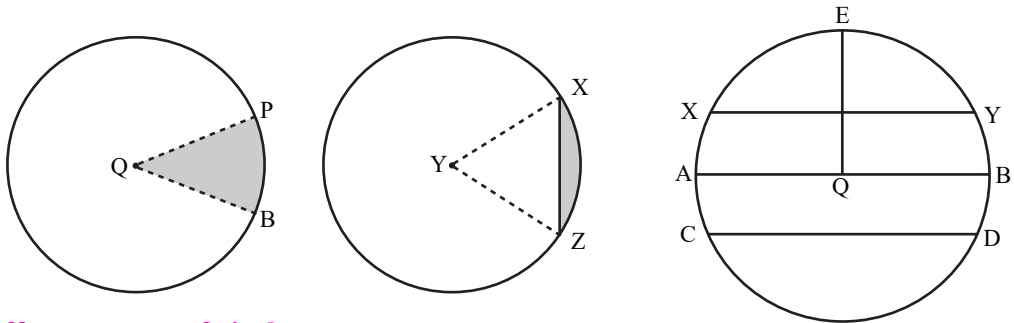

Different parts of circle

- (i) Center
- (ii) Radius
- (iii) Circumference
- (iv) Chord
- (v) Diameter
- (vi) Arc
- (vii) Semi-circle
- (viii) Sector
- (ix) Segment

16.1 Theorems related to chord of a circle

The line joining two circumference points of a circle is called chord. The diameter of any circle is also a chord. The largest chord is diameter.

Draw a circle with centre O in a tracing paper or plane paper as shown in the given figure.

Draw a chord AB. And then, fold the circle through centre as shown in the given figure.

Measure whether the folding (dotted) line have cut in equal part or not the AB line.

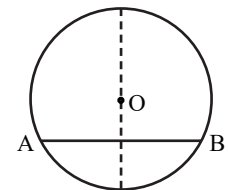

Theorem 1

The perpendicular drawn from the centre of a circle to a chord bisects the chord.

Experimental verification:

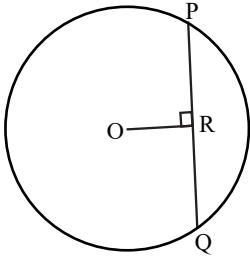

Figure I

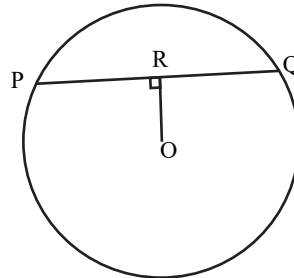

Figure II

Construct two circles having different radius and centre as shown in the above figure.

Draw a chord PQ in each circle and also draw a perpendicular OR from the center O in the chord using a set square.

Measure the segment PR and QR and tabulate in the following table.

Figure	PR	RQ	glthf
I.			
II.			

Conclusion: Therefore, the perpendicular drawn from the centre of a circle to a chord bisects the chord.

Theoretical proof

Given

In the given figure, O is a center of a circle and AB is a chord in which $OC \perp AB$.

To prove:

$AC = BC$

Construction: Join AO and BO

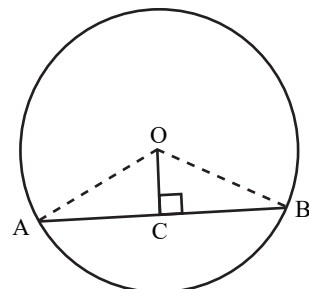

Proof:

S. No.	Statements	S. No.	Reasons
1.	In $\triangle OCA$ and $\triangle OCB$	1.	
(i)	$\angle OCA = \angle OCB$ (r)	(i)	Given $OC \perp AB$
(ii)	$OA = OB$ (h)	(ii)	Radius of the same circle
(iii)	$OC = OC$ (s)	(iii)	Common side
2.	$\triangle OCA \cong \triangle OCB$	2.	By RHS theorem
3.	$AC = BC$	3.	Corresponding sides of congruent triangle

proved

Theorem 2

The line joining the centre of a circle and the mid-point of a chord is perpendicular to the chord.

Experimental verification

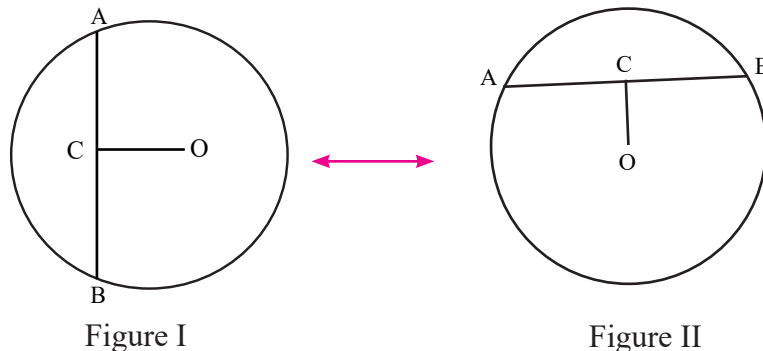

Draw two different size circles having centre O. Draw a chord AB of the circle, and mark the mid-point of chord AB with the help of ruler. And then, join the centre of the circle O and mid-point C.

Measure the angles $\angle OCA$ and $\angle OCB$ using protractor and tabulate in the following table.

Figure	$\angle OCA$	$\angle OCB$	Results
I.			
II.			

Conclusion: Therefore, the line joining the centre of a circle and the mid-point of a chord is perpendicular to the chord.

Theoretical proof

Given

In the given figure, O is a center of a circle and CD is a chord in which $CM = MD$.

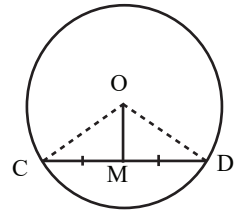

To prove: $OM \perp CD$

Construction: Join OC and OD.

Proof:

S. No.	Statements	S. No.	Reasons
1.	In $\triangle OMC$ and $\triangle OMD$	1.	
(i)	$OC = OD$ (s)	(i)	Radius of the same circle
(ii)	$OM = OM$ (s)	(ii)	Common side
(iii)	$CM = DM$ (s)	(iii)	Given $CM = DM$
2.	$\triangle OMC \cong \triangle OMD$	2.	By SSS theorem
3.	$\angle OMC = \angle OMD$	3.	Corresponding angles of congruent triangle
4.	$\angle OMC + \angle OMD = 180^\circ$ $\angle OMC + \angle OMC = 180^\circ$ or, $2\angle OMC = 180^\circ$ or, $\angle OMC = 90^\circ$	4.	The sum of adjacent angles in a straight line
5.	$OM \perp CD$	5.	From statement 4 $\angle OMC = 90^\circ$

proved

Activity 1

Make a circle of cardboard.

Fold the cardboard circle into two halves as shown in the figure (ii).

Again, fold as shown in the figure (iii) and (iv).

At last, re-open the folded cardboard circle.

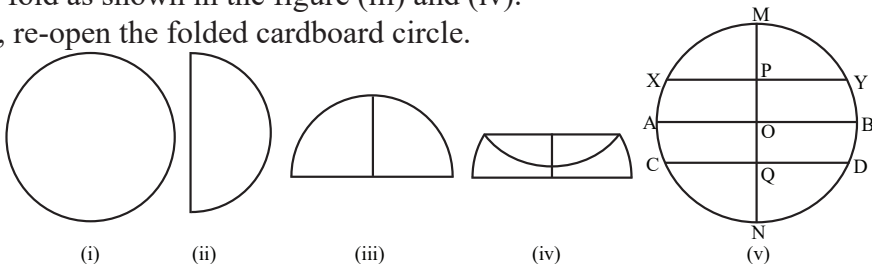

Now, what may be the relation of chords XY, AB, CD and MN? Observe and draw the conclusion whether the mid-points of XY, AB and CD lie on the vertical line MN or not.

Theorem 3

Equal chords of a circle are equidistant from the centre.

Activity 2

Draw a circle having centre O as in the given figure.

Again, draw two equal chords AB and CD in this figure.

Cut and separate the circle with the help of scissor.

Now, fold at point that divides the chord AB and CD into two equal parts. In this case, check and observe whether the points of the chords are equidistant or not from the centre of the circle.

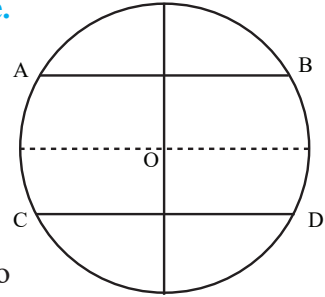

Experimental verification

Draw two different sized circles having centre O . Draw a pair of equal chords PQ and AB to both sides of the centre of the circle. Then, draw perpendiculars to both the chords PQ and AB from the centre of the circle.

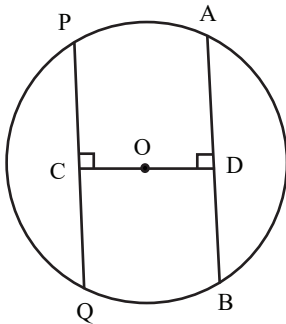

Figure I

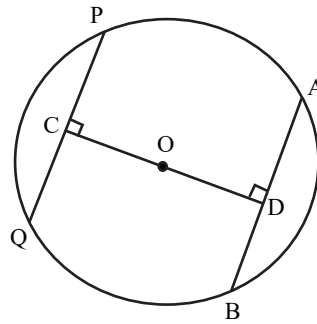

Figure II

Now, measure the distance between centre and chords using ruler and tabulate them as follows:

Figure	OC	OD	Result
I.			
II.			

Conclusion: Therefore, the equal chords of a circle are equidistant from the centre.

Theorem 4 (Converse of theorem 3)

Chords which are equidistant from the centre of a circle are equal.

Experimental verification

Draw two different sized circles having centre O as shown in the following figure. Draw two chords PQ and AB to both sides which are equidistant from the centre. Then, draw perpendiculars to both the chords PQ and AB from the centre of the circle with the help of set square. That is, draw $OC \perp PQ$ and $OD \perp AB$ using set squares, in which $OC = OD$.

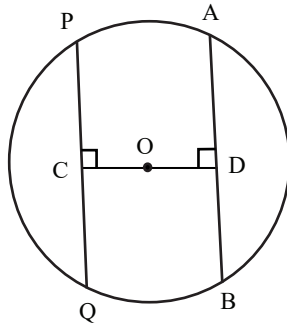

Figure I

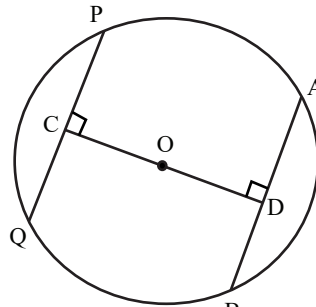

Figure II

Now, measure the length of chords PQ and AB using ruler and tabulate them as follows:

Figure	PQ	AB	Results
I.			
II.			

Conclusion: The chords which are equidistant from the centre of a circle are equal.

Example 1

If radius and chord of a circle are 10 cm and 16 cm respectively, then find the distance between centre and the chord.

Solution

In figure, O is a centre of a circle. OM is perpendicular to chord AB .

Here, $OA = 10$ cm and $AB = 16$ cm.

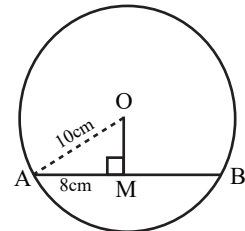

$$AM = \frac{1}{2} AB = 8 \text{ cm} \quad [\because \text{The perpendicular drawn from centre to the chord}]$$

$$\text{Now, } \triangle OMA, OA^2 = OM^2 + AM^2 \quad [\because \text{Pythagoras theorem}]$$

$$\text{or, } 102 = OM^2 + 82$$

$$\text{or, } 100 = OM^2 + 64$$

$$\text{or, } 100 - 64 = OM^2$$

$$\text{or, } 36 = OM^2$$

$$\text{or, } \sqrt{36} = OM$$

$$\text{or, } OM = 6 \text{ cm}$$

\therefore The distance between centre and the chord is 6 cm.

Example 2

In given figure, O is centre of a circle and AB and AC are chords. If $\angle BAO = \angle CAO$, then prove that $AB = AC$.

Solution

Given: O is centre of the given circle and AB and AC are chords. And $\angle BAO = \angle CAO$.

To prove: $AB = AC$

Construction: $OF \perp AB$ and $OE \perp AC$

$$AB = AC$$

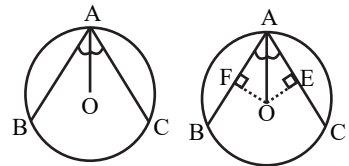

Proof:

S. No.	Statements	S. No.	Reasons
1.	In $\triangle OFA$ and $\triangle OEA$	1.	
(i)	$OA = OA$ (s)	(i)	Common side
(ii)	$\angle OAF = \angle OAE$ (a)	(ii)	Given
(iii)	$\angle AFO = \angle AEO$ (a)	(iii)	Both 90°
2.	$\triangle OFA \cong \triangle OEA$	2.	By SAA theorem
3.	$AF = AE$	3.	Corresponding sides of congruent triangles
4.	$AF = BF, AE = EC$	4.	Having $OF \perp AB$ and $OE \perp AC$
5.	$2AF = 2AE$ or, $AB = AC$	5.	From statements 3 and 4

Proved

Example 3

A straight line cuts at four points A, B, C and D of two concentric circles having common centre O as shown in the given figure. Then prove that $AB = CD$.

Given: O is a centre of concentric circles. The line AD cuts the concentric circles at points A, B, C and D.

To prove: $AB = CD$

Construction: $OM \perp AD$

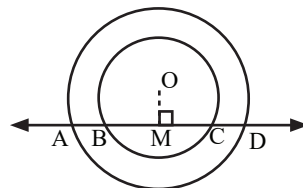

Proof:

S. No.	Statements	S. No.	Reasons
1.	$AM = DM$	1.	Perpendicular drawn from centre to the chord.
2.	$BM = CM$	2.	From statement 1
3.	$AB = CD$	3.	Subtract statement 2 from 1

Proved

Exercise 16

- Find the length of a chord at a distance 4 cm from the centre of a circle having radius 5 cm.
 - Find the length of a chord at a distance 8 cm from the centre of a circle having diameter 34 cm.
 - Find the distance between centre and the chord of length 20 cm of a circle having radius 26 cm.
 - Find the distance between centre and the chord of length 48 cm of a circle having radius 26 cm.
 - If the distance between centre and the chord having length of 24 cm is 10 cm, then find the diameter of the circle.
 - There are two parallel chords $AB = 6$ cm and $CD = 12$ cm in the same side of a circle having centre O. Find the radius of the circle, if the distance between two radius is 3 cm.
 - There are two parallel chords $PQ = 8$ cm and $XY = 6$ cm in the opposite side of a circle having centre O. Find the distance between PQ and XY, if the radius of the circle is 5 cm.

2. Draw a circle with centre O and having radius 4 cm. Again, draw a chord AB of length 5 cm. Would you be able to draw a circle having 2 cm radius passing the points A and B? Give reason.

3. In the given figure, X and Y are the centre of two circles. The line CD cut at point M and N of circle with centre X; and XY cut at point P, then prove that

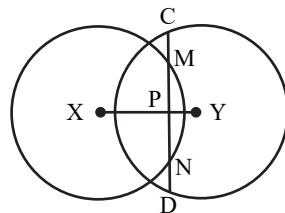

- (i) $CM = DN$
(ii) $CN = DM$

4. In the given figure, AB and BC are chords of a circle ABC. Trace the figure in to your copy and find the centre of the circle.

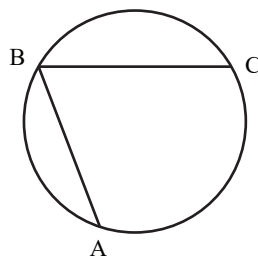

Answer

1. (a) 6 cm (b) 30 cm (c) 24 cm
(d) 10 cm (e) 52 cm (f) $3\sqrt{5}$ cm
(g) 7 cm
2. No, we can't, because the length of radius is half of AB.
- 3 - 4. Show to your teacher.

Lesson 17

Classification and Presentation of Data

17.0 Review

The bar diagram of students of Shree Janabikash Secondary School from class 5 to 10 is given as follows. Study the bar diagram and answer the following questions:

**The data of Students of
Shree Janabikash Secondary School from Grade 5 to 10**

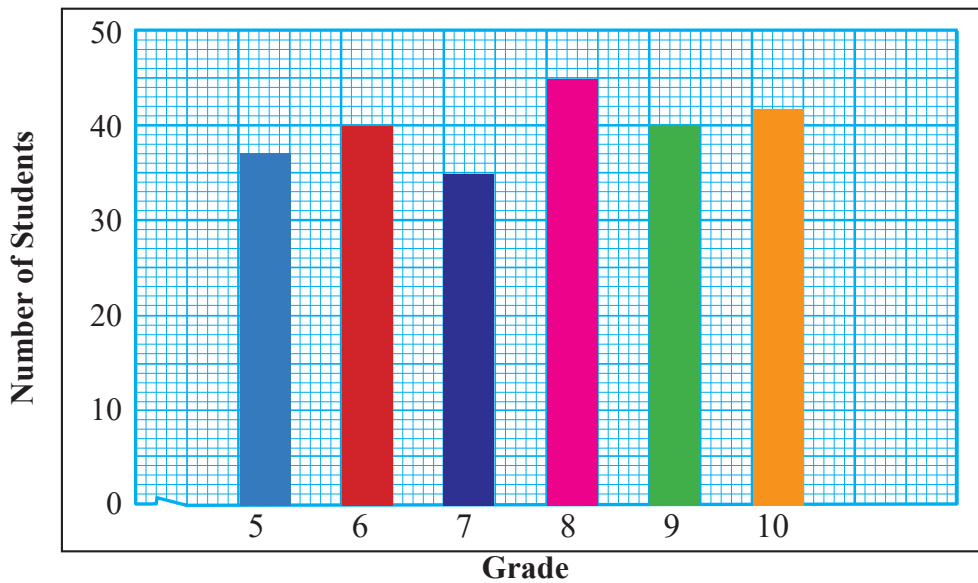

- How many total students are there from grade 5 to grade 10?
- In which grade has the highest number of students and how many are there?
- In which grade has the lowest number of students and how many are there?
- In which grade has the equal number of students?

17.1 Classification of data

Activity 1

The marks obtained in mathematics by 40 students of grade 8 are given below:

73, 40, 65, 45, 53, 49, 40, 56, 45, 53,
75, 49, 63, 75, 45, 83, 73, 92, 48, 89,
65, 73, 73, 94, 75, 92, 82, 89, 45, 90,
48, 40, 82, 49, 73, 56, 63, 65, 60, 60

Complete the following frequency distribution table of from the given data.

I. A table of marks obtained in mathematics of grade 8

Marks Obtained	Tally bar	Frequency
40		3
45		4
48		
49		
53		
56		
60		
63		
65		
73		
75		
82		
83		
89		
90		
92		
94		
		Total number (N) =

II. Again, complete the following continuous frequency table having class interval 10/10 that starts from the class 40 – 50.

Marks Obtained	Tally bar	Frequency
40 - 50		12
50 - 60		
60 - 70		
70 - 80		
80 - 90		
90 - 100		
		Total number (N) =

Answer the following questions based on the above two table:

- Are there any changes in total number of students from the above two table?
- How many ways were the above data presented through?
- Could we prepare the table (II) with class interval 5/5?
- How is the frequency 12 obtained the class interval 40 – 50?

The frequency table prepared by calculating the frequency of each data that are given or collected is called the discrete series. The table prepared from the given or collected data with a certain class interval and frequency of class interval is called the continuous series.

Example 1

The marks obtained by 30 students are given as:

Ages (Year): 45, 25, 51, 35, 42, 37, 40, 35, 51, 42, 42, 42, 37, 40, 35, 37, 42, 40, 37, 35, 37, 42, 51, 25, 42, 40, 45, 37, 40, 42

Prepare a discrete distribution from the above data.

Solution

Obtained Marks	Tally bar	Frequency
25		2
35		4
37		6
40		5
42		8
45		2
51		3
		Total number (N) = 30

Activity 2

The ages of grade 5 to 9 students studying in Setidevi Secondary School are as follows:

Ages (years)	10	11	12	13	14	15
No. of Students	40	30	33	48	37	42

Study the given table and answer the following questions:

- Which type of distribution is called the above distribution?
- Prepare a distribution having 10 years, 11 or less year, 12 or less year, 13 or less year, 14 or less year, 15 or less year of the above data.
- What type of distribution in (b) is called?

From the above discussion

- The distribution is called as discrete distribution.

(b)

Ages (years)	Frequency	Cumulative frequency
10	40	40
11	30	$40 + 30 = 70$
12	33	$70 + 33 = 103$
13	48	$103 + 48 = 151$
14	37	$151 + 37 = 188$
15	42	$188 + 42 = 230$
	Total number (N) = 230	

(c) Cumulative frequency table

Example 2

Prepare a cumulative frequency distribution of the following table

Wages (Rs.)	50	55	60	65	70	75
No. of workers	4	8	7	6	9	6

Solution

Wages (Rs.)	No. of workers	Cumulative frequency
50	4	4
55	8	$4 + 8 = 12$
60	7	$12 + 7 = 19$
65	6	$19 + 6 = 25$
70	9	$25 + 9 = 34$
75	6	$34 + 6 = 40$
	Total number (N) = 40	

Activity 3

Study the following data and answer the following:

Wages (Rs.)	0 – 10	10 – 20	20 – 30	30 – 40	40 – 50	50 – 60
No. of workers	6	13	22	17	7	5

- (a) Which type of distribution is called the above distribution?
- (b) How many students are there who obtained less than 10 marks?
- (c) How many students are there who obtained greater than 0 or more marks?
- (d) How can we construct a less than cumulative frequency table?
- (e) How can we construct a more than cumulative frequency table?

From the above discussion,

- (a) The given data is in the form of continuous distribution.
- (b) There are 6 students who obtained less than 10 marks.
- (c) There are 70 students who obtained greater than 0 or more marks, i.e all students?
- (d) We can construct a less than cumulative frequency table as follows:

Obtained Marks	Cumulative frequency
Less than 10 (<10)	6
Less than 20 (<20)	$6 + 13 = 19$
Less than 30 (<30)	$19 + 22 = 41$
Less than 40 (<40)	$41 + 17 = 58$
Less than 50 (<50)	$58 + 7 = 65$
Less than 60 (<60)	$65 + 5 = 70$

- (e) We can construct a more than cumulative frequency table as follows:

Obtained Marks	Cumulative frequency
More than 0 (≥ 0)	70
More than 10 (≥ 10)	$70 - 6 = 64$
More than 20 (≥ 20)	$64 - 13 = 51$
More than 30 (≥ 30)	$51 - 22 = 29$
More than 40 (≥ 40)	$29 - 17 = 12$
More than 50 (>50)	$12 - 7 = 5$

The table in which the frequencies are added one by one is called cumulative frequency table. To prepare the cumulative frequency table, we should arrange the frequency in increasing or decreasing order. Cumulative frequency table of continuous data can be presented into two methods: less than cumulative frequency table and more than cumulative frequency table.

Example 3

The marks obtained in mathematics by 35 students of grade 9 of full marks 60 are given as follows:

39, 50, 42, 34, 25, 35, 36, 46, 34, 32, 44, 43, 24, 43, 40, 36, 45, 34, 42, 37, 35, 43, 58, 34, 35, 33, 24, 40, 43, 52, 57, 33, 50, 38, 24

- Present the given marks in continuous data.
- Present the given data in less than cumulative frequency table.
- Present the given data in more than cumulative frequency table.

Solution

- Here, minimum marks and maximum marks are 20 and 58 respectively. Thus, taking the interval of 10/10 we can find the first class interval as 20 – 30 in which lower limit is 20 and upper limit is 30. Lower limit is included and upper limit is not included in each and every class interval. e.g 30 is not counted in class interval 20 – 30 but it is count in class 30 – 40.

Class interval	frequency
20 - 30	4
30 - 40	15
40 -50	11
50 - 60	5
	Total number (N) = 35

- Construction of less than cumulative frequency curve

Class interval	Frequency
Less than 30 (<30)	4
Less than 40 (<40)	4 + 15 = 19
Less than 50 (<50)	19 + 11 = 30
Less than 60 (<60)	30 + 5 = 35

- (c) Construction of less than cumulative frequency curve

Class interval	Frequency
20 or more than (≥ 20)	35
30 or more than (≥ 30)	$35 - 4 = 31$
40 or more than (≥ 40)	$31 - 15 = 16$
50 or more than (≥ 50)	$16 - 11 = 5$

Exercise 17.1

1. The marks with full marks 10 in Science of 30 students of grade 9 are as follows:

6, 8, 10, 6, 2, 8, 4, 6, 8, 2, 4, 6, 8, 6, 8,
6, 10, 2, 4, 6, 8, 4, 2, 4, 8, 6, 4, 6, 10, 6

- (a) Convert the given discrete data into continuous data.
(b) Construct the data in cumulative frequency table.

2. Construct the given data into continuous data having the first class interval 5 – 10.

19, 5, 14, 17, 20, 21, 35, 39, 30, 31, 6, 8, 14, 28, 27, 39,
30, 31, 32, 25, 26, 10, 11, 12, 15, 28, 30, 31, 24, 22

3. Construct the following table based on the continuous data of question number of 2.

- (a) Less than cumulative frequency table
(b) More than cumulative frequency table

4. Construct a cumulative frequency table from the following discrete data.

Wages (Rs. 100)	10	20	30	40	50
No. of workers	3	7	10	8	7

5. The following table shows that the study time given by the students in mathematics per week

Hour	2 - 6	6 - 10	10 - 14	14 - 18	18 - 22
No. of students	100	250	325	200	150

Construct the following table into cumulative frequency table based on the given data.

- (a) Less than cumulative frequency table
(b) More than cumulative frequency table

Answer

Show the answer to your teacher

17.2 Presentation of data

17.2.1 Histogram

Activity 1

- (a) Draw a bar diagram from the following data.

Grade	5	6	7	8	9	10
No. of students	37	40	35	45	40	43

- (b) Answer the following questions based on the following data and histogram.

The continuous data related to the study hour in mathematics of 1025 students are presented below.

Hour (Per week)	2 - 6	6 - 10	10 - 14	14 - 18	18 - 22
No. of students	100	250	325	200	150

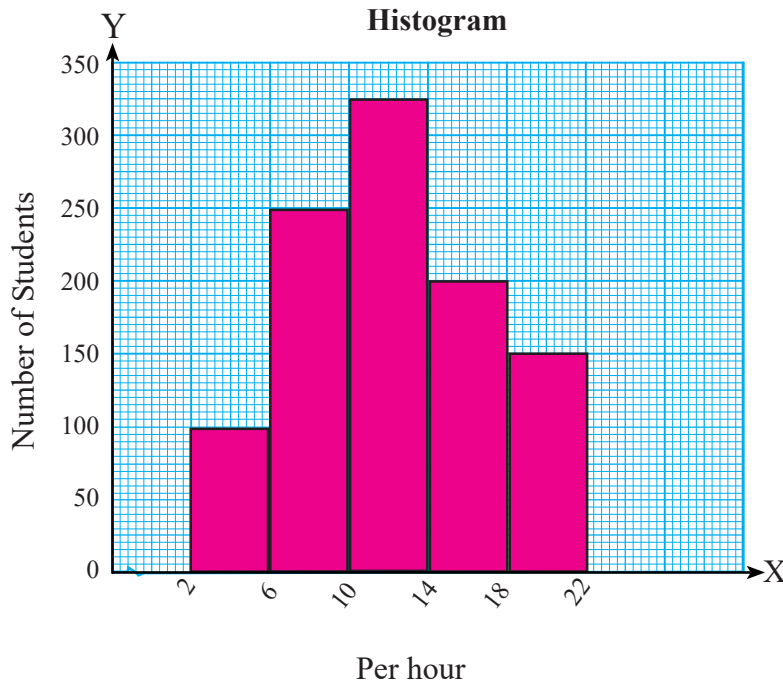

What is the difference between the bar diagram you made in (a) and histogram in (b)? Discuss in group and draw the conclusion.

A diagram consisting of rectangles whose area is proportional to the frequency of a variable and whose width is equal to the class interval is called histogram. Graphical representation of discrete data is bar diagram and histogram is for continuous data.

Steps of constructing histogram

- Draw X- and Y- axis in the graph paper.
- Put the class interval in X-axis and frequency in Y-axis with a suitable measurement.
- Draw the joined rectangles based on the specified class interval in X-axis and frequency in Y-axis as selected scale.

Example 1

Draw a histogram from the following data.

Time (Min.)	20 - 25	25 - 30	30 - 35	35 - 40	40 - 45	45 - 50
No. of machines	3	7	11	8	5	2

Solution

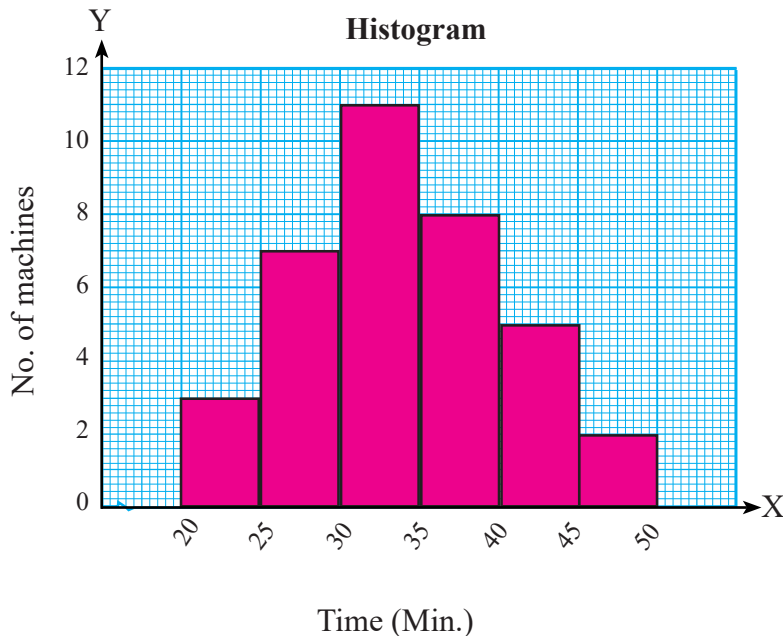

17.2.2 Frequency polygon

Activity 2

Answer following questions based on the given data and the frequency polygon constructed from the given data.

Marks obtained	10 - 20	20 - 30	30 - 40	40 - 50	50 - 60	60 - 70
No. of students	5	12	15	22	14	4

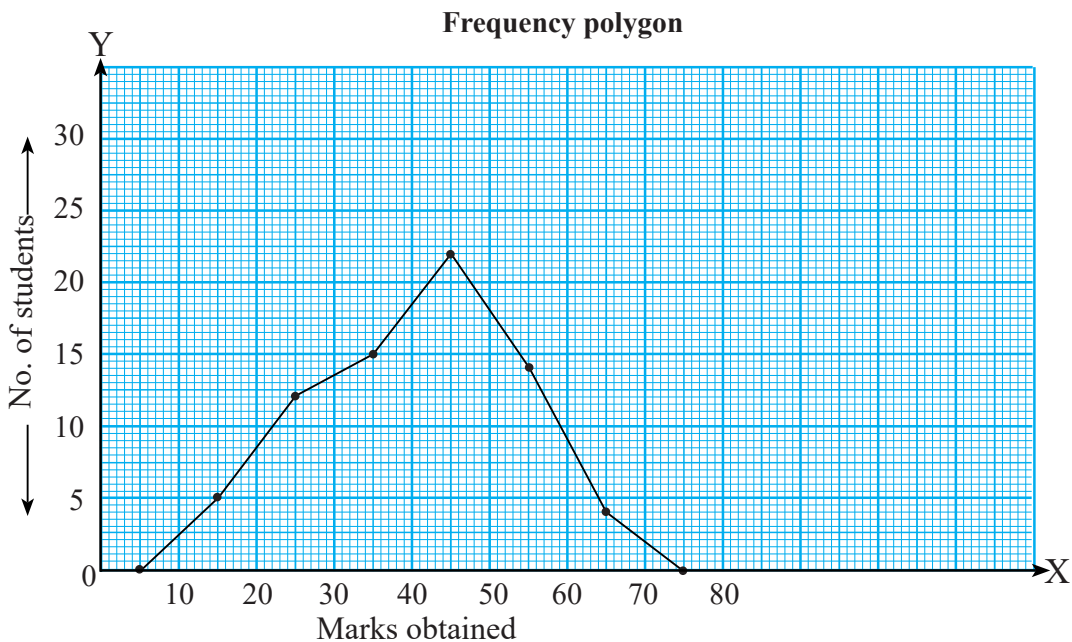

- What is the mid-value of the first class interval?
- What are the mid-values of each of these class intervals?
- Which class interval has the highest frequency?
- Which class interval has the lowest frequency?
- How can we construct the frequency polygon from continuous data drawn as above?

A line graph which joins the mid-point of the class interval containing in X-axis and the corresponding frequencies containing in Y-axis is called frequency polygon. In frequency polygon, the line is connected with the help of scale.

Steps of constructing frequency polygon

- Draw X- and Y- axis in the graph paper.
- Put the mid-value of class interval in X-axis and corresponding frequency in Y-axis with a suitable measurement.
- Now, draw the mid-value and the corresponding frequency in the graph and join them respectively.
- At last, take a lowest class-interval in left side and a highest class-interval in right side with the same scale. And then, take the mid-value of these extreme class-intervals and join them. Then, we can get the required frequency polygon.

Example 2

Draw the frequency polygon from the following data.

Weight (Kg)	10 - 20	20 - 30	30 - 40	40 - 50	50 - 60	60 - 70
No. of students	10	15	20	22	15	10

Solution

Weight	Mid-value	Frequency	Points (Mid-value, corresponding frequency)
0 - 10	$\frac{0+10}{2} = 5$	0	(5, 0)
10 - 20	$\frac{10+20}{2} = 15$	10	(15, 10)
20 - 30	$15+10 = 25$	15	(25, 15)
30 - 40	$25 + 10 = 35$	20	(35, 20)
40 - 50	$35 + 10 = 45$	22	(45, 22)
50 - 60	$45 + 10 = 55$	15	(55, 15)
60 - 70	$55+10 = 65$	10	(65, 10)
70 - 80	$65+10 = 75$	0	(75, 0)
		N = 92	

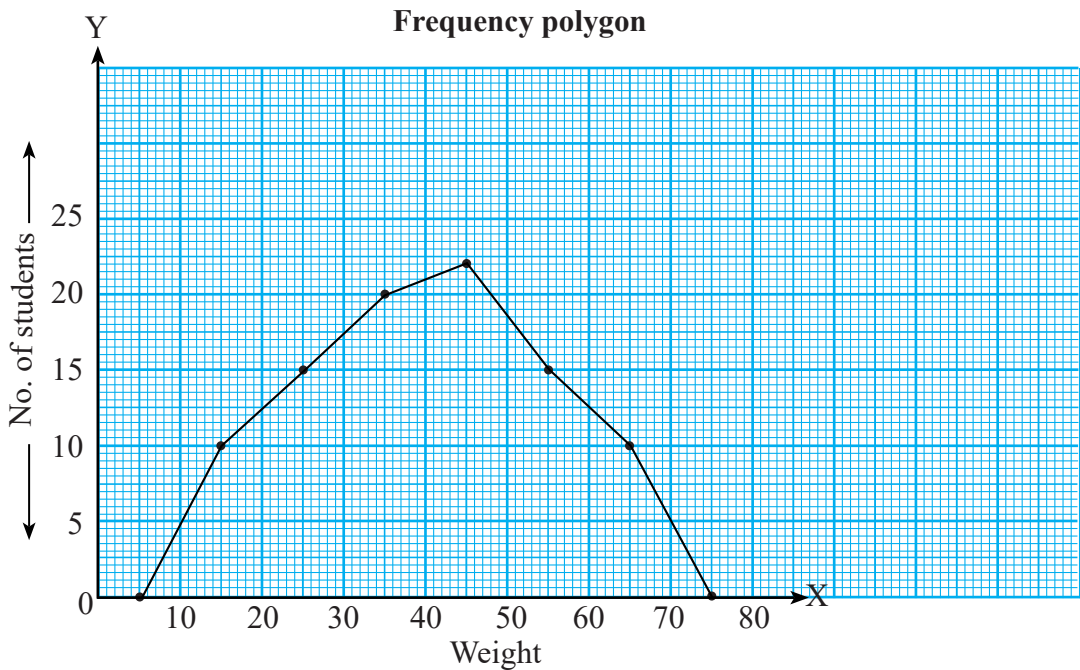

17.2.3 Cumulative frequency curve or ogive

Activity 3

The wages of labors of a company in a day is given in the following table. Study the given cumulative frequency table and cumulative frequency curve:

Wages (Rs. In 100)	3 - 4	4 - 5	5 - 6	6 - 7	7 - 8
No. of labors	12	14	8	6	10

Wages (Rs. In 100)	Cumulative frequency
Less than 4 (<4)	12
Less than 5 (<5)	$12 + 14 = 26$
Less than 6 (<6)	$26 + 8 = 34$
Less than 7 (<7)	$34 + 6 = 40$
Less than 8 (<8)	$40 + 10 = 50$

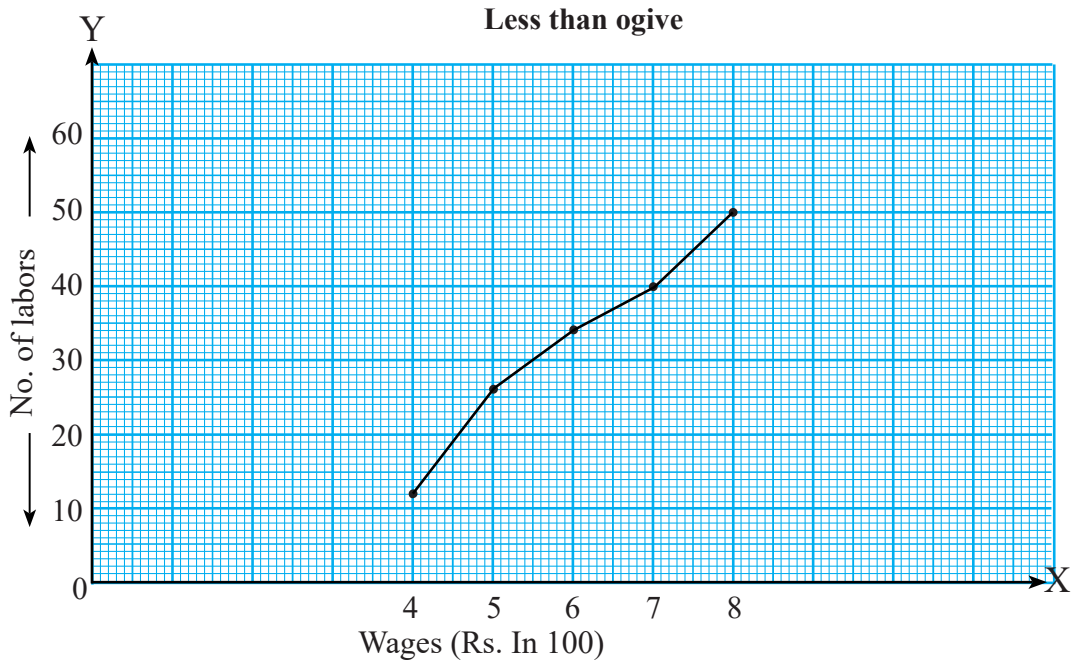

Discuss the following questions based on the above figure.

- What is the above curve line called?
- Which variable is allocated in X-axis?
- Which variable is allocated in Y-axis?
- How many labors are there in the company in total?
- How many labors are there in the company who earn less than Rs. 500 per day?
- How many labors are there in the company who earn less than Rs. 700 per day?
- How can you draw the more than ogive of the above table as like the given less than ogive?

The curve obtained by freehand drawing of the upper or lower limit of the class interval on the X-axis and the cumulative frequency of the class interval on the Y-axis is called the cumulative frequency curve or ogive.

The freehand drawing of the curved line by marking the points of upper limit of the class interval on the X-axis and the cumulative frequency of the class interval on the Y-axis is called less than cumulative frequency curve or ogive.

The freehand drawing of the curved line by marking the points of lower limit of the class interval on the X-axis and the cumulative frequency of the class interval on the Y-axis is called more than cumulative frequency curve or ogive.

Steps of constructing less than cumulative frequency curve or ogive

- Draw X- and Y- axis in the graph paper.
- Mark on X-axis in a suitable scale of upper limit of each class.
- Label the corresponding frequency in Y-axis with a suitable measurement.
- Now, locate the points that intersect the upper limit value of the class and the corresponding frequency in the graph
- Then, join the points respectively, you can get the less than frequency curve.

Steps of constructing more than cumulative frequency curve or ogive

- Draw X- and Y- axis in the graph paper.
- Mark on X-axis in a suitable scale of lower limit of each class.
- Label the corresponding frequency in Y-axis with a suitable measurement.
- Now, locate the points that intersect the lower limit value of the class and the corresponding frequency in the graph
- Then, join the points respectively, you can get the more than frequency curve.

Example 3

Draw the less than and more than curve of the following data in separate graph.

Marks	5 - 10	10 - 15	15 - 20	20 - 25	25 - 30	30 - 35	35 - 40	40 - 45
No. of Students	4	6	8	10	7	15	14	5

Solution

Now, present the data into the less than cumulative frequency of the given data.

Upper limit	Cumulative frequency	Points (Upper limit, cumulative frequency)
Less than 10 (<10)	4	(10, 4)
Less than 15 (<15)	$4 + 6 = 10$	(15, 10)
Less than 20 (< 20)	$10 + 8 = 18$	(20, 18)
Less than 25 (<25)	$18 + 10 = 28$	(25, 28)
Less than 30 (<30)	$28 + 7 = 35$	(30, 35)
Less than 35 (<35)	$35 + 15 = 50$	(35, 50)
Less than 40 (<40)	$50 + 14 = 64$	(40, 64)
Less than 45 (<45)	$64 + 5 = 69$	(45, 69)

Now, plot the points on the graph.

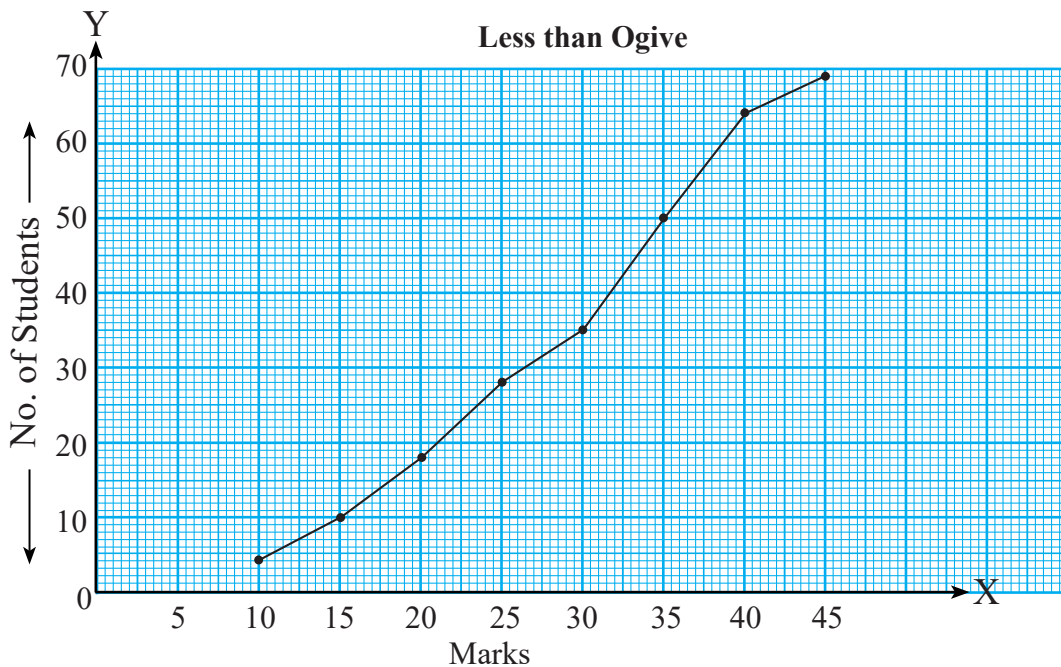

Upper limit	Cumulative frequency	Points (Upper limit, cumulative frequency)
More than 5 (≥ 5)	69	(5, 69)
More than 10 (≥ 10)	$69 - 4 = 65$	(10, 65)
More than 15 (≥ 15)	$65 - 6 = 59$	(15, 59)
More than 20 (≥ 20)	$59 - 8 = 51$	(20, 51)
More than 25 (≥ 25)	$51 - 10 = 41$	(25, 41)
More than 30 (≥ 30)	$41 - 7 = 34$	(30, 34)
More than 35 (≥ 35)	$34 - 15 = 19$	(35, 23)
More than 40 (≥ 40)	$19 - 14 = 5$	(40, 5)

Now, plot the points on the graph.

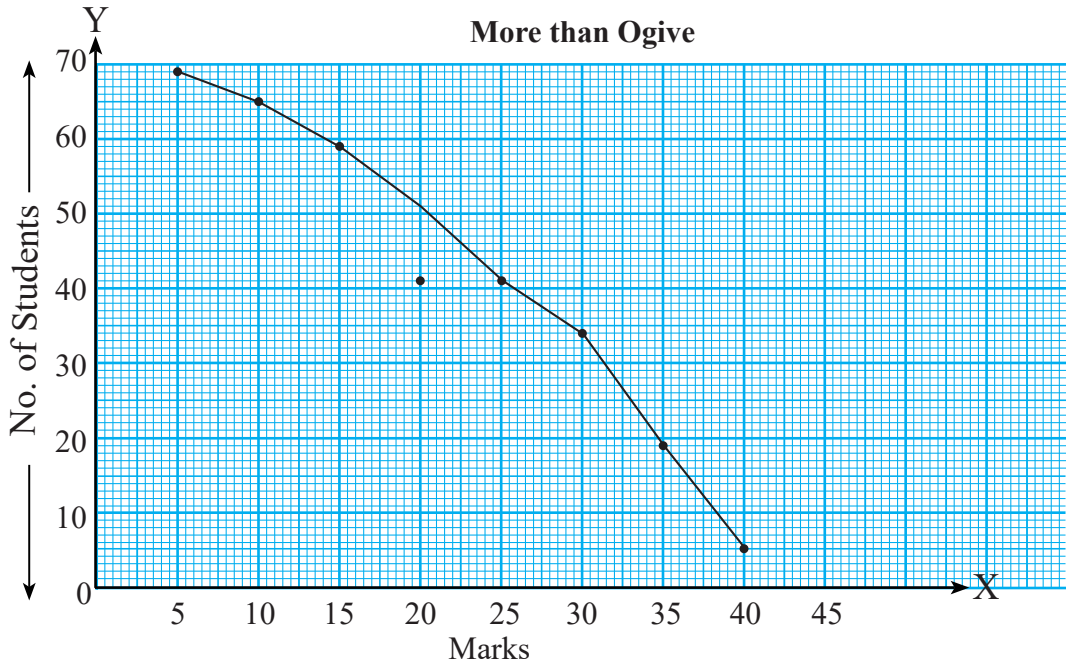

Exercise 17.2

1. Draw the histogram of the following data:

(a)

Marks	30 – 40	40 – 50	50 – 60	60 – 70	70 – 80	80 – 90
No. of Students	4	6	8	10	8	4

(b)

Age (Year)	0 – 10	10 – 20	20 – 30	30 – 40	40 – 50
No. of patients	15	12	8	20	27

(c)

Wages (Rs. In 100)	50 – 60	60 – 70	70 – 80	80 – 90	90 – 100
No. of Students	20	40	30	60	7

(d)

Class interval	0 – 5	5 – 10	10 – 15	15 – 20	20 – 25
Frequency	3	8	12	7	2

2. Draw the frequency polygon from the following data:

(a)

Marks	0 – 10	10 – 20	20 – 30	30 – 40	40 – 50
No. of Students	7	3	8	10	2

(b)

Cost of pen	10 – 20	20 – 30	30 – 40	40 – 50	50 – 60
No. of pen	15	20	30	25	5

(c)

Incomes (Rs. In 100)	20 – 35	35 – 50	50 – 65	65 – 80	80 – 95
Frequency	10	7	6	5	2

(d)

Class interval (C.I.)	11.5 – 19.5	19.5 – 27.5	27.5 – 35.5	35.5 – 43.5	43.5 – 51.5	51.5 – 59.5
Frequency(f)	7	17	10	4	1	1

3. Draw the less than and more than ogive from the following data:

(a)

Class interval (C.I.)	0 – 5	5 – 10	10 – 15	15 – 20	20 – 25	25 – 30	30 – 35
Frequency (f)	7	10	20	13	17	10	14

(b)

Marks	40 – 50	50 – 60	60 – 70	70 – 80	80 – 90	90 – 100
Frequency	4	6	16	20	30	24

(c)

Periods	0 – 6	6 – 12	12 – 18	18 – 24	24 – 30	30 – 36
No. of teachers	3	10	20	10	5	2

(d)

Time (Periods per week)	0 – 4	4 – 8	8 – 12	12 – 16	16 – 20
Frequency	28	35	66	40	31

4. Present the information of the following histogram into the frequency distribution table:

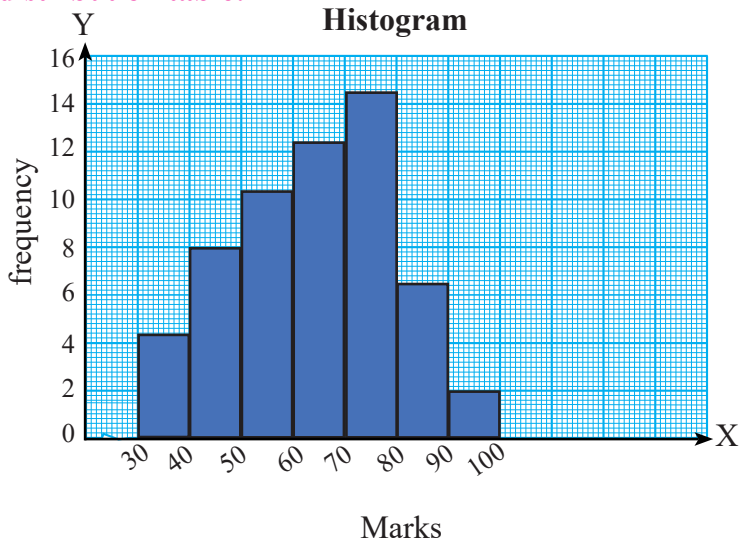

5. Present the information of the given cumulative frequency curve into the frequency distribution table:

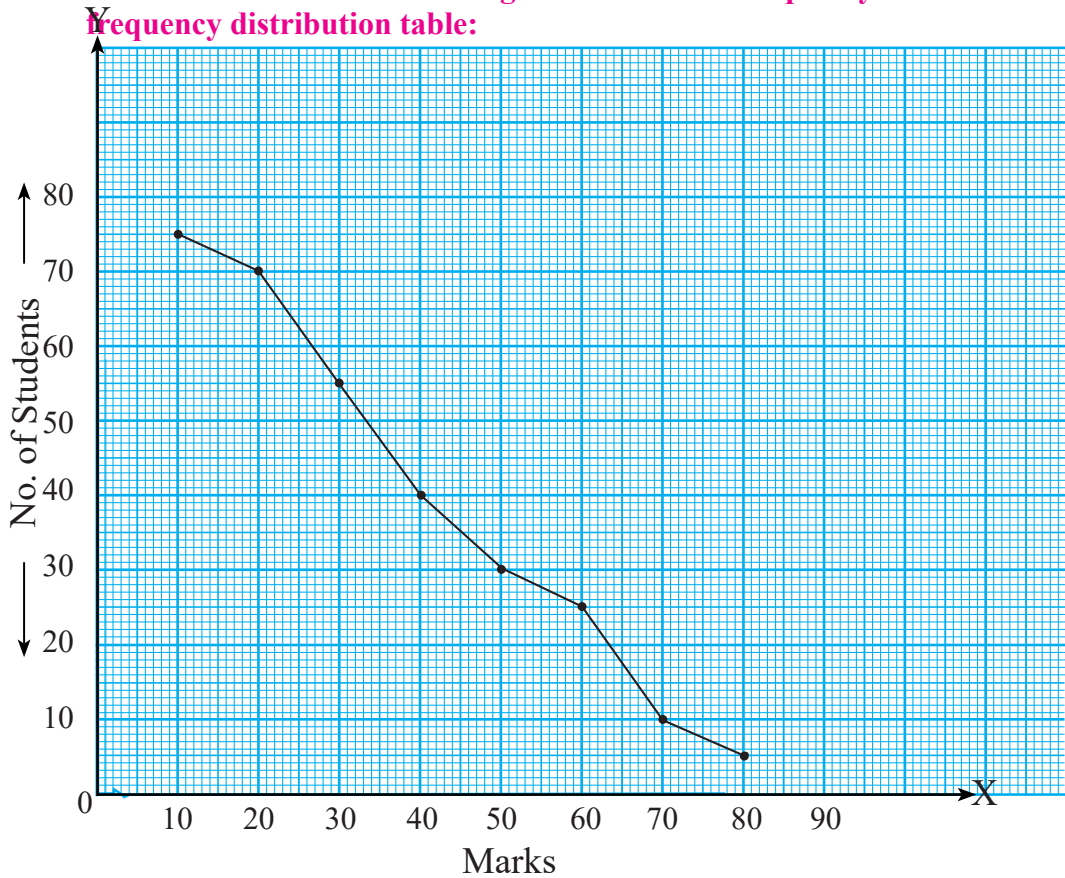

6. The monthly water consumption of 50 families in a certain locality are given as follows:

Water consumption (In 1000 liter)	0 – 4	4 – 8	8 – 12	12 – 16	16 – 20
No. of family	28	35	66	40	31

- (a) Prepare a histogram from the given information.
7. In a survey of 40 different types of foods containing the protein quantity, the data is found:

Protein (In gm): 23, 30, 20, 27, 44, 26, 35, 20, 29, 29, 25, 15, 18, 27, 19, 22, 12, 26, 34, 15, 27, 35, 26, 43, 35, 14, 24, 12, 23, 31, 40, 35, 38, 57, 22, 42, 24, 21, 27, 33

- (a) Convert the above discrete data into continuous data with class interval 10 – 15, 15 – 20, and so on.
- (b) Prepare a histogram of the given data.
- (c) Draw both the less than and more than ogive in the same graph of the data.

Project work

Divide the class in suitable group and go to one of the class from grade 6 – 10, and collect the data of number of family members the students in that class have. Then

- (a) Prepare a continuous data having 10 class interval from the given information.
- (b) Draw a histogram of the data.
- (c) Sketch the frequency polygon of the data.
- (d) Draw a less than cumulative frequency ogive.
- (e) Draw a more than cumulative frequency ogive.

Answer

Show the answers to your teacher.

Lesson 18

Measures of Central Tendency

18.0 Review

Discuss and find the solution of the following questions based on your class 8 gradesheet.

- What is the mean (average) grade point of all students?
- What is be the median grade point?
- What is the grade point secured by most of the students?

18.1 Arithmetic mean

Activity 1

The secured marks in mathematics by 32 students of grade 9 with full marks 20 are as given below:

12, 9, 14, 16, 14, 9, 12, 12, 10, 18, 14, 10, 12, 16, 18, 14, 12, 16, 16, 14, 16, 14, 14, 12, 18, 16, 16, 18, 14, 12, 14, 16

Based on the above data,

- How can we find the average? What is the average in another word colled? Find the average of the data.
- Convert the data into discrete distribution.
- What are the sum and average of the discrete data?

Here,

- The individual obtained marks are in the form of individual data of each student. Thus,

$$\begin{aligned}\sum X &= 9 + 9 + 10 + 10 + 12 + 12 + 12 + 12 + 12 + 12 + 12 + 14 + 14 + 14 + 14 + \\ &14 + 14 + 14 + 14 + 14 + 16 + 16 + 16 + 16 + 16 + 16 + 16 + 16 + 18 + 18 + 18 + \\ &18 = 448\end{aligned}$$

Total number (N) = 32

$$\bar{X} = \frac{\sum X}{N}$$

$$\bar{X} = \frac{\sum X}{N} = \frac{448}{32} = 14$$

(b) The amended data in the form of discrete data

Marks	9	10	12	14	16	18
No. of Students	2	2	7	9	8	4

(c)

Marks (X)	No. of Students (f)	f × X
9	2	18
10	2	20
12	7	84
14	9	126
16	8	128
18	4	72
	$\sum f = N = 32$	$\sum fX = 448$

Now,

Sum of marks ($\sum fX$) = 448

And total number of students ($\sum f$) = N = 32

$$\therefore \bar{X} = \frac{\sum fX}{\sum f} = \frac{\sum fX}{N} = \frac{448}{32} = 14$$

The value which is obtained from the total sum of the given data is divided by the total number of observation is called arithmetic mean or mean or average. If the data is denoted by X, then the arithmetic mean is denoted by \bar{X} . If there are large number of data, it should be converted into discrete data; and then we can easily find the average of the data. The average represents the whole data. Arithmetic mean of any data is an important tools of measures of central tendency.

Example 1

Find the arithmetic mean from the following data:

Marks	10	20	30	40	50	60
No. of Students	3	4	7	15	12	1

Solution

Here,

Marks (X)	No. of Students (f)	f × X
10	3	3 × 10 = 30
20	4	4 × 20 = 80
30	7	7 × 30 = 210
40	15	15 × 40 = 600
50	12	12 × 50 = 600
60	1	1 × 60 = 60
	$\Sigma f = N = 42$	$\Sigma fX = 1580$

Now,

$$\begin{aligned}\text{Arithmetic mean } (\bar{X}) &= \frac{\Sigma fX}{N} \\ &= \frac{1580}{42} \\ &= 37.62\end{aligned}$$

∴ Therefore, the average marks is 37.62.

Example 2

If the average wages of the given data is Rs. 4100, find the value of y.

Wages (R)	2,000	3,000	4,000	5,000	6,000	7,000
No. of labor	8	12	20	y	6	4

Solution

Here,

Wage (X)	No. of labor (f)	f × X
2000	8	8 × 2000 = 16000
3000	12	12 × 3000 = 36000
4000	20	20 × 4000 = 80000
5000	y	y × 5000 = 5000y
6000	6	6 × 6000 = 36000
7000	4	4 × 7000 = 28000
	$N = \sum f = 50 + y$	$\sum fX = 196000 + 5000y$

Now,

$$\text{Average wage } (\bar{X}) = \frac{\sum fX}{N}$$

$$\text{or, } 4100 = \frac{196000 + 5000y}{50 + y}$$

$$\text{or, } \frac{4100}{1} = \frac{196000 + 5000y}{50 + y}$$

$$\text{or, } 196000 + 5000y = 4100(50 + y)$$

$$\text{or, } 196000 + 5000y = 205000 + 4100y$$

$$\text{or, } 5000y - 4100y = 205000 - 196000$$

$$\text{or, } 900y = 9000$$

$$\text{or, } y = \frac{9000}{900}$$

$$\therefore y = 10$$

18.2 Median

Activity 2

- Stand the odd number students according to the height in the ascending order and find the height of the middle student.
- Stand the even number students according to the height in the ascending order and find the height of the middle student.

What is the height of the just middle student called? Discuss with your friends.

Activity 3

The age of awarded players playing in sports week of class 5 to 10 students are as follows:

Ages (Years): 10, 8, 12, 10, 14, 8, 10, 12, 18, 12, 14, 10, 12, 14,
16, 14, 8, 12, 14, 16, 14, 12, 10, 12, 12, 14, 16, 14, 12

Now, study the data and discuss the about the following questions.

- In which series is the data given?
- Arrange the data in ascending order.
- After arranging the data in ascending order, find the middle value of the data.
- What is called the middle value?
- Present the data in discrete series and convert the data into cumulative frequency table.
- Find the position of median.

Here,

- The given data is in individual series.
- The data is in ascending order as:
8, 8, 8, 10, 10, 10, 10, 10, 12, 12, 12, 12, 12, 12, 12, 12, 12, 12, 14, 14, 14, 14, 14,
14, 14, 14, 16, 16, 16, 18
- Here, 12 is the value which contains in the 15th position from both left and right sides. The middle value i. e. 50% of 29 data is 12. We can also find the middle value using the following formula:

$$\begin{aligned} \text{Median} &= \left(\frac{N+1}{2} \right) \text{ item} \\ &= \left(\frac{29+1}{2} \right) \\ &= \left(\frac{30}{2} \right) \\ &= 15^{\text{th}} \text{ item} \end{aligned}$$

8, 8, 8, 10, 10, 10, 10, 10, 12, 12, 12, 12, 12, 12, 12, 12, 14, 14, 14, 14, 14, 14, 14, 14, 16, 16, 16, 18

∴ Therefore, median (M_d) = 12

(e) The data can be prepared in discrete series due to their repeated frequency as follows:

Age (Years)	8	10	12	14	16	18
No. of Students	3	5	9	8	3	1

Now, construct the cumulative frequency table as follows

Age (Years)	Frequency (f)	Cumulative Frequency (cf)
8	3	3
10	5	3 + 5 = 8
12	9	8 + 9 = 17
14	8	17 + 8 = 25
16	3	25 + 3 = 28
18	1	28 + 1 = 29
	Total (N) = 29	

$$\begin{aligned} \text{(f) Median} &= \left(\frac{N+1}{2} \right)^{\text{th}} \text{ item} \\ &= \left(\frac{29+1}{2} \right)^{\text{th}} \text{ item} \\ &= \left(\frac{30}{2} \right)^{\text{th}} \text{ item} \\ &= 15^{\text{th}} \text{ item} \end{aligned}$$

According to the table 12 is 15th position value of the data. Thus, median (M_d) = 12

Further, we can justify more from the following figure:

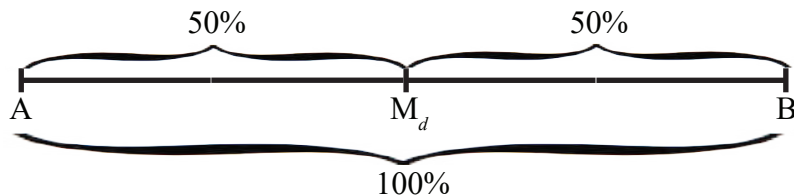

From the figure, the total distribution is represented by a line AB. The median M_d divides the line into two equal parts in left and right i. e, median divides the whole data into lower 50% and upper 50%.

The value which divides the whole distribution into two equal parts is called median. Median is denoted by M_d . Median divides the distribution into 50/50 percent. Thus, we should divide the total number of observation by 2.

To find the median of discrete distribution, firstly we should rearrange the data in ascending or descending order. In the discrete distribution, the position of the median contains in the corresponding cumulative frequency in which we operate the cumulative frequency.

The following formula is used to calculate the median:

$$\text{Total number} = N, \text{ Median} = \left(\frac{N+1}{2} \right)^{\text{th}} \text{ item}$$

Example 3

Find the median from the following data:

Rainfall (mm)	40	43	54	55	60	62
Places	3	6	9	5	4	2

Solution

First of all, we should confirm that the data is in certain order or not. If not, data should be converted into ascending or descending order. Here, the data is in ascending order. So, we need not rearrange them.

Rainfall (mm)	Places (f)	Cumulative Frequency (cf)
---------------	------------	---------------------------

40	3	3
43	6	9
54	9	18
55	5	23
60	4	27
62	2	29
	Total (N) = $\sum f = 29$	

Here, $N = 29$

We know that,

$$\text{Median} = \left(\frac{N+1}{2} \right)^{\text{th}} \text{ item}$$

$$= \left(\frac{29+1}{2} \right)^{\text{th}} \text{ item}$$

$$= \left(\frac{30}{2} \right)^{\text{th}} \text{ item}$$

$$= 15^{\text{th}} \text{ item}$$

From cf column,

$$\therefore \text{Median } (M_d) = 54 \text{ mm}$$

Example 4

Find the median from the following data:

Marks (X)	10	15	20	25	30
Frequency (f)	4	6	8	3	5

Solution

Now, present the given data into cumulative frequency table as follows:

Marks (X)	Frequency (f)	Cumulative Frequency (cf)
10	4	4
15	6	10
20	8	18
25	3	21
30	5	26
	Total (N) = 26	

Here, $N = 26$

We know that,

$$\begin{aligned} &= \left(\frac{N + 1}{2} \right) \\ &= \left(\frac{26 + 1}{2} \right)^{\text{th}} \text{ item} \\ &= \frac{27}{2}^{\text{th}} \text{ item} \\ &= 13.5^{\text{th}} \text{ item} \\ &= \frac{13^{\text{th}} \text{ item} + 14^{\text{th}} \text{ item}}{2} \\ &= \frac{20 + 20}{2} \\ &= \frac{40}{2} \end{aligned}$$

Thus, median (Md) = 20

\therefore from cf table, 13th and 14th item are 20 and 20

Example 5

Find the median from the following data:

Marks (X)	10	12	14	16	18	20
Frequency (f)	3	4	2	3	5	7

Solution

Now, present the given data into cumulative frequency table as follows:

Marks (X)	Frequency (f)	Cumulative Frequency (cf)
10	3	3
12	4	7
14	2	9
16	3	12
18	5	17
20	7	24
	Total (N) = 24	

Here, $N = 24$

We know that,

$$\begin{aligned}\text{Median} &= \left\{ \frac{N+1}{2} \right\}^{\text{th}} \text{ item} \\ &= \left\{ \frac{24+1}{2} \right\}^{\text{th}} \text{ item} \\ &= \frac{25}{2}^{\text{th}} \text{ item} \\ &= 12.5^{\text{th}} \text{ item} \\ &= \frac{12^{\text{th}} \text{ item} + 13^{\text{th}} \text{ item}}{2} \\ &= \frac{16 + 18}{2} \\ &= \frac{34}{2} \\ &= 17\end{aligned}$$

Thus, median (M_d) = 17.

18.3 Mode

Activity 4

Time (Hours): 13, 13, 15, 8, 17, 8, 10, 15, 8, 13, 17, 13, 10, 13, 12, 10, 12, 18, 15, 8, 17

- Rewrite the given data in discrete series.
- Find which one variable is the most repeated.
- What is the mode of the given data?

Here, (a)

Time (Hours)	8	10	12	13	15	17	18
Frequency (f)	4	3	2	5	3	3	1

- Here, the most repeated value is 13.
- Thus, mood (M_o) = 13

The most repeated value or having highest frequency of the given data is called mode.

Mode is denoted by M_o .

Therefore, mode (M_o) = Having highest frequency value

Example 6

Find the mode from the given data.

Marks	10	20	30	40	50	60	70
No. of Students	12	32	50	85	45	30	5

Solution

Here, the most number of students (85) secured the marks 40. That is, the marks 40 has the highest frequency 85.

Thus, mode (M_o) = 40

Exercise 18.1

1. Find the arithmetic mean of the following data:

(a)

Marks	10	20	30	40	50
Frequency	2	5	12	7	1

(b)

Age (Years)	15	25	35	45	55
No. of patients	40	30	50	20	10

(c)

X	40	50	55	62	75	80
f	4	6	10	8	5	2

(d)

Quantity of milk (ml)	500	700	1000	1500	2000
Number of family	8	5	9	5	3

2. Find the arithmetic mean of the following data:

(a)

Marks	10	20	30	40	50	60
Frequency	5	9	15	12	6	3

(b)

Weight (kg)	300	350	400	450	500	550	600
No. of people	6	12	18	14	7	4	1

(c)

Wages (Rs.)	20	25	30	35	40
No. of workers	5	7	10	5	3

(d)

Dividends (Rs.)	300	400	500	600	700
No. of workers	10	14	20	12	4

- Find the median of the data from the question number 1.
- Find the arithmetic mean of the data from the question number 2.
- Find the value in each of the following:

- (a) Find the value of k , if the mean $\bar{X} = 38$

X	30	25	35	45	55
f	2	6	k	10	3

- (b) Find the value of m , if the mean \bar{X} of the data is 175.

Marks	155	165	175	185	195
Frequency	3	m	5	4	2

- (c) Find the value of r , if the mean of the data is 24.55 kg.

Weight (Kg)	20	22	25	26	r	34
No. of persons	4	4	5	4	2	1

6. Find the mode of the following data:

(a)	X	10	15	20	25	30
	f	2	4	6	4	2

(b)	Wages (Rs.)	120	150	175	200	225	300
	No. of workers	10	12	17	13	4	3

(c)	Marks	15	25	45	55	65	70
	Frequency	7	8	12	10	3	1

(d)	Weight (Kg)	10	20	30	40	50
	No. of persons	5	9	15	12	6

7. The heights of 40 garden trees are as follows. Convert the raw data into discrete data and find the arithmetic mean and median.

Height (cm): 20, 25, 20, 10, 30, 35, 30, 25, 20, 40,

40, 35, 30, 30, 25, 20, 25, 30, 35, 30,

20, 25, 30, 25, 35, 25, 40, 25, 40, 30

25, 35, 30, 35, 35, 25, 30, 35, 30, 30

Answer

- | | | | |
|--|----------------|--------------|-------------|
| 1. (a) 30 | (b) 30.33 | (c) 58.31 | (d) 1000 ml |
| 2. (a) 30 | (b) Rs. 400 | (c) 30 kg | (d) Rs. 500 |
| 3. (a) 30 | (b) 35 | (c) 55 | (d) 1000 ml |
| 4. (a) 32.8 | (b) Rs. 416.13 | (c) 29 | (d) 476.67 |
| 5. (a) $k = 9$ | (b) $m = 2$ | (c) $r = 30$ | |
| 6. (a) 20 | (b) $? = 175$ | (c) 45 | (d) 30 kg |
| 7. 27.5 cm and 30 cm, Mean = 29 cm, Median = 30 cm | | | |

18.4 Quartiles

Activity 1

Study the given figures and answer these questions.



- In how many points should the line AB be cut to divide it into 4 equal parts?
- If the line AB is 100%, then how much what percentage do the line segments AP, PQ, QR and RB represent?

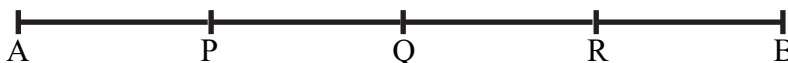

- What percentage is the line segments from A to P, from A to Q and from A to R?
- What is the point P that represents 25%, Q that represents 50% and R that represents 75% of the line segment AB called?

By discussion,

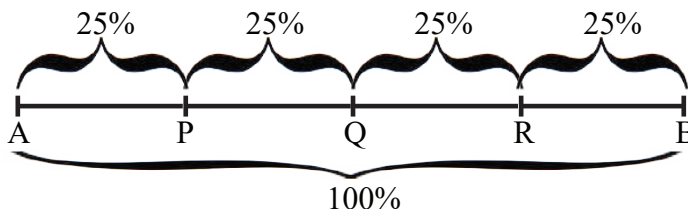

- To divide the line AB into 4 equal parts, we should break in 3 points. The three points are P, Q and R respectively.
- If AB is 100%, then
 $AP = 25\%$, $PQ = 25\%$, $QR = 25\%$, $RB = 25\%$
- Out of 100% of AB, the maximum 25% represents the point P, the maximum 50% represents the point Q and the maximum 75% represents the point R.
- Thus in line AB, the maximum 25% represents the point P, the maximum 50% represents the point Q and the maximum 75% represents the point R. This concept is clearly shown in the following figure:

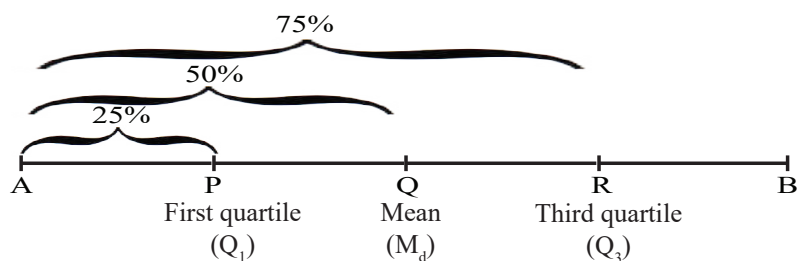

Activity 2

Study the given data and find the solution of the following questions:

40, 48, 37, 35, 46, 45, 47

- Arrange the given data in ascending order.
- Which value is contained in 25% and 75%?
- If we convert 25% and 75%, what may be the fraction?
- Add 1 to the total number of items and then write the fraction of 25% and 75%; and multiply by it. Then you can find the position of Q_1 and Q_3 . Write the value of Q_1 and Q_3 .

By discussion

- The least value of the data is 35, so arrange the data in ascending order from the 35.

35, 37, 40, 45, 46, 47, 48 x'G5 .

- 35, $\textcircled{37}$, 40, $\textcircled{45}$, 46, $\textcircled{37}$, 48
 Q_1 M_d Q_3

- $25\% = \frac{25}{100} = \frac{1 \times 25}{4 \times 25} = \frac{1}{4} = 1 \text{ part out of 4 parts and}$

$$75\% = \frac{75}{100} = \frac{3 \times 25}{4 \times 25} = \frac{3}{4} = 3 \text{ parts out of 4 parts}$$

- There are 7 items in the given data.

$$Q_1 \text{ lies in the position} = \frac{1}{4}(N + 1)^{\text{th}} \text{ item} = \frac{1}{4}(7 + 1)^{\text{th}} \text{ item} = \frac{1}{4} 8^{\text{th}} \text{ item} = 2^{\text{nd}} \text{ item}$$

$$Q_1 = 2^{\text{nd}} \text{ item} = 37$$

$$Q_3 \text{ lies in the position} = \frac{3}{4}(N + 1)^{\text{th}} \text{ item} = \frac{3}{4}(7 + 1)^{\text{th}} \text{ item} = \frac{3}{4} 8^{\text{th}} \text{ item} = 6^{\text{th}} \text{ item}$$

$$Q_3 = 6^{\text{th}} \text{ item} = 47$$

$$\therefore Q_1 = 37$$

$$Q_3 = 47$$

Activity 3

Study the given data and answer the following questions:

Weight (Kg)	20	22	24	27	28	30	31
Frequency	6	8	9	7	5	5	3

Rearrange the data in ascending order if necessary.

- Represent the data in cumulative frequency.
- Find the position that lie the first and third quartiles.
- Find the first and third quartiles from the cumulative frequency data.

From discussion,

- Construction of cumulative frequency table:

Weight (Kg)	Frequency (f)	Cumulative frequency (cf)
20	6	6
22	8	14
24	9	23
27	7	30
28	5	35
30	5	40
31	3	43
	Total number (N) = 43	

- From the cumulative frequency table:

$$Q_1 \text{ lies in the position} = \frac{1}{4} (N + 1)^{\text{th}} \text{ item}$$

$$= \frac{1}{4} \times (43 + 1)^{\text{th}} \text{ item}$$

$$= 11^{\text{th}} \text{ item}$$

$$\therefore Q_1 = 11^{\text{nd}} \text{ item} = 22$$

$$Q_3 \text{ lies in the position} = \frac{3}{4} (N + 1)^{\text{th}} \text{ item}$$

$$= \frac{3}{4} (43 + 1)^{\text{th}} \text{ item}$$

$$= 33^{\text{rd}} \text{ item}$$

$$\therefore Q_3 = 33^{\text{rd}} \text{ item} = 28$$

$$\text{Thus, } Q_1 = 22$$

$$Q_3 = 28$$

The three values which divide the whole data into four equal parts is called quartiles. The first quartile, second quartile and third quartile are denoted by Q_1 , Q_2 and Q_3 respectively. The points Q_1 and Q_3 divide the whole data into 25% and 75% respectively.

Here, Q_2 divides the whole data into 50%, so it is called the median.

Example 1

Find Q_1 and Q_3 from the following data.

57, 59, 52, 54, 51, 53, 55

Solution

Rearrange the data in ascending order as:

51, 52, 53, 54, 55, 57, 59

Here, total number of items $(N) = 7$

$$Q_1 \text{ lies in the position} = \frac{1}{4}(N + 1)^{\text{th}} \text{ item} = \frac{1}{4}(7 + 1)^{\text{th}} \text{ item} = \frac{1}{4} 8^{\text{th}} \text{ item} = 2^{\text{nd}} \text{ item}$$

$$Q_1 \text{ lies in the position} = 2^{\text{nd}} \text{ position} = 52$$

$$Q_3 \text{ lies in the position} = \frac{3}{4} (N + 1)^{\text{th}} \text{ item} = \frac{3}{4} (7 + 1)^{\text{th}} \text{ item} = \frac{3}{4} 8^{\text{th}} \text{ item} = 6^{\text{th}} \text{ item}$$

$$Q_3 \text{ lies in the position} = 6^{\text{th}} \text{ item} = 57$$

$$\therefore Q_1 = 52$$

$$Q_3 = 57$$

Example 2

Find first quartile Q_1 and third quartile Q_3 from the following data.

Marks	10	20	30	40	50	60	70
No. of Students	12	32	50	85	45	30	5

Solution

Now, construct the cumulative frequency table of the given data.

Marks	Frequency (f)	Cumulative frequency (cf)
10	6	6
20	4	10
30	2	12
40	1	13
50	5	18
60	8	26
70	9	35
	Total number (N) = 35	

There are 35 items in the given data, i. e. $N = 35$

$$Q_1 \text{ lies in the position} = \frac{1}{4}(N + 1)^{\text{th}} \text{ item} = \frac{1}{4}(35 + 1)^{\text{th}} \text{ item} = \frac{1}{4} 36^{\text{th}} \text{ item} = 9^{\text{th}} \text{ item}$$

$$Q_1 \text{ lies in the position} = \text{Value of } 9^{\text{th}} \text{ term} = 20$$

$$Q_3 \text{ lies in the position} = \frac{3}{4}(N + 1)^{\text{th}} \text{ item} = \frac{3}{4}(35 + 1)^{\text{th}} \text{ item} = \frac{3}{4} 36^{\text{th}} \text{ item} = 27^{\text{th}} \text{ item}$$

$$\therefore Q_3 = 27^{\text{th}} \text{ item} = 70$$

$$\text{Thus, } Q_1 = 20$$

$$Q_3 = 70$$

Example 3

Find the first quartile Q_1 and third quartile Q_3 from the following data.

Marks	12	13	14	15	16	17	18
No. of Students	6	8	9	3	3	5	4

Solution

Now, construct the cumulative frequency table of the given data.

Marks	Number of students (f)	Cumulative frequency (cf)
12	6	6
13	8	14
14	9	23
15	3	26
16	3	29
17	5	34
18	4	38
	Total number (N) = 38	

There are 38 items in the given data, i. e. $N = 38$

$$Q_1 \text{ lies in the position} = \frac{1}{4}(N + 1)^{\text{th}} \text{ item} = \frac{1}{4}(38 + 1)^{\text{th}} \text{ item} = \frac{1}{4} 39^{\text{th}} \text{ item} = 9.75^{\text{th}} \text{ item}$$

$$\begin{aligned} Q_1 &= \text{lies in the position} + 0.75 (10^{\text{th}} \text{ item} - 9^{\text{th}} \text{ item}) \\ &= 13 + 0.75 (13 - 13) \\ &= 13 \end{aligned}$$

$$Q_3 \text{ lies in the position} = \frac{3}{4} (38 + 1)^{\text{th}} \text{ item} = \frac{3}{4} (38 + 1)^{\text{th}} \text{ item} = \frac{3}{4} 39^{\text{th}} \text{ item} = 29.25^{\text{th}} \text{ item}$$

$$\begin{aligned} Q_3 &= 29^{\text{th}} \text{ item} + 0.25 (30^{\text{th}} \text{ item} - 29^{\text{th}} \text{ item}) \\ &= 16 + 0.25 (17 - 16) \\ &= 16 + 0.25 \\ &= 16.25 \end{aligned}$$

Exercise 18.2

1. Find the first quartile and third quartile from the following data:

- (a) 20, 40, 30, 15, 60, 90, 80
- (b) Rs. 400, Rs. 600, Rs. 350, Rs. 200, Rs. 550, Rs. 700, Rs. 320, Rs. 625, Rs. 370, Rs. 650, Rs. 275
- (c) 20, 15, 5, 10, 25
- (d) 15 kg, 9 kg, 12 kg, 24 kg, 18 kg, 21 kg
- (e) 18 °C, 28 °C, 26 °C, 16°C, 21°C, 29 °C, 25 °C, 12 °C, 23 °C

2. Find the first quartile (Q_1) and third quartile (Q_3) from the following data:

(a)

Marks	5	10	15	20	25	30
No. of Students	3	5	8	7	4	3

(b)

Wages	300	250	350	450	550
Number of labors	2	6	9	10	1

(c)

Weight (Kg)	105	115	125	135	145	155
Frequency	8	10	7	12	7	6

(d)

X	16	12	20	14	18
f	7	3	6	8	4

3. The mathematics marks with full marks 30 of 19 students studying in 9 class are as follows:

15, 10, 25, 10, 20, 15, 20, 25, 15, 20, 10, 20, 25, 15, 30, 20, 20, 30, 25

Convert the given data into discrete data and find the first quartile and third quartile

4. In the survey of class 10 students, the weight (Kg) of 45 students are as follows:

25, 40, 35, 35, 29, 40, 38, 25, 29, 27, 29, 27, 35, 40, 35, 29, 35, 38, 27, 29, 29, 40, 35, 35, 38, 29, 40, 27, 29, 35, 38, 27, 27, 29, 29, 25, 40, 27, 38, 25, 35, 25, 35, 29, 29

Find the lower and upper quartile of the given data.

5. Find the first quartile and third quartile from the following data:

- (a) 47, 49, 52, 54, 51, 53, 55
- (b) 7, 9, 6, 5, 7, 6, 4, 10, 9
- (c) 5, 10, 15, 20, 25
- (d) 64, 60, 70, 72, 68, 80, 85, 56

6. Find the first quartile (Q_1) and third quartile (Q_3) from the following data:

(a)	Marks	60	70	80	85	90	95	98
	No. of Students	5	7	12	15	18	3	2

(b)	Weekly income (Rs.)	300	400	500	600	700	800	900
	Number of labors	40	20	15	17	25	10	5

(c)	Height (cm)	120	121	122	123	124	125	126
	Number of students	5	10	12	17	16	3	4

(d)	Average temperature ($^{\circ}\text{C}$)	20	22	25	26	27	29
	Day	4	6	8	5	3	4

Project work

Divide the students in a suitable group and collect the marks of own class and preceding class. Then find the mean, median, mode, first quartile and third quartile of the collected data subject wise.

Answer

- | | |
|------------------------------|--------------------------------|
| 1. (a) $Q_1 = 20, Q_3 = 80$ | (b) $Q_1 = 320, Q_3 = 625$ |
| (c) $Q_1 = 7.5, Q_3 = 22.5$ | (d) $Q_1 = 11.25, Q_3 = 21.75$ |
| (e) $Q_1 = 17, Q_3 = 27$ | |
| 2. (a) $Q_1 = 10, Q_3 = 25$ | (b) $Q_1 = 300, Q_3 = 450$ |
| (c) $Q_1 = 115, Q_3 = 137.5$ | (d) $Q_1 = 14, Q_3 = 18$ |
| 3. $Q_1 = 15, Q_3 = 25$ | |
| 4. $Q_1 = 27, Q_3 = 38$ | |
| 5. (a) $Q_1 = 49, Q_3 = 54$ | (b) $Q_1 = 5.25, Q_3 = 8.5$ |
| (c) $Q_1 = 7.5, Q_3 = 22.5$ | (d) $Q_1 = 61, Q_3 = 78$ |
| 6. (a) $Q_1 = 80, Q_3 = 90$ | (b) $Q_1 = 300, Q_3 = 700$ |
| (c) $Q_1 = 122, Q_3 = 124$ | (d) $Q_1 = 22, Q_3 = 26$ |

19.0 Review

Study the following statements:

- (a) Today is cloudy, perhaps it rains.
- (b) I am in confusion of passing the exam.
- (c) The political situation may drastically change.
- (d) There is a equal chance of winning the election by two candidates.
- (e) What is the probability of winning the football 2022 by the Spain?

There are some words in the above statements like: perhaps, confusion, chance, probability that indicate uncertainty. That is, the result may happen or not. We can predict the result based on the past experiences and events. From the ancient period, people have been predicting such type of daily life events.

19.1 Probability

Estimation is the unpredictable fortune and probability. Thus, the measurement of uncertainty is called the probability. From the above statements: today is cloudy means it may rain. In this situation, it is better to take an umbrella. Here, raining is only the estimation i.e, there is no certainty of raining. Thus, the cloudy day is only the sign of raining.

Some technical terms of probability**Activity 1**

What may occur in tossing a coin and throwing a dice?



In tossing a coin, either a head (H) or tail (T) can occur.

The total number of possible occurrence in the case of tossing a coin can be given in the form of set is as: $S = \{H, T\}$.

Similarly in throwing a dice, the possible occurrence is: 1, 2, 3, 4, 5 or 6. That is, it can be written in the form of set as: $S = \{1, 2, 3, 4, 5, 6\}$.

Study the following technical terms based on the above examples.

(a) Experiment

The result or outcomes that cannot be predicted is called the experiment. In above example, we cannot predict the turning of H or T. Thus, the tossing a coin is an experiment.

(b) Random experiment

An experiment whose outcomes cannot be predicted with certainty is called random experiment. For example: we cannot say who can win the prize from a lottery. That is, nobody can predict the result of the lottery. Thus, drawing a lottery is a random experiment. Similarly from the above example: tossing a coin, rolling a die, etc are the example of random experiment.

(c) Outcomes

The results of random experiment are called outcomes or events. For example: in tossing a coin, any one out of H or T will turn. Then, it is a outcome of the experiment.

(d) Equally likely outcomes

An experiment in which the chance of occurring any one of the event is equal to the chance of occurring the other event is called equally likely events.

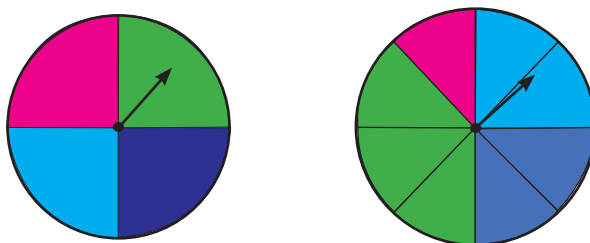

In the above first figure, there is an equal chance of indicating the needle to the four color on rotating the spinner because all four color covers the equal area. Thus, the result of indicating the four color: red, green, yellow and blue are the cases of equally likely outcomes.

Again in second figure, if we rotate the spinne, there is no equal chance of indicating the four colors because all four colors do not cover the equal area. There is not equal chance of indicating the four colors: red, green, yellow and blue and thus the second figure does not show the equally likely outcomes.

(e) Sample space

The set of all possible outcomes of a random experiment is called as sample space. Generally, it is denoted by S.

The sample space in the case of tossing a coin $(S) = \{H, T\}$ and $n(S) = 2$.

The sample space in the case of rolling a dice $(S) = \{1, 2, 3, 4, 5, 6\}$ and $n(S) = 6$

(f) Event

The set of outcomes of any experiment is called an event. It is denoted by E.

In the case of tossing a coin, the result may be $S = \{H, T\}$ then the possible cases: not turning both, turning head, turning tail, etc. are the events. Thus, $\{\}, \{H\}, \{T\}, \{H, T\}$ are all the events in tossing a coin.

(g) Mutually exclusive events

In tossing a coin, record the turning face. In the first tossing, the turn face may be a T. Could we see the face H in this case? If we toss the coin again, then we found the face H. Could we see the face T in this case?

In this way, the experiment in which any one of the event can occur but another event cannot occur simultaneously, then such types of event is called mutually exclusive event. For example: in tossing a coin, out of H or T, only one can occur, but not both the H and T can occur simultaneously. Thus, turning H and T are the mutually exclusive events in the case of tossing coin.

Now, discuss in your class whether the turning faces from 1 to 6 are mutually exclusive events or not in the case of rolling a dice.

(h) Number of favourable outcomes

The outcomes of random experiment, which entails the happening of an event, are known as the number of favorable outcomes.

(i) Elementary event

The set of all possible outcomes in an experiment is called elementary event. For example: if we roll a dice, then the elementary events are: $\{1, 2, 3, 4, 5, 6\}$.

Activity 2

In tossing a coin,

What is the probability of getting a head (H)?

What is the probability of getting a tail (T)?

What are the total possible outcomes in tossing a coin?

Here, in tossing a coin the total possible outcomes in tossing a coin are: $S = \{H, T\}$

Thus, total number of sample space: $n(S) = 2$

Occurring the event of head: $(E) = \{H\}$

Thus, number of favorable outcomes: $n(E) = 1$

The probability of any event: $P(E) = \frac{n(E)}{n(S)} = \frac{\text{The probability of}}{\text{Total number of sample space}}$

Thus, the probability of getting head = $\frac{1}{2}$

Example 1

What is the probability of getting even numbers in throwing a dice?

Solution

In throwing a dice,

The sample space (S) = {1, 2, 3, 4, 5, 6}

Thus, the total number of sample space: $n(S) = 6$

Favorable cases (E) = Even numbers = {2, 4, 6}

Thus, the number of favorable cases $n(E) = 3$

Probability of occurring the even number $P(E) = ?$

Now $P(E) = \frac{n(E)}{n(S)} = \frac{3}{6} = \frac{1}{2} = 0.5$

Example 2

The result of 80 students in an exam is given below:

Grade	A ⁺	A	B ⁺	B
Number of Students	12	20	18	30

Find the probability of the following if a student is selected randomly.

- (a) Securing A grade
- (b) Securing B grade

Solution

Here, total number of students: $n(S) = 80$

Number of students securing A grade: $n(A) = 12$

Number of students securing B grade: $n(B) = 30$

(a) Probability of securing A grade: $p(A) = ?$

$$\text{Now, } p(A) = \frac{n(A)}{n(S)} = \frac{12}{80} = \frac{3}{20}$$

Thus, the probability of securing A grade = $\frac{3}{20}$

(b) Probability of securing B grade: $p(B) = ?$

$$\text{Now, } p(B) = \frac{n(B)}{n(S)} = \frac{30}{80} = \frac{3 \times 10}{8 \times 10} = \frac{3}{8}$$

Thus, the probability of securing B grade: $P(B) = \frac{3}{8}$

Example 3

What is the probability of not selecting a square number in selecting number cards labeled from 1 to 10?

Solution

In selecting a number cards,

The sample space (S) = {1, 2, 3, 4, 5, 6, 7, 8, 9, 10}

Thus, the total number of sample space: $n(S) = 10$

Favorable cases (E) = Square numbers = {1, 4, 9}

Thus, the number of favorable cases: $n(E) = 3$

Probability of occurring the square number: $P(E) = ?$

$$\text{Now, } P(E) = \frac{n(E)}{n(S)} = \frac{3}{10}$$

Then, the probability of not occurring square number: $P(\bar{E}) = 1 - P(E)$
 $= 1 - \frac{3}{10} = \frac{7}{10}$

Thus, the probability of not occurring square number: $= \frac{7}{10}$

Alternate method

Number of sample space $n(s) = 10$

Non squared number $n(\bar{E}) = \{2, 3, 5, 6, 7, 8, 10\} = 7$

The number of non squared number $n(\bar{E}) = 7$

The probability of non squared number $P(\bar{E}) = ?$

$$\text{Now, } P(\bar{E}) = \frac{n(\bar{E})}{n(S)}$$

Therefore, the probability of non-squared number is $P(\bar{E}) = \frac{7}{10}$

Exercise 19.1

1. Find the sample space of the following experiment:

- (a) Roll a dice in one time
- (b) Tossing a coin in two times
- (c) Selecting a day from in a week
- (d) Indicating a color in spinning a spinner

2. Write down the events/favorable cases from the following condition:

- (a) Getting even numbers in rolling a dice in one time
- (b) Getting two head in tossing a coins in two times
- (c) Turning odd day in selecting a day from a week numbered from 1 to 7.
- (d) Turning a head and a tail in tossing two coins in one times

3. Find the probability of getting prime number in rolling a dice.

4. Find the probability of one head and one tail in one time tossing two coins.





5. Find the probability of the following based on the given table.

Number of children	0	1	2	3
Total number of family	9	15	36	30

- (a) Probability of getting 0 children family
- (b) Probability of getting 2 children family
- (c) Probability of getting at least 2 children family

6. Divide the class into four groups. Take a pack of well-shuffled deck of 52 cards by each group. Fill the number of Red, Black, Heart, Diamond, Spade, Club, Face cards, Jack, Queen, King, Ace cards in the following table.

(a)

(b)

A	J	Q	K

(c)

Red	Black	Face card

- (d) Find the probability of the following based on the above table:
- (i) Spade (ii) Ace (A) (iii) Red card
 (iv) Black king (v) Jack and Queen (vi) Not the king

Answer

1. (a) {1, 2, 3, 4, 5, 6} (b) {HH, HT, TH, TT}
 (c) {Sunday, Monday, Tuesday, Wednesday, Thursday, Friday, Saturday}
 (d) {Red, Green, Blue, Yello}
2. (a) {2, 4, 6} (b) {HH} (c) {1, 3, 5, 7} (d) {HT, TH}
3. $\frac{1}{2}$ 4. $\frac{1}{2}$ 5. (a) $\frac{1}{10}$ (b) $\frac{2}{5}$ (c) $\frac{11}{15}$
6. Show the answers to the teacher

19.2 Probability scale

Activity 1

Write the sample space in the case of tossing a coin. Similarly, write the possible outcomes in tossing a coin.

$$S = \{H, T\}, \{H\}, \{T\}$$

Find the probability of each of the above cases.

$$P(A) = \dots\dots,$$

$$P(B) = \dots\dots,$$



$$\frac{1}{2}$$



$$\frac{1}{2}$$

Add all the probability after finding the probability.

$$P(H) = \dots\dots\dots \text{ or, } P(T) = \dots\dots\dots$$

$$P(H) + P(T) = \dots\dots\dots$$

Similarly, what is the probability of not occurring H and T?

Showing the above probability in number line as:

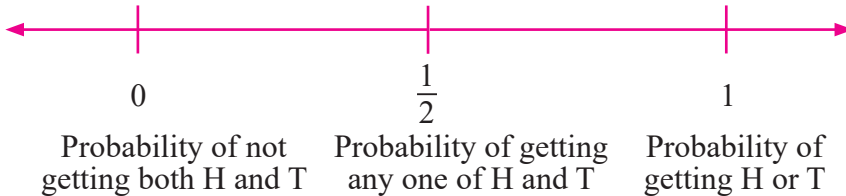

We can conclude as following based on the above number line

$$\text{Probability of getting H or T: } P(H) = P(T) = \frac{1}{2}$$

$$\text{Probability of getting in tossing a coin H or T: } P(H \text{ or } T) = \frac{1}{2} + \frac{1}{2} = \frac{2}{2} = 1$$

$$P(S) = 1 \text{ where } S = \{H, T\}$$

The least value of probability is 0, it means that the probability of occurring the event is completely impossible. And the highest value of probability is 1 that means the probability of occurring the event is certain. In this way, the probability of getting any event E lies between 0 and 1, i. e., $0 \leq P(E) \leq 1$. It is called a probability scale.

Activity 2

Put a red, two green and three white same size tennis ball in a box. Draw a ball randomly by a student. Then, write down the possible probability in the blackboard.

Let us assume that: Red = R, Green = G and White = W.

- (a) Find the separate probability of getting these three different color.

$$P(R) = \dots\dots\dots, \quad P(G) = \dots\dots\dots, \quad P(W) = \dots\dots\dots$$

- (b) Adding all the probability.

$$P(R) + P(G) + P(W) = \dots\dots\dots = \dots\dots\dots$$

Example 1

Find the probability of indicating the blue color and not indicating the blue color in the case of turning a spinner having three different color: blue, yellow and red.



Solution

Here, there are three different colors: blue, yellow and red in a spinner.

∴ Total number of sample space cases: $n(S) = 3$

Number of blue color part = Number of favorable cases $n(E) = 1$

∴ The probability of indicating the blue color part: $P(E) = \frac{n(A)}{n(S)} = \frac{1}{3}$

Again, the probability of not indicating the blue color part: $P(\bar{E}) = 1 - P(E)$

$$\begin{aligned} &= 1 - \frac{1}{3} \\ &= \frac{3-1}{3} \\ &= \frac{2}{3} \end{aligned}$$

Example 2

What is the probability of drawing a king from a well shuffled deck of 52 cards?

Solution

Here in the case of drawing a card from a well shuffled deck of 52 cards,

Total number of sample space cases: $n(S) = 52$

The number of favorable cases = Number of king: $n(K) = 4$

Now, the probability of king $P(K) = ?$

The probability of indicating the blue color part: $P(K) = \frac{n(K)}{n(S)} = \frac{4}{52}$

$$\therefore P(K) = \frac{1}{13}$$

Example 3

What is the probability of not getting 5 in throwing a dice?

Solution

Here in the case of throwing a dice $(S) = \{1, 2, 3, 4, 5, 6\}$

Total number of sample space cases: $n(S) = 6$

The number of favorable cases = Number of 5: $n(5) = 1$

Now, the probability of king $P(5) = ?$

$$\begin{aligned} \therefore \text{The probability of getting 5: } P(E) &= \frac{n(E)}{n(S)} \\ &= \frac{1}{6} \end{aligned}$$

Again, the probability of not getting 5: $P(\bar{E}) = 1 - P(E)$

$$\begin{aligned} &= 1 - \frac{1}{6} \\ &= \frac{6-1}{6} \\ &= \frac{5}{6} \end{aligned}$$

\therefore The probability of not getting 5 in throwing a dice = $\frac{5}{6}$

Example 4

There are 2 red, 3 black and 4 green marbles in a bag. If 1 marble is drawn randomly, then find the probability of the following:

- (i) getting red marble
- (ii) getting green marble
- (iii) not getting red marble

Solution

There are 2 red, 3 black and 4 green marbles in a bag.

Total number of sample space cases: $n(S) = 2 + 3 + 4 = 9$

- (i) The number of red balls: $n(R) = 2$
 \therefore The probability of getting red ball: $P(R) = \frac{n(R)}{n(S)} = \frac{2}{9}$
- (ii) The number of green balls: $n(G) = 4$
 \therefore The probability of getting green ball: $P(R) = \frac{n(G)}{n(S)} = \frac{4}{9}$
- (iii) The number of black balls: $n(B) = 3$
Now, the probability of getting black ball: $P(B) = \frac{n(B)}{n(S)} = \frac{3}{9} = \frac{1}{3}$
 \therefore The probability of not getting black ball: $P(\bar{B}) = 1 - \frac{1}{3} = \frac{3-1}{3} = \frac{2}{3}$

Exercise 19.2

1. Show the result in a probability scale (0 – 1) in the case of tossing a coin.
2. **There are 2 blue, 3 black and 5 red marbles in a bag. If one marble is drawn randomly, then find the probability of the following:**
 - (a) getting black marble
 - (b) not getting black marble
 - (c) Show the result in a probability scale (0 – 1) in the case of (a) and (b).
3. What is the probability of getting public holiday in Sunday throughout of the year? Similarly, find the probability of not getting public holiday in Sunday.
4. **In the case of drawing a card from a well shuffled deck of 52 cards,**
 - (a) What is the probability of getting red card?
 - (b) What is the probability of getting red or black card?
 - (c) Show the result in a probability scale (0 – 1) of the above two probability.

5. Find the probability of indicating the following colours in the case of turning the spinner, and show the result in a probability scale (0 – 1).

- (a) indicating the white color
- (b) indicating the yellow color
- (c) indicating the yellow or red color
- (d) indicating the yellow or red or green color
- (e) indicating the yellow or red or green or blue color
- (f) show the result in a probability scale (0 – 1) of all the above

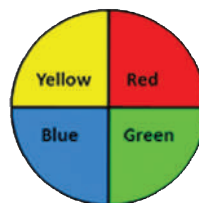

6. Show the result in a probability scale (0 – 1) in the case of throwing a dice having 6 faces.

7. If a number card numbered from 2 to 25 is drawn randomly, then

- (a) What is the probability of getting a number card, which is exactly divisible by 3?
- (b) What is the probability of getting even number cards?

Answer

1. Show the answer to your teacher.
2. (a) $\frac{3}{10}$ (b) $\frac{7}{10}$
- (c) Show the answer to your teacher.
3. $\frac{52}{365}, \frac{313}{365}$
4. (a) $\frac{1}{2}$ (b) 1 (c) Show the answer to your teacher.
5. (a) 0 (b) $\frac{1}{4}$ (c) $\frac{1}{2}$ (d) $\frac{3}{4}$ (e) 1
6. Show the answer to your teacher.
7. (a) $\frac{1}{3}$ (b) $\frac{1}{2}$

19.3 Empirical probability

Activity 1

- (a) If a dice is thrown 10 times, 15 times, 20 times respectively, observe the fraction of turning 1, 2, 3, 4, 5 and 6 to the total number of throwing the ball.

We know that, if a coin is tossed, then the probability of turning head is $\frac{1}{2}$.

That is, $P(H) = \frac{1}{2}$ and $P(\bar{H}) = P(T) = 1 - \frac{1}{2} = \frac{1}{2}$. Based on this theory, if we turn a coin 10 or 20, then the probability of head is $10 \times \frac{1}{2} = 5$ or, $20 \times \frac{1}{2} = 10$. But in practice, the result of the experiment may differ. In this way, the probability obtained from a practice or experiment is called empirical probability. Similarly, the process of obtaining the probability through practical base is called empirical probability. The following formula is used for finding the empirical probability.

$$\text{Empirical Probability} = \frac{\text{Number of outcomes through experimen}}{\text{Total number of experiment}}$$

Example 1

The following result is obtained in throwing a coin 50 times:

Experiment (E)	Head (H)	Tail (T)
Frequency (f)	23	27

What is the empirical probability of getting head?

Solution

Here, the empirical probability of head: $P(H) = \frac{23}{50}$ and $P(T) = \frac{27}{50}$

Example 2

If 2000 bricks were unloaded from a mini truck, the probability of breaking the bricks is 0.1, and then what is the number of unbroken bricks?

Solution:

Here, the number of bricks: $N(S) = 2000$

Probability of breaking the bricks: $P(E) = 0.1$

Probability of unbroken bricks: $p(\bar{E}) = 1 - 0.1 = 0.9$

$$\begin{aligned}\therefore \text{The number of unbroken bricks:} &= n(S) \times p(\bar{E}) \\ &= 2,000 \times 0.9 \\ &= 1,800\end{aligned}$$

Exercise 19.3

- There are 50 students in a class out of which 28 are girls. If a student is selected randomly, then what is the probability of girl student to be selected in essay competition?
- Among 35 students of class 9, 25 students can fluently speak and write English language. If a student is selected randomly, then what is the probability of selecting a student who can fluently speak and write English language in a quiz competition?
- Toss three coins simultaneously, and then answer the following questions based on the result.**
 - What is the probability of turning all heads?
 - What is the probability of turning a head and two tails?
 - What is the probability of turning two heads and a tail?
 - What is the probability of turning all tails?
- Write the sample space in rolling a dice and find the following probability:**
 - turning 5 face
 - turning even number face
 - turning odd number face

5. The following tables shows the result of throwing a dice 60 times:

Event (E)	1	2	3	4	5	6
Frequency (f)	8	9	13	15	11	4

Find the following empirical probability:

- (a) turning 4
 - (b) turning more than 5
 - (c) turning less than 3
 - (d) turning the sum of 7
6. 58 baby girls out of 100 children were born in a hospital. Then, find the empirical probability of borning baby boy.

Project work

Work in pairs and do the following task:

- (a) Put number balls numbered from 1 to 9 in a pot like as a given figure.
- (b) Draw a ball one by one respectively and replace it; and shake well
- (c) Repeat the above task in 100 times.
- (d) Complete the following table using tally bar from the above result.



Number
Tally bar									
Frequency									

- (e) Find the probability of turning 1 to 9 and present the result in your class.

Answer

- 1. $\frac{14}{25}$
- 2. $\frac{5}{7}$
- 3 - 4. Show the answers to your teacher
- 5. (a) $\frac{1}{4}$
- (b) $\frac{1}{15}$
- (c) $\frac{17}{60}$
- (d) $\frac{21}{50}$

1. **Construct a continuous data having 10/10 class interval of the following raw data:**

50, 20, 65, 52, 41, 42, 70, 27, 59, 50, 39, 43, 33, 63, 60, 47, 44, 64, 32, 51, 57, 18, 55, 38, 54, 22, 31, 68, 26, 24, 37, 40, 66, 28, 35, 14, 43, 36, 34, 12

Now, from the table

- (a) Draw histogram.
 (b) Draw frequency polygon.
 (c) Sketch less than and more than cumulative frequency ogive in the same graph.
2. **Construct a frequency table having 5/5 class interval of the following raw data:**

45, 20, 23, 49, 47, 27, 29, 30, 32, 25, 34, 47, 45, 33, 33, 32, 37, 44, 42, 31, 42, 40, 35, 39, 26, 35, 27, 38, 34, 37

From the frequency table,

- (a) Draw histogram.
 (b) Draw frequency polygon.
 (c) Sketch less than and more than cumulative frequency ogive in the same graph.
3. **Answer the following questions:**

- (a) Write any 5 data having median 15.
 (b) Write any 5 data having both mean and median 15.

4. **Find the arithmetic mean, median, mode, first quartile (Q_1) and third quartile (Q_3) from the following data:**

(a)

X	35	40	45	50	55	60	65
f	2	9	10	9	6	3	1

(b)

Age (Yrs)	5	15	25	35	45	55
Number of persons	8	10	12	18	12	4

(c)

Cost (Rs.)	50	60	75	85	90	92
Number of shops	10	4	6	8	7	5

(d) Marks	5	10	15	20	25	30
Number of students	7	6	8	4	5	10

5. A fair dice having 6 faces is rolled 56 times and found the following result:

1, 6, 5, 6, 4, 3, 4, 4, 3, 5, 1, 1, 6, 6, 5, 4, 3, 2, 2, 2, 6, 5, 1, 4, 3,
1, 5, 4, 6, 4, 3, 2, 2, 3, 1, 1, 1, 1, 6, 6, 2, 1, 3, 6, 4, 1, 5, 6, 6, 1,
3, 5, 5, 4, 6, 3

Present the above data into discrete data and find the following

- Find arithmetic mean.
- Determine the first quartile, second quartile and third quartile.
- Calculate mode and range.

Answer

1-3. Show the answers to your teacher.

4. (a)

$\bar{X} = 47.63$	$M_d = 45$	$M_o = 45$	$Q_1 = 40$	$Q_3 = 53.75$
-------------------	------------	------------	------------	---------------

(b)

$\bar{X} = 29.38$	$M_d = 35$	$M_o = 35$	$Q_1 = 15$	$Q_3 = 42.5$
-------------------	------------	------------	------------	--------------

(c)

$\bar{X} = 74$	$M_d = 80$	$M_o = 50$	$Q_1 = 52.5$	$Q_3 = 90$
----------------	------------	------------	--------------	------------

(d)

$\bar{X} = 18$	$M_d = 15$	$M_o = 30$	$Q_1 = 10$	$Q_3 = 28.75$
----------------	------------	------------	------------	---------------

5. (a) $\bar{X} = 3.55$ (b) $Q_1 = 2, M_d = 4, Q_3 = 5$ (c) $M_o = 1 / 6$

20.0 Review

Divide the students in suitable groups. Observe the given triangle $\triangle ABC$ and $\triangle PQR$; and measure all the sides and angles. Then, discuss within your group based on the following questions:

Which angles are equal?

Are the measurements of sides equal?

Are the $\triangle ABC$ and $\triangle PQR$ similar?

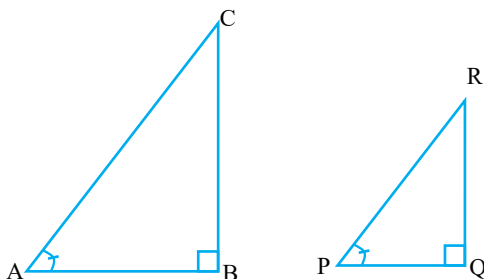

Find the ratios of the sides of triangle ABC $\frac{AB}{BC}$, $\frac{BC}{AC}$ and $\frac{AB}{AC}$

Find the ratios of the sides of triangle PQR: $\frac{PQ}{QR}$, $\frac{QR}{PR}$, and $\frac{PQ}{PR}$

Now, write the ratios of right angled triangles $\triangle ABC$ and $\triangle PQR$ based on perpendicular, base and hypotenuse.

20.1 Trigonometric ratios

Activity 1

Draw a acute angle $\angle AOB$ and name it as θ

Mark three points P, Q and R on line OB in a certain distance.

Draw perpendicular from points P, Q and R on OB using set square which meet at points X, Y and Z respectively of line OA.

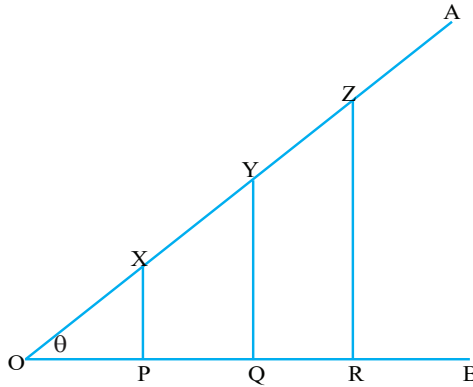

Now, measure the following parts and find the ratios of the following:

(a) $\frac{XP}{OX}$, $\frac{YQ}{OY}$ and $\frac{ZR}{OZ}$ (b) $\frac{OP}{OX}$, $\frac{OQ}{OY}$ and $\frac{OR}{OZ}$ (c) $\frac{XP}{OP}$, $\frac{YQ}{OQ}$ / $\frac{ZR}{OR}$

Discuss in your group and present the conclusion in the class.

The above ratios are the trigonometric ratios. Trigonometry studies the relationship between sides and angles. Trigonometry is used to find the height, length and angles of different unusual situations. It is impossible to develop and expand the mathematics, physics and engineering without trigonometrical ratios. Thus, trigonometry is the most important and indispensable contents of mathematics and science.

In the given right angled triangle ABC, $\angle ACB = \theta$ be a reference angle, AB = perpendicular (p), BC = base (b), AC = hypotenuse (h)

Now, in right angled triangle ABC,

$$\frac{AB}{AC} = \frac{p}{h} = \frac{\text{perpendicular}}{\text{hypotenuse}} = \frac{\text{opposite side}}{\text{hypotenuse}}$$

is called the

sine ratio of reference angle θ .

In short, it is written as $\sin \theta$.

$$\frac{AB}{BC} = \frac{b}{h} = \frac{\text{base}}{\text{hypotenuse}} = \frac{\text{adjacent side}}{\text{hypotenuse}}$$

is called the cosine ratio of reference angle θ .

In short, it is written as $\cos \theta$.

$$\frac{AB}{BC} = \frac{p}{b} = \frac{\text{perpendicular}}{\text{base}} = \frac{\text{opposite side}}{\text{adjacent side}}$$

is called the tangent ratio of reference

angle θ .

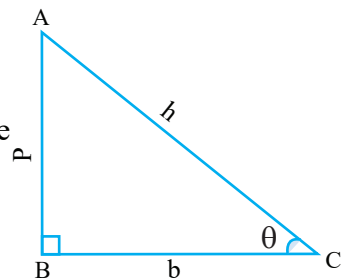

In short, it is written as $\tan \theta$.

In this way, the three ratios $\sin \theta = \frac{p}{h}$, $\cos \theta = \frac{b}{h}$, $\tan \theta = \frac{p}{b}$ are called the fundamental trigonometric ratios.

Write the opposite trigonometric ratios of the above ratios.

$$\frac{1}{\sin \theta} = \frac{h}{p} = \theta \text{ cosecant} = \text{cosec} \theta$$

$$\frac{1}{\cos \theta} = \frac{h}{b} = \theta \text{ secant} = \text{sec} \theta$$

$$\frac{1}{\tan \theta} = \frac{b}{p} = \theta \text{ cotangent} = \text{cot} \theta$$

Generally, angle is denoted by Greek letters. Some of them are as follows:

Letters	English name
α	Alpha
β	Beta
γ	Gamma
δ	Delta
θ	theta
ϕ	phi
π	pi
ψ	psi
λ	lambda

Example 1

Write the 6 trigonometric ratios from the given triangle.

Solution:

In right angled triangle XYZ, perpendicular (p) = 4 cm, base (b) = 3 cm and hypotenuse (h) = 5 cm.

Reference angle $\angle xyz = \alpha$

$$\sin \alpha = \frac{xy}{xz} = \frac{p}{h} = \frac{4}{5}$$

$$\cos \alpha = \frac{yz}{xz} = \frac{b}{h} = \frac{3}{5}$$

$$\text{cosec} \alpha = \frac{xz}{xy} = \frac{h}{p} = \frac{5}{4}$$

$$\text{sec} \alpha = \frac{xz}{yz} = \frac{h}{b} = \frac{5}{3}$$

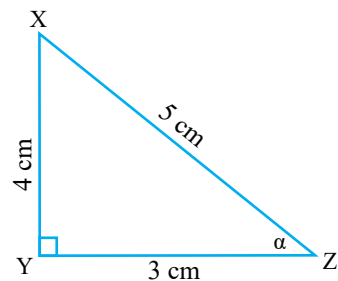

$$\tan \alpha = \frac{xy}{yz} = \frac{p}{b} = \frac{4}{3} \qquad \cot \alpha = \frac{yz}{xy} = \frac{3}{4}$$

Example 2

From the given right-angled triangles $\triangle CED$ and $\triangle ABC$, find the trigonometric ratios: \sin , \cos and \tan .

Solution:

In right angled triangle $\triangle CED$

$$\sin \theta = \frac{DE}{DC} = \frac{p}{h} = \frac{3}{5}$$

$$\cos \theta = \frac{EC}{DC} = \frac{b}{h} = \frac{4}{5}$$

$$\tan \theta = \frac{DE}{EC} = \frac{p}{b} = \frac{3}{4}$$

In right angled triangle $\triangle CED$

$$\sin \theta = \frac{AB}{AC} = \frac{p}{h} = \frac{6}{10} = \frac{3}{5}$$

$$\cos \theta = \frac{BC}{AC} = \frac{b}{h} = \frac{8}{10} = \frac{4}{5}$$

$$\tan \theta = \frac{AB}{BC} = \frac{p}{b} = \frac{6}{8} = \frac{3}{4}$$

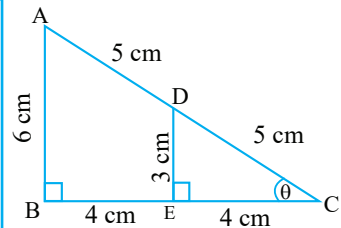

Activity 2

Draw a right angled triangle ABC.

Taking $\angle BCA = \theta$ as a reference angle, write a Pythagorean relation.

$$AB^2 + BC^2 = AC^2 \dots\dots\dots (i)$$

Dividing both sides by AC^2

$$\frac{AB^2}{AC^2} + \frac{BC^2}{AC^2} = \frac{AC^2}{AC^2}$$

$$\text{Or } \left(\frac{AB}{AC}\right)^2 + \left(\frac{BC}{AC}\right)^2 = \left(\frac{AC}{AC}\right)^2$$

$$\text{Or } \left(\frac{p}{h}\right)^2 + \left(\frac{b}{h}\right)^2 = 1$$

$$\text{or, } (\sin \theta)^2 + (\cos \theta)^2 = 1$$

$$\text{or, } \sin^2 \theta + \cos^2 \theta = 1$$

Similarly, divide the equation (i) by AB^2 and BC^2 .

Discuss the result in the class.

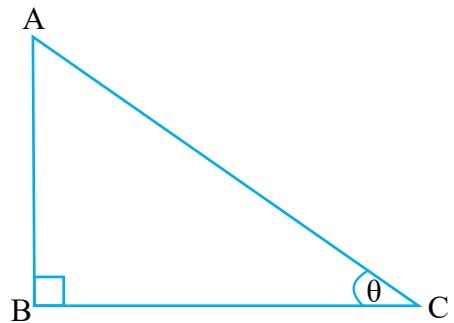

Example 3

In right angled triangle ABC, $\angle B = 90^\circ$, $\angle C = \theta$, AB = 12 cm, AC = 13 cm, then prove that $\sin^2\theta + \cos^2\theta = 1$

Solution

Here, perpendicular (AB) = $p = 12$ cm,
hypotenuse (AC) = $h = 13$ cm, base (BC) =
 $b = ?$

By Pythagoras theorem,

$$h^2 = p^2 + b^2$$

$$\text{or, } 13^2 = 12^2 + b^2$$

$$\text{or, } b^2 = 169 - 144 = 25 \text{ Thus, } b = 5$$

$$\text{Now, } \sin^2\theta + \cos^2\theta = \frac{p^2}{h^2} + \frac{b^2}{h^2} = \frac{(12)^2}{(13)^2} + \frac{(5)^2}{(13)^2} = \frac{169}{169} = 1$$

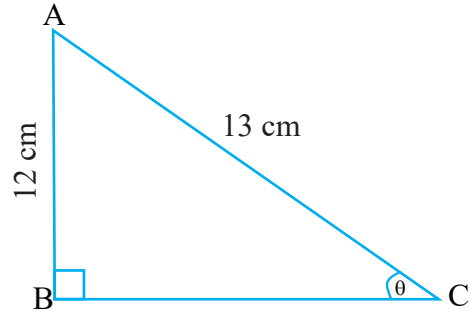

Exercise 20.1

1. In a right angled triangle ABC, answer the following questions as reference angle $\angle ACB = \phi$ and $\angle BAC = \beta$

- Determine the perpendicular, base and hypotenuse taking ϕ as a reference angle.
- Find the 6 trigonometric ratios taking ϕ as a reference angle.
- Determine the perpendicular, base and hypotenuse taking β as a reference angle.

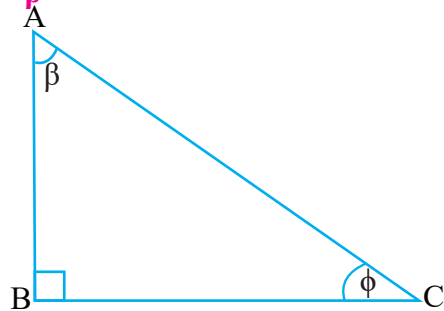

- Find the 6 trigonometric ratios taken α as a reference angle.

2. In right angled triangle PQR,

- Find the value of $\sin \beta$, $\cos \beta$ and $\tan \beta$.
- Find the value of $\operatorname{cosec} \beta$, $\sec \beta$ and $\cot \beta$.
- Find the value of $\sin \alpha$, $\cos \alpha$, $\tan \alpha$, $\operatorname{cosec} \alpha$, $\sec \alpha$ and $\cot \alpha$.

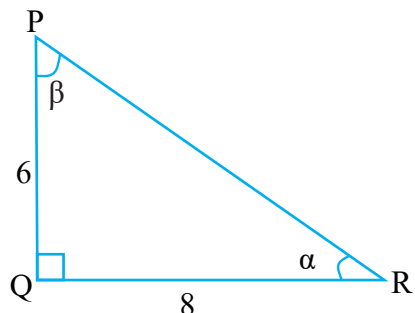

3. (a) If $\sin\theta = \frac{6}{10}$ and $h = 20$, then $b = ?$
 (b) If $\tan\theta = \frac{5}{12}$, then find the following
 (i) $h = ?$
 (ii) Find the value of $\sin\theta$ and $\cos\theta$.

4. **Determine the value of the following on the basis of trigonometric ratio:**

- (a) $\sin^2A + \cos^2A$ (b) $1 - \cos^2A$ (c) $\sin\theta \div \cos\theta$
 (d) $\tan^2\theta + 1$ (e) $\cos\theta \div \sin\theta$ (f) $\operatorname{cosec}^2\theta - \cot^2\theta$

5. **Prove that the following on the basis of trigonometric ratio:**

- (a) $\sin^2\theta + \cos^2\theta = 1$ (b) $1 - \sin^2\theta = \cos^2\theta$ (c) $\frac{\sin\theta}{\cos\theta} = \tan\theta$
 (d) $\sec^2\theta - 1 = \tan^2\theta$ (e) $\operatorname{cosec}^2\theta - \cot^2\theta = 1$

6. **A inclined plane having length 29 ft is constructed to carry out the particles to the 20 ft height building, then**

- (a) Find the distance between the tower and lower part of the inclined plane.
 (b) Find the value of $\tan\theta$, $\sin\theta$ and $\cos\theta$, if the angle made by the inclined plane with ground is θ .

7. **In the given figure, AC is a length from tree to the top of the lamp post AB, and BC is distance between the lamp post and the tree.**

- (a) If $BC = 24$ m, $AC = 40$ m, then find the height of the lamp post.
 (b) Find the value of $\tan\theta$, $\sin\theta$ and $\cos\theta$, if the $\angle ACB$ in the reference angle.

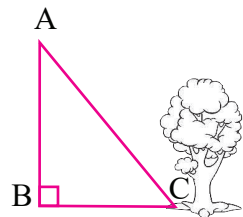

Answer

1 - 2. Show the answer to your teacher.

3. (a) 16 (b) (i) 13 (ii) $\frac{5}{13}, \frac{12}{13}$ (c) $\frac{15}{17}, \frac{8}{17}$

4. (a) 1 (b) $\sin^2 A$ (c) $\tan\theta$ (d) $\sec^2\theta$ (e) $\cot\theta$ (f) 1

5. Show the answer to your teacher. 6. (a) 21 ft (b) $\frac{20}{21}, \frac{20}{29}, \frac{21}{29}$

7. (a) 32 m (b) $\frac{4}{3}, \frac{4}{5}, \frac{3}{5}$

20.2 Trigonometric ratio of special angles

(a) 45° Trigonometric value of angle

As shown in the given figure, draw an angle $\angle AOB = \alpha = 45^\circ$. Measure the following parts of the given figure. $AB \perp OB$ and $PQ \perp OB$

$$OP = \dots\dots, OQ = \dots\dots, PQ = \dots\dots$$

$$OA = \dots\dots, OB = \dots\dots, AB = \dots\dots$$

Here, $\triangle OQP$ and $\triangle OBA$

Now, find separate value of $\sin 45^\circ$, $\cos 45^\circ$ and $\tan 45^\circ$ from triangles $\triangle OQP$ and $\triangle OBA$.

Comparing the different trigonometric ratios in both triangles.

$$\sin 45^\circ = \dots\dots$$

$$\cos 45^\circ = \dots\dots$$

$$\text{And } \tan 45^\circ = \dots\dots$$

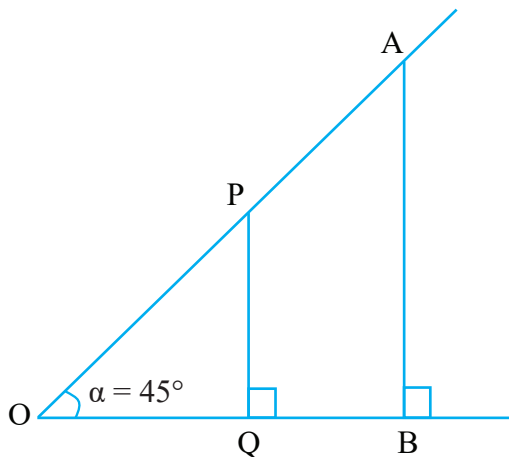

Here $\angle POQ = \angle AOB = 45^\circ$ x'G5 .

Thus, side $OQ = PQ = x$

Now, from Pythagoras theorem,

$$OP^2 = PQ^2 + OQ^2 = x^2 + x^2 = 2x^2$$

$$OP = \sqrt{2x^2}$$

In $\triangle OQP$

$$\sin \alpha = \sin 45^\circ = \frac{p}{h} = \frac{PQ}{OP} = \frac{x}{\sqrt{2x^2}} = \frac{1}{\sqrt{2}} = 0.707$$

$$\cos \alpha = \cos 45^\circ = \frac{b}{h} = \frac{OQ}{OP} = \frac{x}{\sqrt{2x^2}} = \frac{1}{\sqrt{2}} = 0.707$$

$$\tan \alpha = \tan 45^\circ = \frac{p}{b} = \frac{PQ}{OQ} = \frac{x}{x} = 1 = 1.000$$

Again, find the value of cosec 45° , sec 45° and cot 45° on the basis of above values.

(b) Trigonometric value of angle 30° and 60°

Draw an equilateral triangle ΔPQR to find the trigonometric values 30° and 60° where $\angle P = \angle Q = \angle R = 60^\circ$

Thus, sides $PQ = QR = PR = x$ (say)

For finding the values of trigonometric ratios, we need a right angled triangle. Thus, draw line PM on base QR in which PM divides QR into two equal parts.

Here, $QM = \frac{x}{2} = MR$

Now in right angled triangle ΔPMR , $\angle R = 60^\circ$;
 $\angle M = 90^\circ$ then $\angle MPR = 30^\circ$

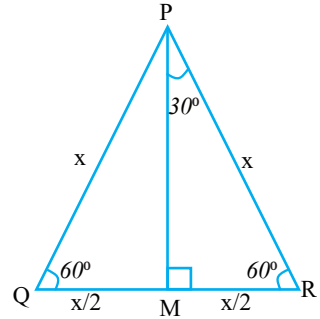

By Pythagoras theorem in ΔPMR ,

$$(PM)^2 = (PR)^2 - (MR)^2$$

$$(PM)^2 = x^2 - \left(\frac{x}{2}\right)^2 = x^2 - \frac{x^2}{4}$$

$$(PM)^2 = \frac{3x^2}{4}$$

$$PM = \sqrt{\frac{3x^2}{4}} = \frac{\sqrt{3}}{2}x$$

Now, $\angle MPR = 30^\circ$ then $\frac{p}{h} = \frac{MR}{PR} = \frac{\frac{x}{2}}{x}$, $h = PR = x$, $b = PM = \frac{\sqrt{3}x}{2}$

$$\sin 30^\circ = \frac{p}{h} = \frac{MR}{PR} = \frac{\frac{x}{2}}{x} = \frac{x}{2} \times \frac{1}{x} = \frac{1}{2} = 0.5$$

$$\cos 30^\circ = \frac{b}{h} = \frac{PM}{PR} = \frac{\frac{\sqrt{3}}{2}x}{x} = \frac{\sqrt{3}}{2} = 0.866$$

$$\tan 30^\circ = \frac{p}{b} = \frac{\frac{x}{2}}{\frac{\sqrt{3}}{2}x} = \frac{x}{2} \times \frac{2}{\sqrt{3}x} = \frac{1}{\sqrt{3}} = 0.577$$

Similarly, find the value of $\operatorname{cosec} 30^\circ$, $\sec 30^\circ$ and $\cot 30^\circ$ based on above values.

Again in right angled triangle PMR, taking the reference angle $\angle R = 60^\circ$

$$\sin 60^\circ = \frac{p}{h} = \frac{PM}{PR} = \frac{\frac{\sqrt{3}}{2}x}{x} = \frac{\sqrt{3}x}{2} \times \frac{1}{x} = \frac{\sqrt{3}}{2}$$

$$\cos 60^\circ = \frac{b}{h} = \frac{\frac{x}{2}}{x} = \frac{x}{2} \times \frac{1}{x} = \frac{1}{2} = 0.5$$

$$\tan 60^\circ = \frac{p}{b} = \frac{\frac{\sqrt{3}x}{2}}{\frac{x}{2}} \times \frac{1}{x} = \sqrt{3} = 1.732$$

Similarly, find the value of cosec 60° , sec 60° and cot 60° on the basis of above values. cosec 60° .

Note: In this way, $\sin 30^\circ = \frac{1}{2} = \cos 60^\circ = \cos (90^\circ - 30^\circ)$

$$\therefore \sin \theta = \cos (90^\circ - \theta)$$

Similarly, $\cos 30^\circ = \frac{\sqrt{3}}{2} = \sin 60^\circ = \sin (90^\circ - 60^\circ)$

$$\cos \theta = \sin (90^\circ - \theta)$$

(c) Trigonometric value of angle 0° and 90°

Angled triangle PQR, if we rotate the side RP, then the length of side PQ being continuously decreased and at last the point P overlaps with point Q, and thus, the line PR and QR completely overlap to each other.

In this situation, $\angle PRQ$ is going to decrease at $PQ = 0$, $PR = QR$

$$\sin 0^\circ = \frac{PQ}{PR} = \frac{0}{x} = 0$$

$$\cos 0^\circ = \frac{QR}{PR} = \frac{x}{x} = 1$$

$$\tan 0^\circ = \frac{PQ}{QR} = \frac{0}{x} = 0$$

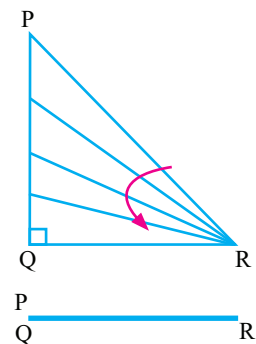

Similarly in triangle PQR, if we increase $\angle PRQ$ to 90° , i. e. $\angle PRQ = 90^\circ$, then $PQ = PR$.

That is, $PQ = x$ implies $PR = x$ and $QR = 0$.

$$\sin 90^\circ = \frac{PQ}{PR} = \frac{x}{x} = 1$$

$$\cos 90^\circ = \frac{QR}{PR} = \frac{0}{x} = 0$$

$$\tan 90^\circ = \frac{PQ}{QR} = \frac{x}{0} (\infty, \text{undefined})$$

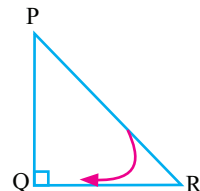

Activity 3

Trigonometric values of standard angles in unit circle

Draw a circle with centre O using compass having radius 1 inch.

Take a point P(x, y) in the circumference of the circle.

Rotate line OP in anti-clockwise direction.

Draw perpendicular PQ on x-axis from point P.

Now in right angled triangle OPQ, write the trigonometric

ratios of $\sin \theta$, $\cos \theta$ and $\tan \theta$ taking $\angle POQ = \theta$ as a reference angle.

$$\sin \theta = \frac{y}{OP}, \cos \theta = \frac{x}{OP}, \text{ \& } \tan \theta = \frac{y}{x}$$

Now, find the value of trigonometric ratios making angles 30° , 45° , 60° , 90° with x-axis on rotating the line OP in anti-clockwise direction.

The values of different trigonometric ratios of standard angles: like $\sin 0^\circ$, $\sin 30^\circ$, $\sin 45^\circ$, $\sin 60^\circ$, $\sin 90^\circ$, are given in the following table:

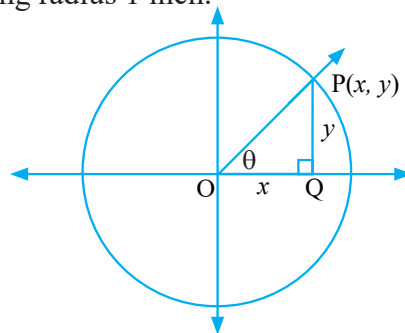

Angle Ratios	0°	30°	45°	60°	90°
	0	$\frac{1}{2}$	$\frac{1}{\sqrt{2}}$	$\frac{\sqrt{3}}{2}$	1
	1	$\frac{\sqrt{3}}{2}$	$\frac{1}{\sqrt{2}}$	$\frac{1}{2}$	0
tan	0	$\frac{1}{\sqrt{3}}$	1	$\sqrt{3}$	∞ , infinite

Note: Methods of remembering the value of standard angles of trigonometric ratios

Write numbers from 0 to 4 respectively. Divide all the numbers by 4. And find the square root of the entire fraction. Then obtained values are the values of $\sin 0^\circ$, $\sin 30^\circ$, $\sin 45^\circ$, $\sin 60^\circ$ and $\sin 90^\circ$.

Example 1

Find the values of the following trigonometric ratios:

(a) $\sin 45^\circ + \cos 45^\circ$

(b) $\frac{\cos 30^\circ}{\sin 30^\circ}$

Solution:

(a) $\sin 45^\circ + \cos 45^\circ = \frac{1}{\sqrt{2}} + \frac{1}{\sqrt{2}} = \frac{2}{\sqrt{2}} = \frac{\sqrt{2} \times \sqrt{2}}{\sqrt{2}} = \sqrt{2}$

(b) $\frac{\cos 30^\circ}{\sin 30^\circ} = \frac{\frac{\sqrt{3}}{2}}{\frac{1}{2}} = \sqrt{3}$

Example 2

From the given right angled triangle, find the perpendicular and base if reference angle is 60° and length of hypotenuse is 20 ft:

Solution:

Given, in right angled triangle ABC, reference angle $\angle C = \theta$, i. e. $\theta = 60^\circ$ and hypotenuse AC (h) = 20 ft, base (b) = ? and perpendicular (p) = ?

We know that, $\sin \theta = \frac{p}{h}$

or, $\sin 60^\circ = \frac{p}{20}$

or, $\frac{\sqrt{3}}{2} = \frac{p}{20}$

or, $p = 10\sqrt{3}$ ft

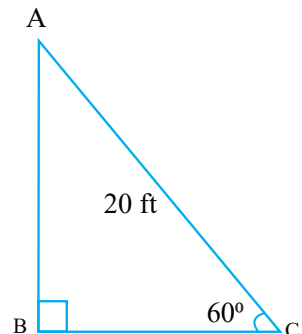

$$\text{Again, } h^2 = p^2 + b^2$$

$$b^2 = h^2 - p^2$$

$$= 20^2 - (10\sqrt{3})^2$$

$$= 400 - 300$$

$$= 100$$

$$b = \sqrt{100} = \sqrt{10 \times 10} = 10 \text{ ft}$$

Example 3

A straight tree of 30 m height is broken so that its top touches the ground and makes an angle 45° . Find the original height of the tree.

Solution:

Here, reference angle $(\theta) = 45^\circ$

Base $(b) = 30 \text{ m}$

Original height of tree $(H) = ?$

We know that, $\cos\theta = \frac{b}{h}$ and $\tan\theta = \frac{p}{b}$

$$\text{or, } \cos 45^\circ = \frac{30}{h} \text{ and } \tan 45^\circ = \frac{p}{30}$$

$$\text{or, } \frac{1}{\sqrt{2}} = \frac{30}{h} \text{ and } 1 = \frac{p}{30}$$

$$\text{or, } h = 30\sqrt{2} \text{ and } p = 30$$

$$\text{Thus, the original height of the tree } (H) = h + p = 30\sqrt{2} + 30 = 30(\sqrt{2} + 1)$$

$$= 30 \times (1.4142 + 1)$$

$$= 30 \times 2.4142$$

$$= 72.426 \text{ m}$$

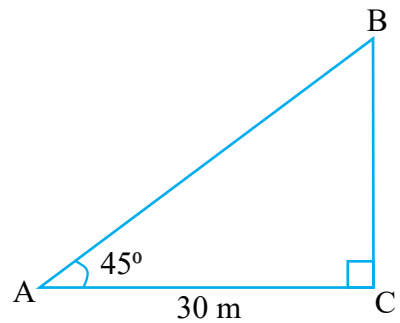

Exercise 20.3

1. Find the value of the following trigonometric ratios:

(a) $\sin 90^\circ$ (b) $\cos 60^\circ$ (c) $\tan 30^\circ$

(d) $\cot 45^\circ$ (e) $\operatorname{cosec} 45^\circ$

2. Find the value of reference angles of the given right angled triangles from the following problems:

(a) $p = 4$ cm and $b = 4\sqrt{3}$ cm (b) $p = 7\sqrt{3}$ ft and $h = 14$ ft

(c) $b = 5$ cm and $h^2 = 50$ cm² (d) $p = x$ inch and $b = x$ inch

3. Find the remaining side of the given right angled triangles:

(a) Length of hypotenuse 10 cm and reference angle is 60° .

(b) Length of perpendicular 10 cm and reference angle is 45°

(c) Length of base 36 inch and reference angle is 30° .

4. Find the value of the following trigonometric expressions:

(a) $\sin 30^\circ + \cos 60^\circ$

(b) $\tan 30^\circ + \sin 60^\circ$

(c) $\sin 30^\circ + \cos 30^\circ \times \tan 30^\circ$

(d) $\frac{\sin 60^\circ + \cos 30^\circ}{\tan 60^\circ}$

5. Prove that:

(a) $\cos^2 45^\circ + \sin^2 45^\circ = 1$

(b) $\frac{2\tan 30^\circ}{1 - \tan^2 30^\circ} = \tan 60^\circ$

(c) $\frac{\tan 60^\circ - \tan 30^\circ}{1 + \tan 60^\circ \tan 30^\circ} = \tan 30^\circ$

(d) $\tan 45^\circ - \sin 90^\circ = 1 - 2 \sin^2 45^\circ$

6. (a) Find the angle formed by the ladder with the ground and the wall respectively in the given figure.

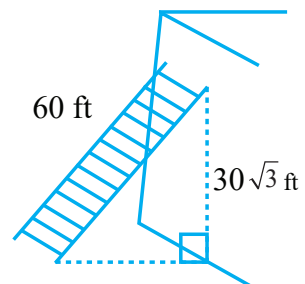

- (b) Find the angle of the top of a clock tower of height 36 m observed from a point $12\sqrt{3}$ m away.
- (c) In the given figure,
- What may be the value of x , if both angles are of acute angle 45° ?
 - What is the measurement of VJ ?

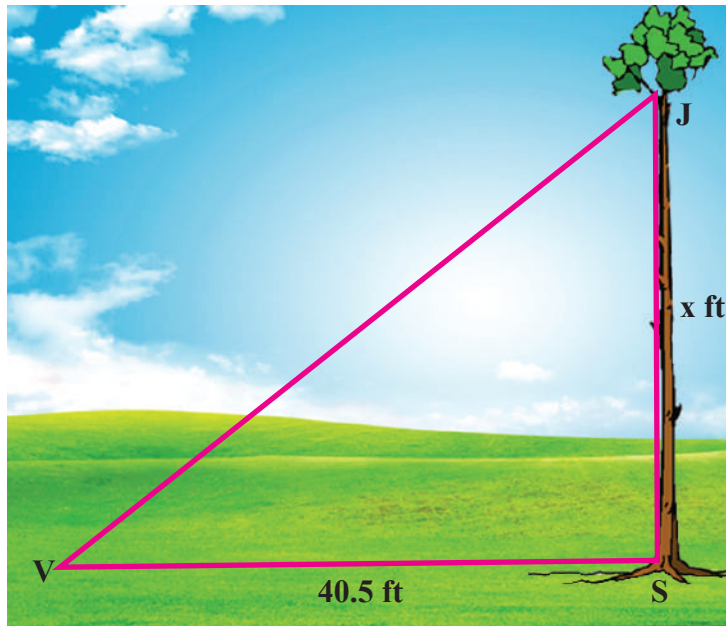

- (d) A ladder is supported by a wall of 12 ft height and makes an angle of 60° with a ground. Find the length of the ladder.

Project work

Take a long thread. Tie one end of the thread to a pole standing on the ground. Then fix another end of thread in different places of the ground that makes the angles 30° , 45° , 60° and 90° . Find different trigonometric ratios: sin, cos and tan based on the distance between pole and the thread tied on the ground as well length of the thread.

Answer

1. (a) 1 (b) $\frac{1}{2}$ (c) $1/\sqrt{3}$ (d) 1 (e) $\sqrt{2}$
2. (a) 30° (b) 60° (c) 45° (d) 90°
3. (a) $p = 5\sqrt{3}$, $b = 5$ (c) $b = 15$, $h = 15\sqrt{2}$ (d) $p = 12\sqrt{3}$, $h = 24\sqrt{3}$
4. (a) 1 (b) $5/2\sqrt{3}$ (c) 1 (d) 1
5. Show the answer to your teacher.
6. (a) 60° and 30° (b) 30° (c) (i) 40.5 ft (ii) 57.28 ft (d) $8\sqrt{3}$

Mixed Exercise

1. Answer the following questions based on the given figure:

- (a) Determine perpendicular, base and hypotenuse taking as reference angle $\angle B$.
- (b) Find the 6 trigonometric ratios based on (a).
- (c) If $h = 20$ and $b = 12$, then find the value of $\tan B$.
- (d) Find the value of $\sin^2 B$, $\cos^2 B$ and $\tan^2 B$ on the basis of (c).

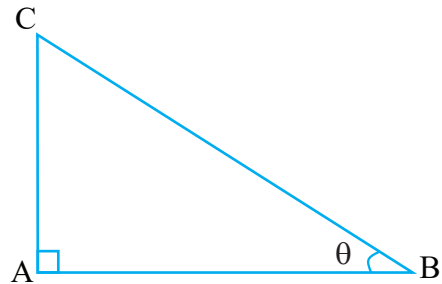

2. Answer the following questions based on the given right angled triangle:

- (a) Find the value of XY and ZX .
- (b) Prove that: $\sin^2 X + \cos^2 X = 1$.
- (c) Find the value of $\sin Z$, $\cos Z$ and $\tan Z$.
- (d) Find the value of $\sin^2 B$, $\cos^2 B$ and $\tan^2 B$ on the basis of (c).

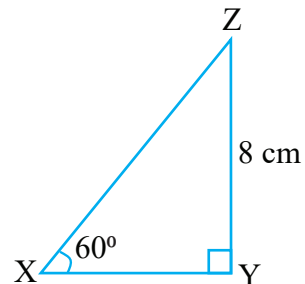

3. (a) Top of a bamboo tree makes an angle of 30° from a distance 30 ft of ground level, and then what is the height of the bamboo tree?
- (b) How long distance should be travelled from the bamboo tree to make an angle of 45° ?
- (c) If the bamboo tree grows up to $30\sqrt{3}$ ft after 4 days, then what angle does the top of the tree from the initial point make?

Answer

- 1-2. Show the answers to your teacher. 3. (a) $10\sqrt{3}$ ft
(b) 12.68 ft (c) 60°

